



Outdoor **2017**





## INTRODUCTION

01 CONTENT



## OUTDOOR

02 CONTEMPORARY



58 AUTHENTIC



104 FUNCTION



128 INTERFACE



142 EASYDIM



## TECHNICAL DETAILS / INDEX

144 TECHNICAL DETAILS



149 TERMS / INDEX







# CONTEMPORARY



1-4



1-4



2,4

## Panel

black  
aluminium/glass

### 1. G42681/06

‡ 255mm ↔100mm  
→165mm ø  
LED integr., 1 x 9W   
1 x 600 lm, 3000 K, **A**



4 004353 229244

### 2. G42697/06

‡ 256mm ↔100mm  
→165mm ø  
LED integr., 1 x 9W   
1 x 600 lm, 3000 K, **A**



4 004353 229251

### 3. G42684/06

‡ 500mm ↔100mm  
→135mm ø  
LED integr., 1 x 9W   
1 x 600 lm, 3000 K, **A**



4 004353 229268

### 4. G42689/06

‡ 500mm ↔100mm  
→135mm ø  
LED integr., 1 x 9W   
1 x 600 lm, 3000 K, **A**



4 004353 229275



1

600  
LUMEN



2

600  
LUMEN



3

600  
LUMEN



4

600  
LUMEN

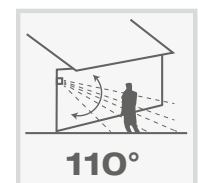

110°



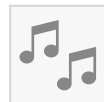

## Shiso

anthracite/white  
metal/plastic

### 1. G44597/63

↑ 175mm ↔ 85mm  
→ 140mm ø  
LED integr., 1 x 7W   
1 x 630 lm, 3000 K, **A+**



### 2. G44584/63

↑ 500mm ↔  
→ ø 75mm  
LED integr., 1 x 7W   
1 x 630 lm, 3000 K, **A+**



### 3. G44585/63

↑ 800mm ↔  
→ ø 75mm  
LED integr., 1 x 7W   
1 x 630 lm, 3000 K, **A+**



### 4. G44581/63

↑ 135mm ↔  
→ 140mm ø 75mm  
LED integr., 1 x 7W   
1 x 630 lm, 3000 K, **A+**



### 5. G44594/63

↑ 183mm ↔ 85mm  
→ 140mm ø  
LED integr., 1 x 7W   
1 x 630 lm, 3000 K, **A+**

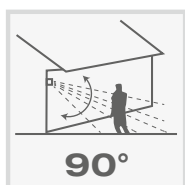





**LED**  
incl.

1-3

**IP54**  

1-3

## Derek

anthracite  
metal/plastic

### 1. G66580/63

↑ 100mm ↔ 80mm

→ 185mm ∅

LED integr., 1 x 3,6W 

1 x 290 lm, 4000 K, 





290  
LUMEN

### 2. G66585/63

↑ 600mm ↔ 80mm

→ 185mm ∅

LED integr., 1 x 3,6W 

1 x 290 lm, 4000 K, 





290  
LUMEN

### 3. G66586/63

↑ 1000mm ↔ 80mm

→ 185mm ∅

LED integr., 1 x 3,6W 

1 x 290 lm, 4000 K, 



290  
LUMEN



1-2



1-2



1

## Ashton

black  
metal/plastic

### 1. G41681/06

‡ 150mm ↔ 50mm  
→150mm ∅  
LED integr., 1 x 4,3W   
1 x 250 lm, 3000 K,



1



### 2. G41685/06

‡ 600mm ↔ 50mm  
→150mm ∅  
LED integr., 1 x 3,6W   
1 x 200 lm, 3000 K,



2



**LED**  
incl.  
1-2

**IP44**  
1-2

## Orco

anthracite/white  
metal/plastic

### 1. G96244/63

↑ 315mm ↔  
→ 160mm ø 105mm  
LED integr., 1 x 9W   
1 x 590 lm, 4000 K, **A**



### 2. G96245/63

↑ 650mm ↔  
→ ø 120mm  
LED integr., 1 x 9W   
1 x 590 lm, 4000 K, **A**



**LED**  
incl.

1-2

**IP44**  
☔

1-2

## Travis

anthracite/white plastic

### 1. G96305/63

‡ 212mm ↔ 165mm

→ 118mm ø

LED integr., 1 x 6W

1 x 500 lm, 4200 K, **A+**



1



500  
LUMEN

## Harper

anthracite/white plastic

### 2. G96306/63

‡ 236mm ↔ 108mm

→ 88mm ø

LED integr., 1 x 6W

1 x 500 lm, 4200 K, **A+**



2



500  
LUMEN



1-2



1-2



1

## Casting

anthracite  
metal/plastic

### 1. G96258/63

↑ 65mm ↔140mm  
→130mm ø  
LED integr., 1 x 7W   
1 x 600 lm, 3000 K, **A+**



4 004353 229282

1



600  
LUMEN

## Zen

anthracite/white  
aluminium/plastic

### 2. G96246/63

↑ ↔  
→55mm ø 180mm  
LED integr., 1 x 9W   
1 x 740 lm, 3000 K, **A+**



4 004353 206238

2



740  
LUMEN





1-2



1-2



2

## Archea

black/white  
metal/plastic

### 1. G96239/06

↑ 180mm ↔ 140mm  
→ 110mm ∅  
LED integr., 1 x 8,8W   
1 x 800 lm, 3000 K, **A+**



4 004353 206122

## Arco

black  
aluminium/plastic

### 2. G96249/06

↑ 58mm ↔ 135mm  
→ 140mm ∅  
LED integr., 1 x 4W   
1 x 120 lm, 3000 K



4 004353 207150



1

800  
LUMEN



2

120  
LUMEN

**LED**  
incl.

1-2

**IP44**  



1-2

## Warren

black/silver  
metal/plastic

### 1. G96251/06



‡ 65mm ↔125mm  
→130mm ∅

LED integr., 1 x 2,4W   
1 x 192 lm, 6500 K, 



### 2. G96251/58

‡ 65mm ↔125mm  
→130mm ∅

LED integr., 1 x 2,4W   
1 x 192 lm, 6500 K, 



1



192  
LUMEN

2



192  
LUMEN



**LED**  
incl.

**IP44**  



## Mathis

grey/milk glass  
aluminium/glass

### 1. G96250/22

↑ ↓     ↔  
→110mm    ø 200mm

LED, G9, 1 x 3W 

1 x 250 lm, 3000 K, 

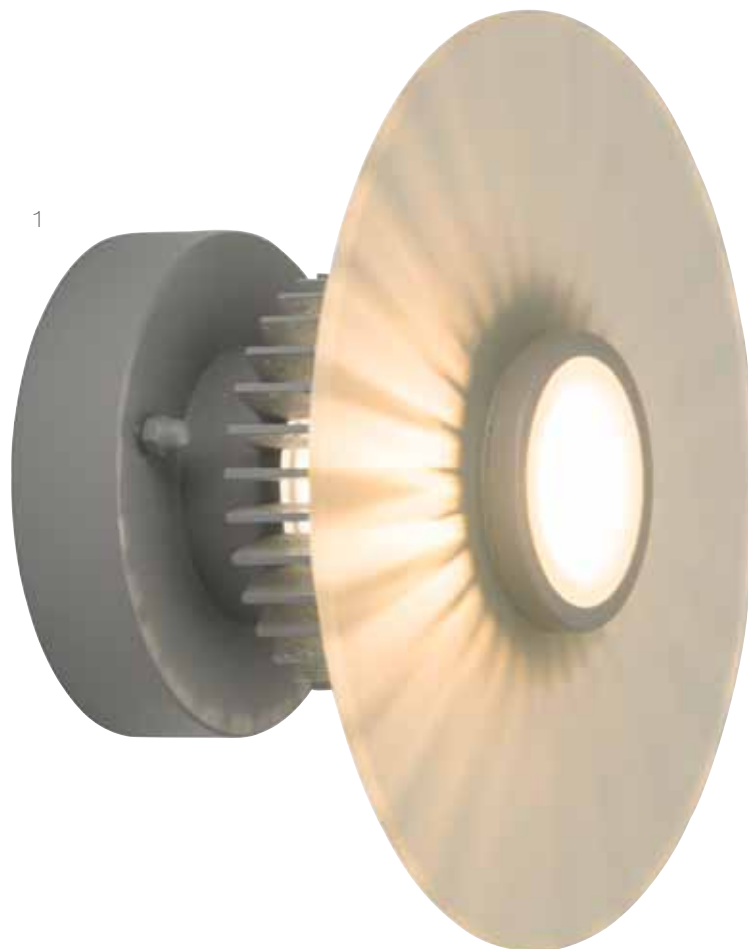

**250**  
LUMEN

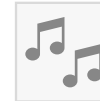

## Music

satin nickel/white  
metal/plastic

### 1. G94403/13

↑ 105mm ↔ 85mm

→ 125mm ∅

LED integr., 1 x 3W 

1 x 230 lm, 3000-6000 K, 



230  
LUMEN



1

For use **In-** and **Outdoor**,  
colour temperature: **warm white**,  
**high** soundquality, **IP 44**, free **App**





1-4



1-4



4

## Arctic

high-grade steel/transparent metal/plastic

### 1. G96302/82

↑ 250mm ↔  
→ 118mm ø 85mm  
LED integr., 1 x 6,5W   
1 x 480 lm, 4000 K, **A+**



4 004353 259692

### 2. G96303/82

↑ 500mm ↔  
→ 118mm ø 85mm  
LED integr., 1 x 6,5W   
1 x 480 lm, 4000 K, **A+**



4 004353 259708

### 3. G96304/82

↑ 800mm ↔  
→ 118mm ø 85mm  
LED integr., 1 x 6,5W   
1 x 480 lm, 4000 K, **A+**



4 004353 259715

### 4. G96285/82

↑ 250mm ↔  
→ 118mm ø 85mm  
LED integr., 1 x 7,2W   
1 x 480 lm, 4000 K, **A+**



4 004353 256363



CONTEMPORARY



**LED**  
incl.

1 - 4

**IP44**  
☔

1 - 4

## Avon

high-grade steel  
high-grade steel/plastic

### 1. G43480/82

↑ 195mm ↔  
→ 120mm ø 75mm  
LED integr., 30 x 0,2W ☑  
1 x 180 lm, 6500 K



1

180  
LUMEN

### 2. G43481/82

↑ 150mm ↔  
→ 130mm ø 75mm  
LED integr., 30 x 0,2W ☑  
1 x 180 lm, 6500 K



2

180  
LUMEN

### 3. G43484/82

↑ 300mm ↔  
→ ø 75mm  
LED integr., 30 x 0,2W ☑  
1 x 180 lm, 6500 K



3

180  
LUMEN

### 4. G43485/82

↑ 500mm ↔  
→ ø 75mm  
LED integr., 30 x 0,2W ☑  
1 x 180 lm, 6500 K



4



180  
LUMEN



1-4



1-4



2

## Bergen

anthracite/transparent  
metal/plastic

### 1. G40081/63

↑ 220mm ↔  
→ 110mm ø 60mm  
LED, GU10, 1 x 4W   
1 x 345 lm, 4000 K, **A+**  
↗ 98329/63



4 004353 251849

### 2. G40097/63

↑ 292mm ↔  
→ 110mm ø 60mm  
LED, GU10, 1 x 4W   
1 x 345 lm, 4000 K, **A+**  
↗ 98329/63



4 004353 251856

### 3. G40084/63

↑ 400mm ↔  
→ ø 60mm  
LED, GU10, 1 x 4W   
1 x 345 lm, 4000 K, **A+**  
↗ 98329/63



4 004353 251870

### 4. G40085/63

↑ 800mm ↔  
→ ø 60mm  
LED, GU10, 1 x 4W   
1 x 345 lm, 4000 K, **A+**  
↗ 98329/63



4 004353 251894

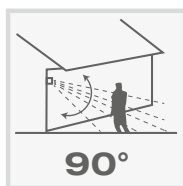



1-4



1-4



2

## Bergen

high-grade steel/transparent  
metal/plastic

### 1. G40081/82

↑ 220mm ↔  
→ 110mm ø 60mm  
LED, GU10, 1 x 4W   
1 x 345 lm, 4000 K, **A+**  
↗ 98329/00



4 004353 251757

### 2. G40097/82

↑ 292mm ↔  
→ 110mm ø 60mm  
LED, GU10, 1 x 4W   
1 x 345 lm, 4000 K, **A+**  
↗ 98329/00



4 004353 251832

### 3. G40084/82

↑ 400mm ↔  
→ 110mm ø 60mm  
LED, GU10, 1 x 4W   
1 x 345 lm, 4000 K, **A+**  
↗ 98329/00



4 004353 251863

### 4. G40085/82

↑ 800mm ↔  
→ 110mm ø 60mm  
LED, GU10, 1 x 4W   
1 x 345 lm, 4000 K, **A+**  
↗ 98329/00



4 004353 251887

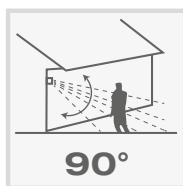

1

345  
LUMEN



2

345  
LUMEN



3

345  
LUMEN



4

345  
LUMEN







1-4



1-4



1-4



1-4

## Bole

high-grade steel/ white metal/plastic

### 1. G96131/82

↑ 380mm ↔  
→ 150mm ø 75mm  
A60, E27, 1 x 60W  
LED integr., 12 x 0.07W ☑



### 2. G46798/82

↑ 440mm ↔  
→ 220mm ø 75mm  
A60, E27, 1 x 60W  
LED integr., 12 x 0.07W ☑



### 3. G46789/82

↑ 500mm ↔  
→ ø 75mm  
A60, E27, 1 x 60W  
LED integr., 12 x 0.07W ☑



### 4. G46799/82

↑ 775mm ↔  
→ ø 75mm  
A60, E27, 1 x 60W  
LED integr., 12 x 0.07W ☑

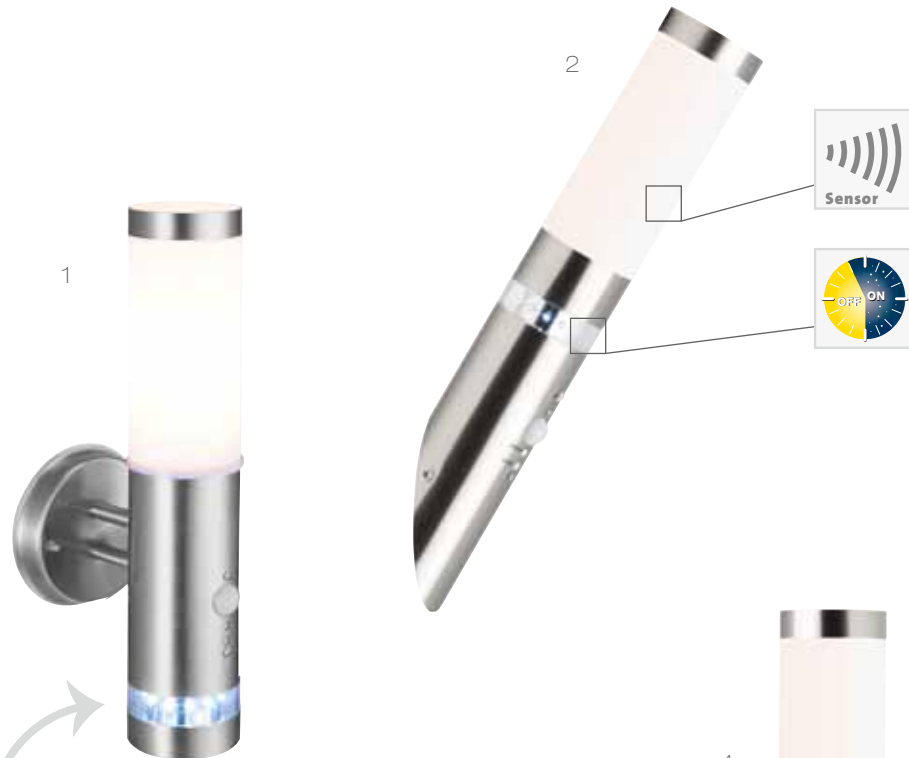

LED schaltet sich bei Dämmerung und Dunkelheit automatisch ein.

LED Daylight sensor turns on automatically by darkness

Le cercle LED s'allume automatiquement dans l'obscurité

Accensione LED con sensor crepuscolare.

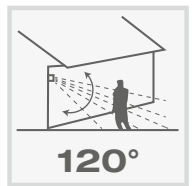





1



1-3



3

## Adonia

high-grade steel/white  
high-grade steel/plastic

### 1. G96228/82

‡ 400mm ↔  
→180mm ø 75mm  
LED, E27, 1 x 3,3W   
1 x 250 lm, 3000 K, **A+**  
↗92571/05



4 004353 189876

## Chorus

high-grade steel/white  
high-grade steel/plastic

### 2. 43681/82

‡ 360mm ↔  
→180mm ø 75mm  
TC-TSE, E27, 1 x 20W  
↗92571/05



4 004353 993190

### 3. 43697/82

‡ 400mm ↔  
→180mm ø 75mm  
TC-TSE, E27, 1 x 20W  
↗92571/05



4 004353 031427



1

250  
LUMEN



2



3

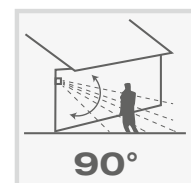

90°



## Chorus

high-grade steel/white  
high-grade steel/plastic

### 1. 43684/82

↑ 500mm ↔  
→ ø 75mm  
TC-TSE E27 1 x 20W  
♣92571/05



### 2. 43693/82

↑ 460mm ↔  
→ ø 75mm  
TC-TSE, E27, 1 x 20W  
♣98207/05



### 3. 43685/82

↑ 800mm ↔  
→ ø 75mm  
TC-TSE, E27, 1 x 20W  
♣92571/05



### 4. 43699/82

↑ 800mm ↔  
→ ø 75mm  
TC-TSE, E27, 1 x 20W  
♣92571/05

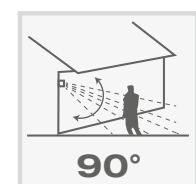



1-3

## Finnigan

high-grade steel  
high-grade steel/plastic

### 1. G43281/82

↑ 185mm ↔  
→ 180mm ø 100mm  
TC-DSE, E27, 1 x 9W



### 2. G43284/82

↑ 500mm ↔  
→ ø 100mm  
TC-DSE, E27, 1 x 9W



### 3. G43285/82

↑ 800mm ↔  
→ ø 100mm  
TC-DSE, E27, 1 x 9W



1

3



2





1-3

## Madison

high-grade steel/white  
high-grade steel/plastic

### 1. 47281/82

‡ 280mm ↔ 200mm  
→ 230mm ø 200mm  
A60, E27, 1 x 60W



### 2. 47284/82

‡ 500mm ↔  
→ ø 200mm  
A60, E27, 1 x 60W



### 3. 47285/82

‡ 1010mm ↔  
→ ø 200mm  
A60, E27, 1 x 60W





1-4



1-4



2

## Aalborg LED

high-grade steel/white  
high-grade steel/glass

### 1. G44081/82

‡ 320mm ↔  
→ 220mm ø  
LED, E27, 1 x 5,8W   
1 x 630 lm, 2700 K, **A++**  
92216/92



4 004353 230479

### 2. G44097/82

‡ 320mm ↔  
→ 220mm ø  
LED, E27, 1 x 5,8W   
1 x 630 lm, 2700 K, **A++**  
92216/92, 92437/06



4 004353 230486

### 3. G44084/82

‡ 440mm ↔  
→ ø 200mm  
LED, E27, 1 x 5,8W   
1 x 630 lm, 2700 K, **A++**  
92216/92



4 004353 230493

### 4. G44085/82

‡ 1050mm ↔  
→ ø 200mm  
LED, E27, 1 x 5,8W   
1 x 630 lm, 2700 K, **A++**  
92216/92



4 004353 230509

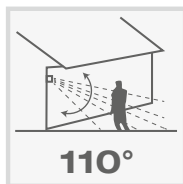

110°

1



630  
LUMEN

4



630  
LUMEN

2



630  
LUMEN

3



630  
LUMEN





## Aalborg

high-grade steel/ white  
high-grade steel/glass

### 1. 44081/82

↑ 320mm ↔  
→ 220mm ∅  
A60, E27, 1 x 60W  
/ 92216/92



### 2. 44097/82

↑ 320mm ↔  
→ 220mm ∅  
A60, E27, 1 x 60W  
/ 92216/92, 92437/06



### 3. 44084/82

↑ 440mm ↔  
→ ∅ 200mm  
A60, E27, 1 x 60W  
/ 92216/92



### 4. 44085/82

↑ 1050mm ↔  
→ ∅ 200mm  
A60, E27, 1 x 60W  
/ 92216/92

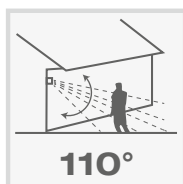

1



4



2



3





## York

high-grade steel  
high-grade steel/plastic

### 1. 44781/82

↑ 320mm ↔  
→ 220mm ø 200mm  
A60, E27, 1 x 60W



### 2. 44797/82

↑ 320mm ↔  
→ 220mm ø 200mm  
A60, E27, 1 x 60W  
/92437/06



### 3. 44784/82

↑ 400mm ↔  
→ ø 200mm  
A60, E27, 1 x 60W



### 4. 44785/82

↑ 1000mm ↔  
→ ø 200mm  
A60, E27, 1 x 60W



### 5. 44799/82

↑ 1000mm ↔  
→ ø 200mm  
A60, E27, 1 x 60W  
/92437/06

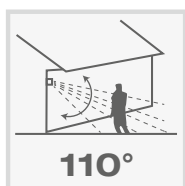

1



2



3



4



5



IP44  
1 - 4

## Neil

high-grade steel  
metal/plastic

### 1. 40381/82

↑ 320mm ↔  
→ 210mm ø 170mm  
A60, E27, 1 x 60W



### 2. 40382/82

↑ 320mm ↔  
→ 210mm ø 170mm  
A60, E27, 1 x 60W



### 3. 40384/82

↑ 500mm ↔  
→ ø 170mm  
A60, E27, 1 x 60W



### 4. 40385/82

↑ 900mm ↔  
→ ø 170mm  
A60, E27, 1 x 60W





1-3

## Terrence

high-grade steel  
metal/glass

### 1. 45781/82

↑ 250mm ↔  
→ 260mm ø 220mm  
A60, E27, 1 x 60W  
92438/00



1



3



### 2. 45784/82

↑ 500mm ↔  
→ ø 220mm  
A60, E27, 1 x 60W  
92438/00



2



### 3. 45785/82

↑ 900mm ↔  
→ ø 220mm  
A60, E27, 1 x 60W  
92438/00





1-2



2

## Severin

high-grade steel  
high-grade steel/plastic

### 1. 96181/82

‡ 300mm ↔  
→210mm ø 180mm  
A60, E27, 1 x 40W



### 2. 96157/82

‡ 300mm ↔  
→210mm ø 180mm  
A60, E27, 1 x 40W

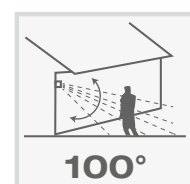



1-3



2

## Todd

high-grade steel/white metal/plastic

### 1. 47682/82

‡ 290mm ↔ 230mm  
→ 90mm ø  
A60, E27, 1 x 60W



1

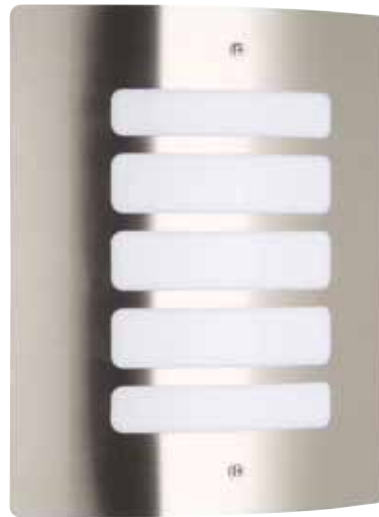

### 2. 47698/82

‡ 290mm ↔ 230mm  
→ 90mm ø  
A60, E27, 1 x 60W



3



### 3. 47684/82

‡ 400mm ↔ 165mm  
→ 70mm ø  
TC-TSE, E27, 1 x 20W



2

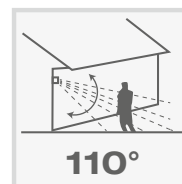



## Todd

high-grade steel/white  
high-grade steel/plastic

1.47685/82 ☺

‡ 1000mm ↔ 165mm  
→ 70mm ø

TC-TSE, E27, 1 x 20W





1 - 4



2

## Todd

charcoal grey/white  
metal/plastic

### 1. 47682/63

↓ 290mm ↔ 230mm  
→ 90mm ø  
A60, E27, 1 x 60W



4 004353 121319

### 2. 47698/63

↓ 290mm ↔ 230mm  
→ 90mm ø  
A60, E27, 1 x 60W



4 004353 121395

### 3. 47684/63

↓ 400mm ↔ 165mm  
→ 70mm ø  
TC-TSE, E27, 1 x 20W



4 004353 121333

### 4. 47685/63

↓ 1000mm ↔ 165mm  
→ 70mm ø  
TC-TSE, E27, 1 x 20W



4 004353 121364

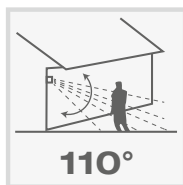

1



2



3



4







1-4



2

## Todd

white  
metal/plastic

### 1. 47682/05

‡ 290mm ↔ 230mm  
→ 90mm ø  
A60, E27, 1 x 60W



1



### 2. 47698/05

‡ 290mm ↔ 230mm  
→ 90mm ø  
A60, E27, 1 x 60W



2



### 3. 47684/05

‡ 400mm ↔ 165mm  
→ 70mm ø  
TC-TSE, E27, 1 x 20W



3



### 4. 47685/05

‡ 1000mm ↔ 165mm  
→ 70mm ø  
TC-TSE, E27, 1 x 20W



4

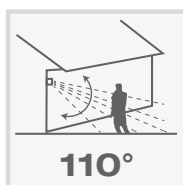



## Gap

anthracite/white  
metal/plastic

### 1. 43580/63

‡ 400mm ↔  
→200mm ø 75mm  
TC-TSE, E27, 1 x 20W



### 2. 43597/63

‡ 400mm ↔  
→200mm ø 75mm  
TC-TSE, E27, 1 x 20W



### 3. 43585/63

‡ 800mm ↔  
→ ø 75mm  
TC-TSE, E27, 1 x 20W

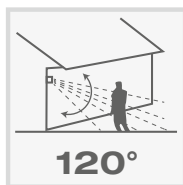



## Gap

anthracite/white  
metal/plastic

1.43584/63 ☺

‡ 500mm ↔

→ ø 75mm

TC-TSE, E27, 1 x 20W



IP44

1 - 2

## Berna

black  
die-cast aluminium/plastic

### 1. 41081/06

‡ 420mm ↔  
→ 360mm ø 260mm  
A60, E27, 1 x 60W



### 2. 41087/06

‡ 2050mm ↔  
→ 740mm ø 260mm  
A60, E27, 2 x 60W

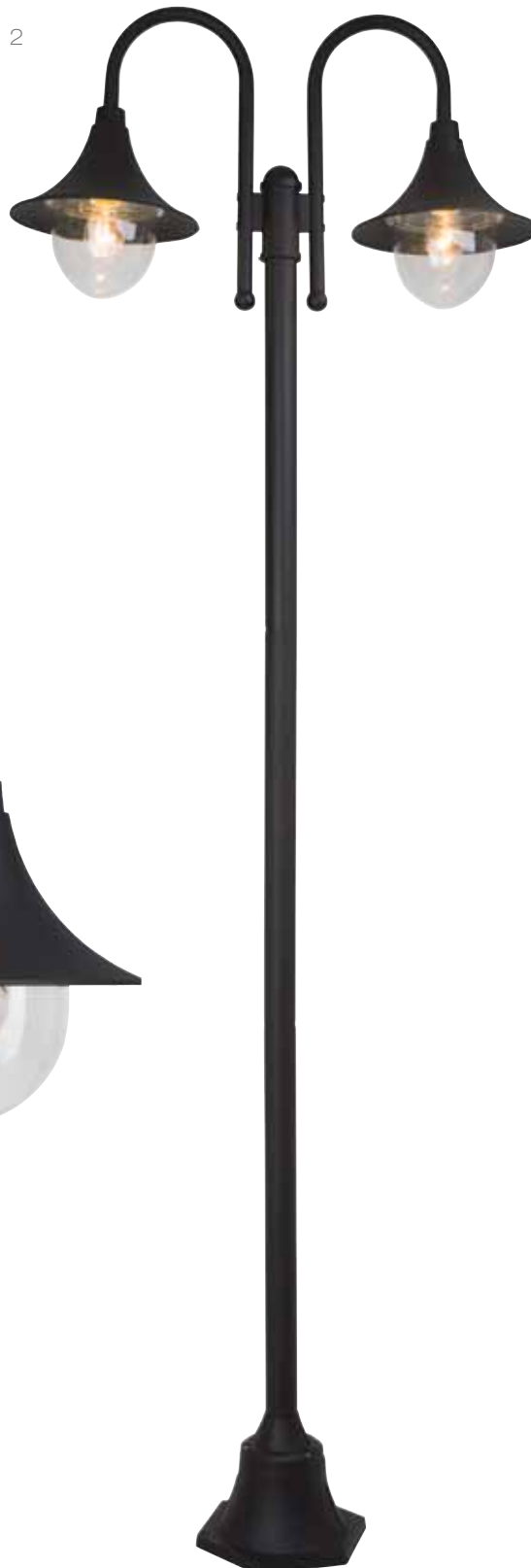

2



1



## Berna

black  
die-cast aluminium/plastic

1.41070/06 ☺

‡ 910mm ↔  
→ ø 260mm  
A60, E27, 1 x 60W



IP44  

1 - 2

## Hollywood

black  
die-cast aluminium/plastic

### 1. 47880/06

↑ 240mm ↔ 235mm  
→ 130mm ∅  
A60, E27, 1 x 60W  
↗ 98041/00



1



### 2. 47884/06

↑ 350mm ↔  
→ ∅ 230mm  
A60, E27, 1 x 60W  
↗ 98042/00



2





1 - 4



2

## Hollywood

white  
die-cast aluminium/plastic

### 1. 47880/05

↑ 240mm ↔ 235mm  
→ 130mm ∅  
A60, E27, 1 x 60W  
↗ 98041/00



4 004353 164736

### 2. 47897/05

↑ 240mm ↔ 235mm  
→ 130mm ∅  
A60, E27, 1 x 60W  
↗ 98041/00



4 004353 164781

### 3. 47884/05

↑ 350mm ↔  
→ ∅ 230mm  
A60, E27, 1 x 60W  
↗ 98042/00



4 004353 164750

### 4. 47885/05

↑ 960mm ↔  
→ ∅ 230mm  
A60, E27, 1 x 60W  
↗ 98042/00



4 004353 164774

1



2



3



4

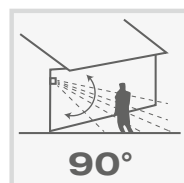



1-2



1-2

## Matteo

charcoal grey/grey/white  
high-grade steel/plastic

### 1. 96233/63

‡ 85mm ↔285mm  
→285mm ø  
TC-DSE, E27, 2 x 11W



1



### 2. 96233/22

‡ 85mm ↔285mm  
→285mm ø  
TC-DSE, E27, 2 x 11W



2







## Caspar

grey/white  
aluminium/plastic

1.96240/22 ☹

‡ 250mm ↔ 200mm

→ 110mm ø

TC-DSE, E27, 2 x 15W



4 004353 206139

1





## Tyler

black/titanium  
metal/glass

### 1. 96104/06

‡ 70mm ↔170mm  
→190mm ø  
A60, E27, 1 x 60W



1



### 2. 96104/11

‡ 70mm ↔170mm  
→190mm ø  
A60, E27, 1 x 60W



2





## Lugano

anthracite/white  
metal/plastic

1.96291/63 

↑ 192mm ↔ 181mm

→ 207mm ∅

A60, E27, 1 x 60W



1





## Gerna

high-grade steel/white  
high-grade steel/plastic

1.96196/82

↑ 380mm ↔  
→ 190mm ø 60mm  
TC-DSE, E27, 1 x 8W



1

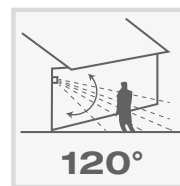

## Beas

high-grade steel/white  
high-grade steel/plastic

2.96197/82

↑ 390mm ↔  
→ 170mm ø 75mm  
TC-TSE, E27, 1 x 20W



2

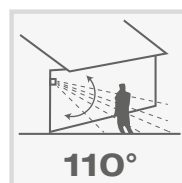



## Arto

high-grade steel  
metal/plastic

**1.96129/82** ⊕

↑ 270mm ↔ 240mm

→ 280mm ∅

A60, E27, 1 x 60W



1



**LED**  
incl.

**IP44**  



1-3

1-3

## Hanni

high-grade steel/black  
high-grade steel/glass

### 1. G96229/82

↑ 140mm ↔  
→ 120mm ø 60mm  
LED, GU10, 1 x 3W   
1 x 250 lm, 3000 K, 





1



**250**  
LUMEN

### 2. G96230/82

↑ 200mm ↔  
→ 120mm ø 60mm  
LED, GU10, 2 x 3W   
2 x 250 lm, 3000 K, 





2



**500**  
LUMEN

### 3. G96230/06

↑ 200mm ↔  
→ 120mm ø 60mm  
LED, GU10, 2 x 3W   
2 x 250 lm, 3000 K, 



3



**500**  
LUMEN



1-2



1-2



1

## Hanni

high-grade steel  
high-grade steel/glass

### 1. G96254/82

↑ 220mm ↔  
→ 100mm ø 60mm  
LED, GU10, 2 x 3W   
2 x 250 lm, 3000 K, **A++**



4 004353 220784

### 2. G96255/82

↑ 500mm ↔  
→ 125mm ø 50mm  
LED, GU10, 1 x 3W   
1 x 250 lm, 3000 K, **A++**



4 004353 220791



1

500  
LUMEN

2



250  
LUMEN



## Rune

high-grade steel/white metal/plastic

### 1. 96182/82

‡ 200mm ↔75mm  
→115mm ø  
A60, E27, 1 x 60W



### 2. 96183/82

‡ 200mm ↔75mm  
→115mm ø  
A60, E27, 1 x 60W



1



2

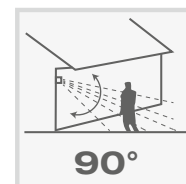





1-3

## Simone

high-grade steel/white metal/plastic

1. **96191/82** □

↑ 100mm ↔ 315mm  
→ 90mm ∅  
A60, E27, 1 x 25W



1



## Ramona

high-grade steel/white metal/plastic

2. **96192/82** □

↑ 100mm ↔ 315mm  
→ 90mm ∅  
A60, E27, 1 x 25W



2



## Celica

high-grade steel/white metal/plastic

3. **96130/82** ⊕

↑ 120mm ↔ 250mm  
→ 130mm ∅  
A60, E27, 1 x 60W



3





## Drag

white  
metal/plastic

1.96300/05 

↑ 1810mm ↔  
→ ø 350mm  
A60, E27, 1 x 60W



1





## Evergreen

white  
plastic

1. G96284/72 

↑ 280mm ↔

→ ø 154mm

LED integr., 1 x 2W 



1







AUTHENTIC

IP44  
1-2

## Arley

natural  
metal/plastic/glass

1. **96310/09** □

‡ 396mm ↔  
→ ø 290mm  
A60, E27, 1 x 60W



2. **96311/09** □

‡ 1720mm ↔  
→ ø 300mm  
A60, E27, 1 x 60W



IP44

1-2

## Arley

black/brown  
metal/plastic/glass

### 1. 96310/20

‡ 396mm ↔  
→ ø 290mm  
A60, E27, 1 x 60W



### 2. 96311/20

‡ 1720mm ↔  
→ ø 300mm  
A60, E27, 1 x 60W





1-3



3

## Reed

anthracite  
metal/plastic

### 1. 44680/63

↑ 236mm ↔ 182mm  
→ 105mm ø  
A60, E27, 1 x 40W



1



### 2. 44681/63

↑ 312mm ↔  
→ 170mm ø 133mm  
A60, E27, 1 x 60W



2



### 3. 44697/63

↑ 312mm ↔ 133mm  
→ 170mm ø  
A60, E27, 1 x 60W



3

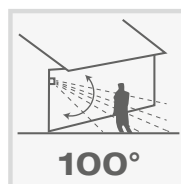



IP44  
1-3

## Reed

anthracite  
metal/plastic

### 1. 44670/63

↑ 755mm ↔  
→ ø 133mm  
A60, E27, 1 x 60W



### 2. 44685/63

↑ 500mm ↔  
→ ø 133mm  
A60, E27, 1 x 60W



### 3. 44686/63

↑ 805mm ↔  
→ ø 133mm  
A60, E27, 1 x 60W



1



3



2



IP44

1 - 2

## Gaia

black  
metal/glass

### 1. 44480/06

‡ 250mm ↔160mm  
→110mm ø  
A60, E27, 1 x 60W



1



### 2. 44482/06

‡ 355mm ↔150mm  
→225mm ø  
A60, E27, 1 x 60W



2



**AUTHENTIC**





1-3



1

## Riley

black  
metal/plastic

### 1. 42397/06

‡ 300mm ↔  
→210mm ø 205mm  
A60, E27, 1 x 40W  
♣98273/00



4 004353 228582

### 2. 42381/06

‡ 240mm ↔  
→230mm ø 210mm  
A60, E27, 1 x 40W  
♣98273/00



4 004353 228544

### 3. 42382/06

‡ 235mm ↔  
→230mm ø 210mm  
A60, E27, 1 x 40W  
♣98273/00



4 004353 228568

1

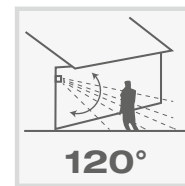

120°

2



3





1-3

## Riley

black  
metal/glass

### 1. 42370/06

↓ 780mm ↔  
→ ø 200mm  
A60, E27, 1 x 40W  
↗ 98273/00



4 004353 228605

### 2. 42384/06

↓ 425mm ↔  
→ ø 200mm  
A60, E27, 1 x 40W  
↗ 98273/00



4 004353 228629

### 3. 42385/06

↓ 1000mm ↔  
→ ø 200mm  
A60, E27, 1 x 40W  
↗ 98273/00



4 004353 229220





1-3



1

## Riley

white  
metal/glass

### 1. 42397/05

↑ 300mm ↔  
→ 210mm ø 205mm  
A60, E27, 1 x 40W  
♣98273/00



4 004353 228599

### 2. 42381/05

↑ 240mm ↔  
→ 230mm ø 210mm  
A60, E27, 1 x 40W  
♣98273/00



4 004353 228551

### 3. 42382/05

↑ 235mm ↔  
→ 230mm ø 210mm  
A60, E27, 1 x 40W  
♣98273/00



4 004353 228575

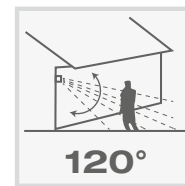

120°





1-3

## Riley

white  
metal/glass

### 1. 42370/05

↓ 780mm ↔  
→ ø 200mm  
A60, E27, 1 x 40W  
♣98273/00



1

### 2. 42384/05

↓ 425mm ↔  
→ ø 200mm  
A60, E27, 1 x 40W  
♣98273/00



2

### 3. 42385/05

↓ 1000mm ↔  
→ ø 200mm  
A60, E27, 1 x 40W  
♣98273/00



3



## Oskar

rust colour/white  
metal/plastic

### 1. 46881/55

↑ 400mm ↔  
→ 180mm ø 120mm  
TC-TSE, E27, 1 x 20W



### 2. 46897/55

↑ 400mm ↔  
→ 180mm ø 120mm  
TC-TSE, E27, 1 x 20W



### 3. 46885/55

↑ 815mm ↔  
→ ø 120mm  
TC-TSE, E27, 1 x 20W

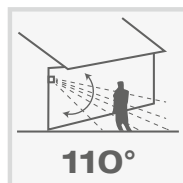



IP44 

## Oskar

rust colour/white  
metal/plastic

1.46884/55 

↑ 510mm ↔

→ ∅ 120mm

TC-TSE, E27, 1 x 20W



IP44  

1-3

## Lida

rust colour  
metal/plastic

### 1. 45880/55

↑ 245mm ↔ 245mm  
→ 120mm ∅  
A60, E27, 1 x 60W



### 2. 45884/55

↑ 470mm ↔ 150mm  
→ 150mm ∅  
A60, E27, 1 x 60W



### 3. 45885/55

↑ 900mm ↔ 150mm  
→ 150mm ∅  
A60, E27, 1 x 60W



1



3



2



IP44

1 - 2

## Whitney

rust colour/white  
metal/plastic

### 1. 46380/55

‡ 290mm ↔ 230mm  
→ 90mm ø  
A60, E27, 1 x 40W



### 2. 46394/55

‡ 590mm ↔ 150mm  
→ 150mm ø  
A60, E27, 1 x 60W



1



2



IP44  

1-2

## Lundy

anthracite  
metal/glass

1. 96292/63 

↑ 270mm ↔  
→ 155mm ø 95mm  
A60, E27, 1 x 60W



1



## Carlisle

rust colour  
metal/glass

2. 96288/55 

↑ 275mm ↔  
→ 180mm ø 100mm  
A60, E27, 1 x 60W



2



IP44

1-2

## Portland

black/rust colour  
metal/glass

### 1. 96297/06

‡ 290mm ↔240mm  
→250mm ø  
A60, E27, 1 x 60W



1



### 2. 96297/55

‡ 290mm ↔240mm  
→250mm ø  
A60, E27, 1 x 60W



2





1



1-2



1

## Nyx

anthracite  
metal/plastic

### 1. G96293/63

↑ 100mm ↔ 160mm  
→ 200mm ∅  
LED integr., 1 x 10W   
1 x 600 lm, 4200 K, 



1



600  
LUMEN

## Olena

concrete grey  
metal/glass

### 2. 96301/70

↑ ↔  
→ 110mm ∅ 285mm  
A60, E27, 1 x 60W



2





# Humphrey

anthracite  
metal/glass

1.96290/63 

↑ 182mm ↔  
→ 290mm ø 266mm  
A60, E27, 1 x 60W



IP44

1-2

## Fitzroy

rust colour  
metal/plastic

### 1. 45482/55

‡ 300mm ↔  
→180mm ø 145mm  
A60, E27, 1 x 40W



### 2. 45484/55

‡ 500mm ↔  
→ ø 145mm  
A60, E27, 1 x 40W



1



2





AUTHENTIC



IP44  

1 - 2

## Malmö

anthracite  
metal/glass

### 1. 96242/63

‡ 200mm ↔  
→365mm ø 335mm  
A60, E27, 1 x 42W



### 2. 96243/63

‡ 900mm ↔  
→ ø 335mm  
A60, E27, 1 x 42W



AUTHENTIC





1-2

## Roger

black/rust colour  
metal/glass

### 1. 41181/06

‡ 365mm ↔305mm  
→400mm ø  
A60, E27, 1 x 60W  
♣92368/00



1



### 2. 41181/55

‡ 365mm ↔305mm  
→400mm ø  
A60, E27, 1 x 60W  
♣92368/00



2



IP44

1 - 2

## Todd

rust colour/white  
metal/plastic

1. 47681/55

↑ 290mm ↔ 230mm  
→ 90mm ø  
A60, E27, 1 x 60W



1



## Jordy

black/rusty-brown  
metal/glass

2. 45582/60

↑ 290mm ↔  
→ 230mm ø 150mm  
A60, E27, 1 x 60W  
/92526/00



2





1 - 4

## Artu

black gold  
metal/glass

### 1. 46970/86

↑ 850mm ↔  
→ ø 215mm  
A60, E27, 1 x 60W  
↗92548/00



4 004353 158926

### 2. 46984/86

↑ 530mm ↔ 220mm  
→390mm ø  
A60, E27, 1 x 60W  
↗92548/00



4 004353 158940

### 3. 46985/86

↑ 985mm ↔ 220mm  
→380mm ø  
A60, E27, 1 x 60W  
↗92548/00



4 004353 158964

### 4. 46987/86

↑ 2050mm ↔ 575mm  
→ 220mm ø  
A60, E27, 2 x 60W  
↗92548/00



4 004353 158988



IP44 

## Artu

black gold  
metal/glass

1.96128/86 

↑ 260mm ↔  
→ 250mm ø 215mm  
A60, E27, 1 x 60W  
/ 92548/00



IP44

## Artu

white-gold  
metal/glass

1.96128/30

‡ 260mm ↔  
↔ 250mm ø 215mm  
A60, E27, 1 x 60W  
92548/00





IP23

1 - 2

## Irvin

white/black  
metal/glass

### 1. 96186/05

‡ 220mm ↔  
→ 160mm ø  
A60, E27, 1 x 60W



### 2. 96186/06

‡ 220mm ↔  
→ 160mm ø  
A60, E27, 1 x 60W



2





1-3



2

## Jason

black gold  
die-cast aluminium/glass

### 1. 43881/86

↑ 440mm ↔ 180mm  
→ 265mm ∅  
A60, E27, 1 x 60W  
♣ 92522/86



4 004353 128660

### 2. 43897/86

↑ 450mm ↔ 180mm  
→ 270mm ∅  
A60, E27, 1 x 60W  
♣ 92522/86



4 004353 128691

### 3. 43882/86

↑ 440mm ↔ 180mm  
→ 265mm ∅  
A60 E27 1 x 60W  
♣ 92522/86



4 004353 128677



1



2



3



90°

IP44  
  
 1-3

## Jason

black gold  
 metal/glass

### 1. 43870/86

↓ 965mm ↔  
 → ø 180mm  
 A60, E27, 1 x 60W  
 ↗ 92522/86



### 2. 43884/86

↓ 440mm ↔180mm  
 →180mm ø  
 A60, E27, 1 x 60W  
 ↗ 92522/86



### 3. 43885/86

↓ 1120mm ↔195mm  
 → 195mm ø  
 A60, E27, 1 x 60W  
 ↗ 92522/86



IP23  

1-3

## Istria

black  
 die-cast aluminium/glass

### 1. 48681/06

↑ 500mm ↔  
 → 250mm ø 160mm  
 A60, E27, 1 x 60W  
 ↗ 92198/00



### 2. 48684/06

↑ 500mm ↔  
 → ø 160mm  
 A60, E27, 1 x 60W  
 ↗ 92198/00



### 3. 48685/06

↑ 1120mm ↔  
 → ø 160mm  
 A60, E27, 1 x 60W  
 ↗ 92198/00





1-4



3

## Istria

black  
die-cast aluminium/glass

### 1. 48688/06

↑ 2350mm ↔  
→ ø 520mm  
A60, E27, 3 x 60W  
♣92198/00



4 004353 133015

### 2. 48682/06

↑ 500mm ↔  
→250mm ø 160mm  
A60, E27, 1 x 60W  
♣92198/00



4 004353 031267

### 3. 48697/06

↑ 520mm ↔  
→255mm ø 160mm  
A60, E27, 1 x 60W  
♣92198/00



4 004353 126734

### 4. 48670/06

↑ 1050mm ↔  
→ ø 180mm  
A60, E27, 1 x 60W  
♣92198/00



4 004353 133008



1



2



4



3



120°

IP23

1-3

## Istria

white  
die-cast aluminium/glass

### 1. 48681/05

‡ 500mm ↔  
→ 250mm ø 160mm  
A60, E27, 1 x 60W  
♣92198/00



### 2. 48684/05

‡ 500mm ↔  
→ ø 160mm  
A60, E27, 1 x 60W  
♣92198/00



### 3. 48685/05

‡ 1120mm ↔  
→ ø 160mm  
A60, E27, 1 x 60W  
♣92198/00





1-4



3

## Istria

white  
die-cast aluminium/glass

### 1. 48688/05

↑ 2350mm ↔  
→ ø 520mm  
A60, E27, 3 x 60W  
♣92198/00



4 004353 044847

### 2. 48682/05

↑ 500mm ↔  
→250mm ø 160mm  
A60, E27, 1 x 60W  
♣92198/00



4 004353 044748

### 3. 48697/05

↑ 520mm ↔  
→255mm ø 160mm  
A60, E27, 1 x 60W  
♣92198/00



4 004353 126727

### 4. 48670/05

↑ 1050mm ↔  
→ ø 180mm  
A60, E27, 1 x 60W  
♣92198/00



4 004353 147739

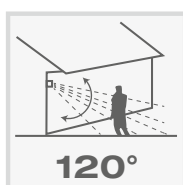

120°



1



2



3



4

IP23  

1-3

## Newport

rust colour  
 metal/glass

### 1. 44270/55

↓ 950mm ↔ 140mm  
 → ∅  
 A60, E27, 1 x 60W  
 ↗ 92539/00



### 2. 44284/55

↓ 410mm ↔  
 → ∅ 130mm  
 A60, E27, 1 x 60W  
 ↗ 92539/00



### 3. 44285/55

↓ 1020mm ↔ 140mm  
 → ∅  
 A60, E27, 1 x 60W  
 ↗ 92539/00





IP23  

1 - 4

## Newport

rust colour  
 metal/glass

### 1. 44280/55

‡ 220mm ↔ 145mm  
 → 120mm ø  
 A60, E27, 1 x 60W



4 004353 129346

1



### 2. 44281/55

‡ 340mm ↔  
 → 220mm ø  
 A60, E27, 1 x 60W  
 ↗ 92539/00



4 004353 129360

4



### 3. 44282/55

‡ 340mm ↔  
 → 220mm ø  
 A60, E27, 1 x 60W  
 ↗ 92539/00



4 004353 129384

2



### 4. 44288/55

‡ 2200mm ↔  
 → ø 500mm  
 A60, E27, 3 x 60W  
 ↗ 92539/00



4 004353 129452

3



IP23

1-3

## Newport

black  
metal/glass

### 1. 44270/06

‡ 950mm ↔ 140mm  
→ ∅  
A60, E27, 1 x 60W  
♣92539/00



### 2. 44284/06

‡ 410mm ↔  
→ ∅ 130mm  
A60, E27, 1 x 60W  
♣92539/00



### 3. 44285/06

‡ 1020mm ↔ 140mm  
→ ∅  
A60, E27, 1 x 60W  
♣92539/00



2



3



IP23

1-3

## Newport

black  
metal/glass

### 1. 44280/06

↑ 220mm ↔ 145mm  
→ 120mm ∅  
A60, E27, 1 x 60W



4 004353 129339

1



### 2. 44281/06

↑ 340mm ↔  
→ 220mm ∅  
A60, E27, 1 x 60W  
/92539/00



4 004353 057861

2



### 3. 44282/06

↑ 340mm ↔  
→ 220mm ∅  
A60, E27, 1 x 60W  
/92539/00



4 004353 057878

3



### 4. 44288/06

↑ 2200mm ↔  
→ ∅ 500mm  
A60, E27, 3 x 60W  
/92539/00



4 004353 129445

4



IP23

1-3

## Newport

white  
metal/glass

### 1. 44270/05

↑ 950mm ↔ 140mm  
→ ∅  
A60, E27, 1 x 60W  
↗ 92539/00



### 2. 44284/05

↑ 410mm ↔  
→ ∅ 130mm  
A60, E27, 1 x 60W  
↗ 92539/00



### 3. 44285/05

↑ 1020mm ↔ 140mm  
→ ∅  
A60, E27, 1 x 60W  
↗ 92539/00

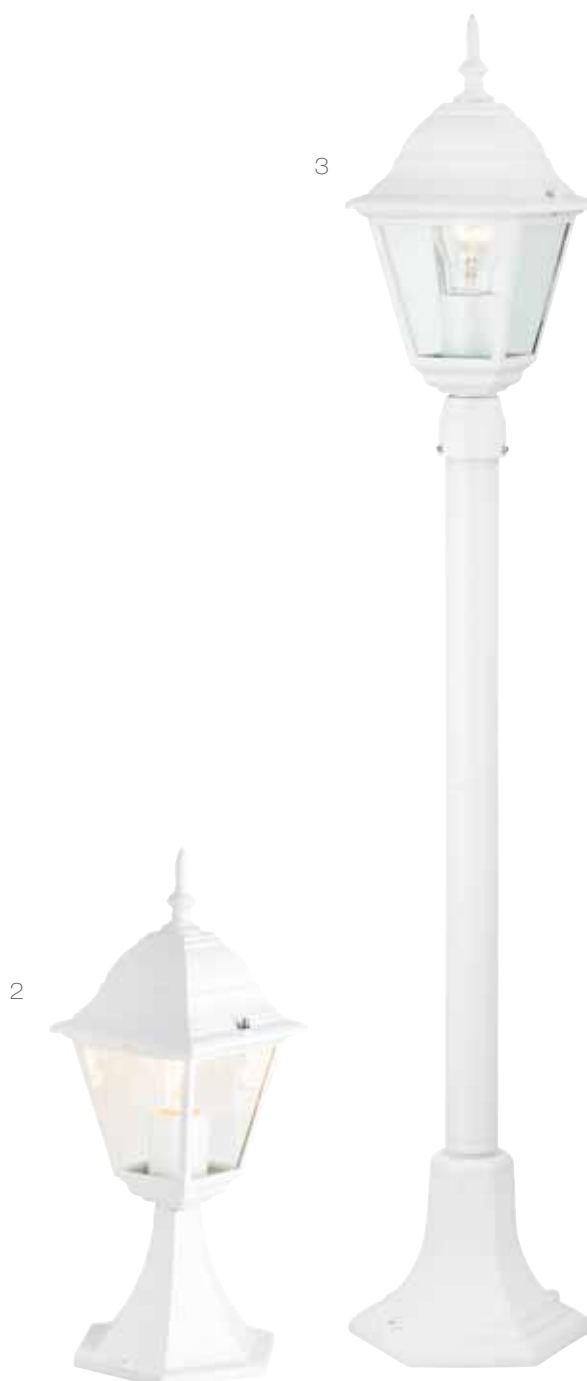
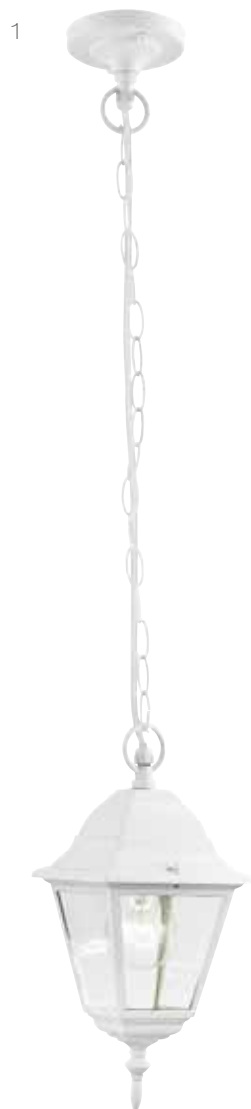

IP23  

1-3

## Newport

white  
 metal/glass

### 1. 44280/05

↑ 220mm ↔ 145mm  
 → 120mm ∅  
 A60, E27, 1 x 60W



1



### 2. 44281/05

↑ 340mm ↔  
 → 220mm ∅  
 A60, E27, 1 x 60W  
 ↗ 92539/00



2



### 3. 44282/05

↑ 340mm ↔  
 → 220mm ∅  
 A60, E27, 1 x 60W  
 ↗ 92539/00



3





1-3



2

## Crown

black  
die-cast aluminium/glass

### 1. 40281/06

‡ 310mm ↔165mm  
→220mm ø  
A60, E27, 1 x 60W



1

### 2. 40297/06

‡ 355mm ↔190mm  
→235mm ø  
A60, E27, 1 x 60W



2

### 3. 40282/06

‡ 310mm ↔165mm  
→220mm ø  
A60, E27, 1 x 60W



3

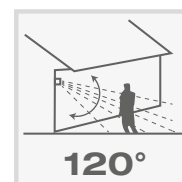

IP44  

1-3

## Crown

black  
 die-cast aluminium/glass

### 1. 40284/06

‡ 370mm ↔  
 → ø 165mm  
 A60, E27, 1 x 60W



### 2. 40285/06

‡ 1000mm ↔  
 → ø 240mm  
 A60, E27, 1 x 60W



### 3. 40288/06

‡ 2000mm ↔  
 → ø 520mm  
 A60, E27, 3 x 60W



1



2



3





1-5

## Crown

white  
die-cast aluminium/glass

### 1. 40281/05

↑ 310mm ↔ 165mm  
→ 220mm ∅  
A60, E27, 1 x 60W



### 2. 40297/05

↑ 355mm ↔ 190mm  
→ 235mm ∅  
A60, E27, 1 x 60W



### 3. 40282/05

↑ 310mm ↔ 165mm  
→ 220mm ∅  
A60, E27, 1 x 60W



### 4. 40284/05

↑ 370mm ↔  
→ ∅ 165mm  
A60, E27, 1 x 60W



### 5. 40285/05

↑ 1000mm ↔  
→ ∅ 240mm  
A60, E27, 1 x 60W

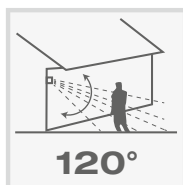



AUTHENTIC

  
Brilliant





# FUNCTION





1-3



1-3

## Perth

black/white  
metal/plastic

### 1. G96294/06

↑ 85mm ↔  
→ ø 190mm  
LED integr., 1 x 8W   
1 x 520 lm, 4000 K, **A**



520  
LUMEN

### 2. G96295/06

↑ 80mm ↔  
→ ø 240mm  
LED integr., 1 x 13,5W   
1 x 965 lm, 4000 K, **A**



2



965  
LUMEN

### 3. G96296/06

↑ 80mm ↔  
→ ø 305mm  
LED integr., 1 x 17,8W   
1 x 1305 lm, 4000 K, **A**



3



1305  
LUMEN

**FUNCTION**



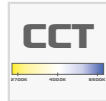

## Medway

white/anthracite  
plastic

### 1. G96309/05

↑ 90mm ↔  
→ ø 300mm  
LED integr., 1 x 18W   
1 x 1320 lm, 3000-6000 K, **A**



1



1320  
LUMEN

### 2. G96309/63

↑ 90mm ↔  
→ ø 300mm  
LED integr., 1 x 18W   
1 x 1320 lm, 3000-6000 K, **A**



2



1320  
LUMEN





1-2



1-2

## Medway

white/anthracite  
plastic

### 1. G96053/05

↑ 90mm ↔  
→ ø 310mm  
LED integr., 1 x 12W   
1 x 1000 lm, 4000 K, **A**



1



1000  
LUMEN

### 2. G96053/63

↑ 90mm ↔  
→ ø 310mm  
LED integr., 1 x 12W   
1 x 1000 lm, 4000 K, **A**



2



1000  
LUMEN

**LED**  
incl.

1-2

**IP65**  

1-2

## Ballina

white/anthracite  
plastic

### 1. G96307/05

↑ ↓  
→100mm ø 300mm  
LED integr., 1 x 12W   
1 x 805 lm, 4200 K, 



4 004353 259753

### 2. G96307/63

↑ ↓  
→100mm ø 300mm  
LED integr., 1 x 12W   
1 x 805 lm, 4200 K, 



4 004353 259746

1



**805**  
LUMEN

2



**805**  
LUMEN





## Ballina

white/anthracite  
plastic

### 1. G96308/05

↑ ↓  
→ ←  
→100mm ø 300mm  
LED integr., 1 x 12W  
1 x 805 lm, 4200 K, **A**



### 2. G96308/63

↑ ↓  
→ ←  
→100mm ø 300mm  
LED integr., 1 x 12W  
1 x 805 lm, 4200 K, **A**



1



805  
LUMEN

2



805  
LUMEN



1-2



1-2

## Tilbury

white/anthracite  
plastic

### 1. G96054/05

‡ 172mm ↔ 115mm  
→ 80mm ø  
LED integr., 1 x 5W   
1 x 450 lm, 4200 K, **A+**



### 2. G96054/63

‡ 172mm ↔ 115mm  
→ 80mm ø  
LED integr., 1 x 5W   
1 x 450 lm, 4200 K, **A+**



1



450  
LUMEN

2



450  
LUMEN

# FUNCTION

  
Brilliant





## Skipper

black/titanium  
die-cast aluminium/glass

### 1. 48480/06

↑ ↓  
→ 70mm ø 270mm  
TC-DSE, E27, 1 x 11W



### 2. 48480/11

↑ ↓  
→ 70mm ø 270mm  
TC-DSE, E27, 1 x 11W



## Maritim

black/titanium  
die-cast aluminium/glass

### 3. 53680/06

↑ ↓  
→ 110mm ø 265mm  
A60, E27, 1 x 60W



### 4. 53680/11

↑ ↓  
→ 110mm ø 265mm  
A60, E27, 1 x 60W





1-5

## Artos

black/titanium  
die-cast aluminium/glass

### 1. 48581/06

↑ 195mm ↔ 310mm  
→ 110mm ∅  
A60, E27, 1 x 60W



1



### 2. 48581/11

↑ 195mm ↔ 310mm  
→ 110mm ∅  
A60, E27, 1 x 60W



2



## Elton

white/black  
plastic/glass

### 3. 96184/05

↑ 195mm ↔ 125mm  
→ 105mm ∅  
A60, E27, 1 x 60W



3



### 4. 96184/06

↑ 195mm ↔ 125mm  
→ 105mm ∅  
A60, E27, 1 x 60W



4



5



## Jerry

titanium  
metal/glass

### 5. 96105/11

↑  
→ 95mm ↔ 180mm  
∅  
A60, E27, 1 x 60W





1 - 4

## Silvester

white/black  
metal/glass

### 1. 96106/05

↓      ↔  
→ 90mm    ø 180mm  
A60, E27, 1 x 60W



1



### 2. 96106/06

↓      ↔  
→ 90mm    ø 180mm  
A60, E27, 1 x 60W



2



## Tweety

white/black  
metal/glass

### 3. 96107/05

↓      ↔  
→ 100mm    ø 180mm  
A60, E27, 1 x 60W



3



### 4. 96107/06

↓      ↔  
→ 100mm    ø 180mm  
A60, E27, 1 x 60W



4





1-2



3

## Philipp

high-grade steel  
metal/glass

1. 96108/82 ⊕

↓      ↔  
→100mm    ø 190mm  
A60, E27, 1 x 60W



1



2. 96109/82 ⊕

↓      ↔  
→100mm    ø 190mm  
A60, E27, 1 x 60W



2



## Nevada

high-grade steel  
metal/glass

3. 41380/82 ⊕

↓      ↔  
→90mm    ø 270mm  
A60, E27, 1 x 60W



3



Incl.

**3x 0-9**  
**1 x a-h**



1 - 4

## Tanko

grey  
metal/glass

### 1. 96161/22

‡ 120mm ↔ 140mm  
→ 170mm ø  
QT-DE12, R7s, 1 x 150W



### 2. 96163/22

‡ 250mm ↔ 180mm  
→ 230mm ø  
QT-DE12, R7s, 1 x 400W



## Sensor

white/black  
plastic

### 3. 96193/05

‡ 80mm ↔ 85mm  
→ 100mm ø



### 4. 96193/06

‡ 80mm ↔ 85mm  
→ 100mm ø

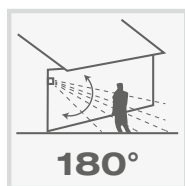





1 - 4



2, 4

## Tanko

white  
metal/glass

### 1. 96161/05

‡ 120mm ↔140mm  
→170mm ø  
QT-DE12, R7s, 1 x 150W



1



### 2. 96162/05

‡ 220mm ↔140mm  
→210mm ø  
QT-DE12, R7s, 1 x 150W



2



### 3. 96163/05

‡ 250mm ↔180mm  
→230mm ø  
QT-DE12, R7s, 1 x 400W



3



### 4. 96164/05

‡ 250mm ↔180mm  
→230mm ø  
QT-DE12, R7s, 1 x 400W



4

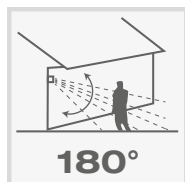



1-5



2-3

## Tanko

black  
metal/glass

### 1. 96161/06

‡ 120mm ↔140mm  
→170mm ø  
QT-DE12, R7s, 1 x 150W



### 2. 96162/06

‡ 220mm ↔140mm  
→210mm ø  
QT-DE12, R7s, 1 x 150W



### 3. 96164/06

‡ 250mm ↔180mm  
→230mm ø  
QT-DE12, R7s, 1 x 400W



### 4. 96159/06

‡ 335mm ↔140mm  
→170mm ø  
QT-DE12, R7s, 1 x 150W



### 5. 96160/06

‡ 420mm ↔180mm  
→230mm ø  
QT-DE12, R7s, 1 x 400W

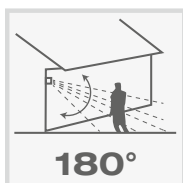



## Tanko

black  
metal/glass

1.96163/06 

‡ 250mm ↔ 180mm

→ 230mm ø

QT-DE12, R7s, 1 x 400W



4 004353 260094





1-3



1-3



1-3

## Tibor

black  
plastic

### 1. G96231/06

↑ 460mm ↔  
→ 160mm ∅  
LED, E27, 1 x 12W   
1 x 800 lm, 3000 K, **A**



4 004353 189869



800  
LUMEN

## Janko

black/grey  
aluminium/glass

### 2. G96232/06

↑ 320mm ↔  
→ 150mm ∅  
LED, GU10, 1 x 3W   
1 x 250 lm, 3000 K, **A++**



4 004353 189852



250  
LUMEN

### 3. G96232/22

↑ 320mm ↔  
→ 150mm ∅  
LED, GU10, 1 x 3W   
1 x 250 lm, 3000 K, **A++**



4 004353 264818



250  
LUMEN



1



2-3

## Brick

high-grade steel  
metal/plastic/glass

### 1. 96172/82

↑ 236mm ↔ 112mm  
→ 93mm ø  
A60, E27, 1 x 40W



1



## Derby

high-grade steel  
high-grade steel/plastic

### 2. G96268/82

↑ 125mm ↔  
→ ø 100mm  
LED integr., 1 x 3W  
1 x 200 lm, 4000 K, A+



## Carlton

high-grade steel  
high-grade steel/plastic

### 3. G96269/82

↑ 120mm ↔  
→ ø 150mm  
LED integr., 1 x 10W  
1 x 650 lm, 4000 K, A+



2

200  
LUMEN



3

650  
LUMEN



**LED**  
incl.

2 - 5

**IP44**

1

**IP65**

2 - 5

## Darius

black/warm white/cool white  
plastic

### 1. 53524A05

power supply  
‡ ↔1500mm  
→ ∅



### 2. G53500A05

‡ ↔1000mm  
→ ∅  
LED integr., 5W/m   
160lm/m, 3000K



**160**  
LUMEN

### 3. G53500A75

‡ ↔1000mm  
→ ∅  
LED integr., 5W/m   
180lm/m, 6000K



**180**  
LUMEN

### 4. G53501A05

‡ ↔5000mm  
→ ∅  
LED integr., 5W/m   
160lm/m, 3000K



**160**  
LUMEN

### 5. G53501A75

‡ ↔5000mm  
→ ∅  
LED integr., 5W/m   
180lm/m, 6000K



**180**  
LUMEN

FUNCTION

  
Brilliant



# LED lightstrip

## CHANGES COLOR IN TIME WITH THE MUSIC

- 🎵 8 colors and 8 different programs
- 🎵 4 programs can „listen“ and flash in time with the music
- 🎵 IP65 strip
- 🎵 Remote control incl.
- 🎵 Easy to use self-adhesive lightstrip
- 🎵 Adjustable length:  
can be cut every 10cm

## Light Strip Music

transparent/multi-coloured  
metal/plastic

1. **G94432A72** 

↑ ↔ 5000mm

→ ∅

LED integr., 5 x 5,5W 



4 004353 238963

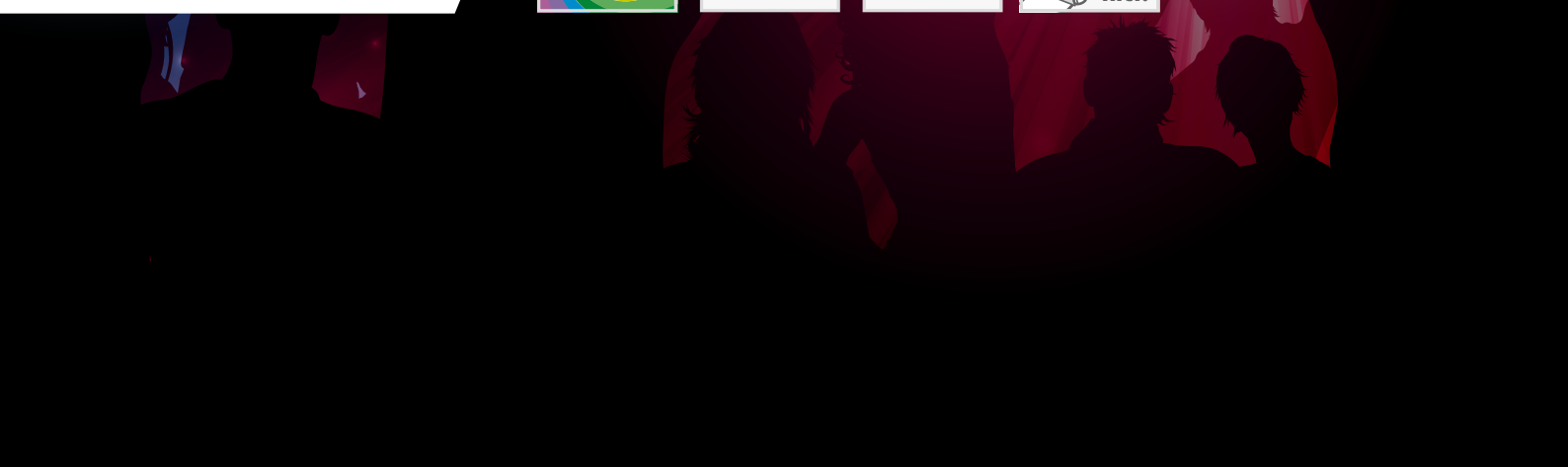



FUNCTION



# interface

LICHT SYSTEM

## Das Prinzip: Erstellen Sie Ihre persönliche Leuchte

Mit **interface** erstellen Sie ganz einfach Ihre persönliche Außenleuchte

## Principle: customize your outdoor wall light

The **interface** concept allows to personalize your outdoor wall light in a simple fashion



- ▶ Bauen Sie ganz leicht Ihre eigene Leuchte
- ▶ Leicht zu installieren
- ▶ Wählen Sie aus einer Vielzahl von Designs
- ▶ Wartungsfrei

**Lassen Sie Ihrer Fantasie freien Lauf, um Ihr persönliches Licht zu schaffen!**

- ▶ Personalize your light
- ▶ Easy to install
- ▶ Choose from a wide range of designs
- ▶ Maintenance free

**Let your imagination run wild to create a unique light!**



## Principe: créez votre applique extérieure personnalisée

Le concept **interf**ace permet de personnaliser votre applique extérieure en toute simplicité

## Principio: personalizza la tua applique da esterni

**interf**ace ti aiuta a personalizzare la tua applique da esterni in tutta semplicità



Choisissez votre diffuseur  
Scegli il diffusore

Assemblez avec votre décor  
Assembla con il decoro che preferisci

Terminé!  
Fatto!

- ▶ Personnalisez votre luminaire
- ▶ Facile à installer
- ▶ Choisissez parmi de nombreux décors et finitions
- ▶ Sans entretien

**laissez courir votre imagination pour créer un luminaire unique !**

- ▶ Personalizzazione dell'illuminazione
- ▶ Facilità di installazione
- ▶ Ampia gamma di decori e finiture
- ▶ Senza manutenzione

**Lascia correre la fantasia e crea la luce a tuo piacimento!**

## Version 1: horizontal model

1



Basis wählen / Select your diffuser  
 Choisissez votre diffuseur / Scegli il diffusore

2



Abdeckung aufstecken / Assemble with your cover  
 Assemblez avec votre décor / Assembla con il decoro che preferisci



=



Fertig! / Completed!  
 Terminé! / Fatto!



## Interface

white  
plastic

1.96260/05 

‡ 100mm ↔ 310mm

→ 90mm ø

A60, E27, 1 x 25W



1



## Interface

anthracite/high-grade steel  
metal

### 1. 98372/63

‡ 100mm ↔ 370mm



1



### 2. 98372/82

‡ 100mm ↔ 370mm



2



### 3. 98379/82

‡ 100mm ↔ 370mm



3



### 4. 98379/63

‡ 100mm ↔ 370mm



4



## Interface

anthracite/high-grade steel/white/rust colour  
metal

### 1. 98190/63

‡ 100mm ↔ 370mm



1



### 2. 98190/82

‡ 100mm ↔ 370mm



2



### 3. 98193/05

‡ 100mm ↔ 370mm



3



### 4. 98193/55

‡ 100mm ↔ 370mm



4



## Interface

anthracite/high-grade steel  
metal

### 1. 98194/63

↑ 100mm ↔ 370mm



### 2. 98194/82

↑ 100mm ↔ 370mm





INTERFACE



## Version 2: vertical model

1



Basis wählen / Select your diffuser  
 Choisissez votre diffuseur  
 Scegli il diffusore



2



Abdeckung aufstecken  
 Assemble with your cover  
 Assemblez avec votre décor  
 Assembla con il decoro che preferisci



Fertig! / Completed!  
 Terminé! / Fatto!



## Interface

white  
plastic

**1.96261/05** 

‡ 250mm ↔ 160mm

→ 90mm ø

A60, E27, 1 x 40W



1



## Interface

anthracite/high-grade steel  
metal

### 1. 98197/63

↑ 290mm ↔ 200mm



### 2. 98197/82

↑ 290mm ↔ 200mm



### 3. 98198/63

↑ 290mm ↔ 200mm



### 4. 98198/82

↑ 290mm ↔ 200mm



1



2



3



4



## Interface

white/rust colour/anthracite/high-grade steel metal

### 1. 98200/05

↑ 290mm ↔ 200mm



### 2. 98200/55

↑ 290mm ↔ 200mm



### 3. 98371/63

↑ 290mm ↔ 200mm



### 4. 98371/82

↑ 290mm ↔ 200mm



1



2



3

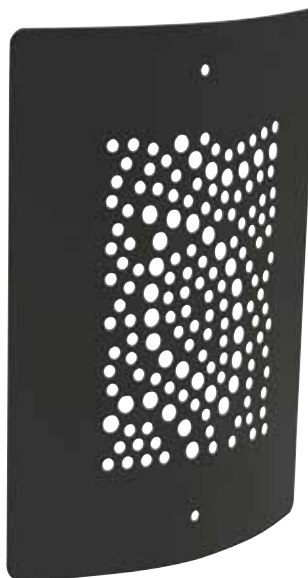

4



## Interface

white/anthracite  
metal

### 1. 98380/05

↑ 290mm ↔ 200mm



1



### 2. 98380/63

↑ 290mm ↔ 200mm



2

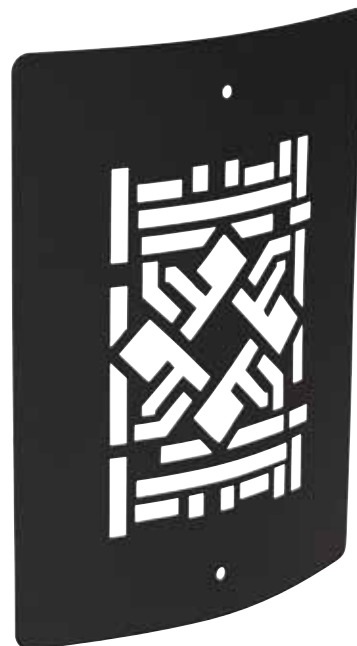

# INTERFACE





## HELLIGKEIT LEICHT ÜBER DEN LICHTSCHALTER STEUERN

- Patentierte Lichttechnik
- Stufenlos dimmbar für ein individuelles Lichtambiente
- Kein extra Dimmer-Schalter benötigt
- Dimmt langsam auf ca. 10% Leuchtkraft herunter



Erfahren sie mehr über unsere  
LED Innovationen unter:

**[www.brilliant-ag.de](http://www.brilliant-ag.de)**





E14  
Candle

E14  
Reflector

E27 G95  
Globe

E14 R50  
Miniglobe

E27 A60  
Ambience

GU10 SMD  
Reflector

**DIMMABLE WITH  
EVERY CONVENTIONAL  
LIGHT SWITCH**

**TRANSFORME TOUS  
LES INTERRUPTEURS  
HABITUELS EN  
VARIATEURS DE LUMIERE**

**DIMMERABILE  
CON QUALSIASI  
INTERRUPTORE DELLA  
LUCHE TRADIZIONALE**



## **EASY DIMMING WITH YOUR CONVENTIONAL LIGHTSWITCH**

- ▶ patented lighting technology
- ▶ infinitely dimmable for an individual lighting ambience
- ▶ no extra dim switch required
- ▶ dims down to about 10% luminosity



## **RÉGLER LA LUMINOSITÉ FACILEMENT AVEC L'INTERRUPTEUR**

- ▶ Technique d'éclairage brevetée
- ▶ La lumière se tamise en douceur pour un éclairage personnalisé
- ▶ Pas besoin d'installer de variateur de lumière
- ▶ L'intensité de l'éclairage se tamise lentement jusqu'à 10%



## **REGOLARE FACILMENTE LA LUMINOSITÀ MEDIANTE L'INTERRUPTORE DELLA LUCE**

- ▶ Tecnica d'illuminazione brevettata
- ▶ Dimmerabile in maniera continua per un ambiente luminoso personalizzato
- ▶ Non è necessario un ulteriore interruttore dimmer
- ▶ Lenta diminuzione dell'intensità luminosa a ca. 10%

**SEHEN SIE SICH DAS VIDEO AN / WATCH THE VIDEO HERE  
REGARDEZ LA VIDÉO / GUARDATE IL VIDEO**

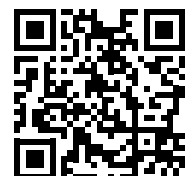





# TECHNICAL DETAILS



Erklärungen · Guidance · Verklaringen · Explications · Explicación  
Explicações · Vysvetlivky · Objasńenia · Spiegazioni

<b>NAME</b>	<b>Aalborg LED</b>	<b>SAFETY CLASS</b>
<b>COLOUR</b>	• high-grade steel/white	<b>WIDTH</b>
<b>MATERIAL</b>	• high-grade steel/glass	<b>DIAMETER</b>
<b>ART.-NR.</b>	<b>1. G44081/82</b>	<b>BULB INCL.</b> <input checked="" type="checkbox"/>
<b>1. G44081 / 82</b>	• $\uparrow$ 320mm $\leftrightarrow$	<b>LUMEN, KELVIN, EEC CLASS</b>
<b>IMAGE ART.-NR. COLOUR</b>	• $\rightarrow$ 220mm $\emptyset$	<b>SPARE PARTS</b>
<b>HEIGHT</b>	LED, E27, 1 x 5,8W <input checked="" type="checkbox"/>	
<b>THROUT DEPTH</b>	1 x 630 lm, 2700 K, <b>A++</b>	
	• 92216/92	
		
	4 004353 230479	

## CE

Alle unsere Leuchten werden nach den Richtlinien der EN 60598 gefertigt. · All our light fittings are manufactured in compliance with the guidelines of EN 60598. · Alle onze lampen worden volgens de richtlijnen EN 60598 vervaardigd. · Toutes nos lampes sont fabriquées en conformité avec les directives EN 60598. · Todas nuestras lámparas se fabrican según la norma EN 60598. · Todas as lâmpadas são produzidas de acordo com a norma EN 60598. · Všechna svítidla jsou vyráběna podle směrnic evropské normy EN 60598. · Wszystkie lampy produkowane są zgodnie z wytycznymi normy EN 60598. · O tutte le nostre lampade sono costruite secondo le direttive EN 60598.

## IP 21

Tropfwassergeschützt · protection against drops of condensed water · druijswaterdicht · protection contre l'eau · protegido contra la condensación de agua · protecção contra humidade e gotas de água · odolné proti vodě · ochrona przed kroplami wody · protezione contro la condensa d'acqua

## IP 44

Spritzwassergeschützt · splashproof · spatwaterdicht · protection contre les projections d'eau · protegida contra salpicaduras de água · protegido contra pingos de água · chráněné proti ostrůku vodou · ochrona przed strumieniem wody · protetto contro l'acqua a spruzzo

## IP 65

Staubdicht und strahlwassergeschützt · dust-tight and protected against water jets · stofdicht en straalwaterdicht · étanche à la poussière et protégé contre les jets d'eau · a prueba de polvo y chorros de agua · à prova de pó e jatos de água · prachotěsné a chráněné proti proudění vody · ochrona przed pyłem i strumieniem wody · protetto contro la polvere e contro gli spruzzi d'acqua



Schutzklasse I: Diese Leuchte hat einen Schutzleiteranschluss · Protection class I: This lamp has an earth terminal · Beschermlasse I: Deze lamp heeft een veiligheidsaarddraadaansluiting · Catégorie de protection I: Cette lampe possède une prise de terre · Clase de protección I: Este foco dispone de un conector para el cable de protección · Classe de protecção I: Este candeeiro tem em fio de segurança · Trída ochrany I: Toto svítidlo je vybaveno zapojením s ochranným vodičem · Klasa ochronna I: Lampa ta posiada uziemienie · Classe di protezione I: Questa lampada è dotata di morsetto per il collegamento alla messa a terra di protezione.



Schutzklasse II: Diese Leuchte ist doppelt isoliert und darf nicht an einen Schutzleiter angeschlossen werden · Protection class II: This lamp is doubly insulated and must not be connected to an earth wire · Beschermlasse II: Deze lamp is dubbel geïsoleerd en mag niet op een veiligheidsaarddraad worden aangesloten · Catégorie de protection II: Cette lampe est doublement isolée et ne doit pas être branchée sur la terre ·

Clase de protección II: Este foco tiene doble aislamiento y no se debe conectar a un cable de protección · Classe de protecção II: Este candeeiro tem uma isolação dupla e não pode ser ligado ao contacto de segurança · Trída ochrany II: Toto svítidlo je dvojnásobně izolováno a nesmí být připojeno na ochranný vodič; Klasa Ochronna II: Lampa ta posiada podwójną izolację i nie może być podłączona do uziemienia · Classe di protezione II: Questa lampada è dotata di doppio isolamento e non deve essere collegata alla messa a terra di protezione





















Schutzklasse III: Diese Leuchte darf nur an Schutzkleinspannung bis max. 42 Volt angeschlossen werden · Protection class III: Lamps may only be connected to a safety extra-low voltage with a maximum of 42 V · Beschermlasse III: Lamp mag alleen op veiligheidskleinspanning tot max. 42 volt aangesloten worden · Catégorie de protection III: Cet éclairage doit seulement être raccordé à basses tensions de protection allant jusqu'à 42 Volts · Clase de protección III: La lámpara sólo se puede conectar a una tensión de protección de hasta 42 voltos como máximo · Classe de protecção III: O projector spenas deverá ser conectado a corrente eléctrica de baixa tensão de no máx. 42 Volts · Trída ochrany III: Svítidlo se smí napojovat pouze na ochranné malé napětí do max. 42 V · Klasa Ochronna III: Lampę wolno podłączać jedynie do sieci o niskim napięciu max. 42 Volt · Classe di protezione III: Questa lampada deve essere collegata solo a bassissima tensione di sicurezza.

# TECHNICAL DETAILS



## Erklärungen · Guidance · Verklaringen · Explications · Explicación · Explicações · Vysvetlivky · Objasńnienia · Spiegazioni

 <p>LED inkl. · LED incl. · LED inclusief · LED inclus · LED incluido · LED incluíd · LED vrátane · w tym LED · LED inclusi</p>	 <p>Farbwechsel · Colour changing · Kleurvariatie · Changement de couleur · Cambio de color · mudança de cor · změna barvy · zmiana koloru · cangiante</p>	 <p>Lichtfarbe einstellbar · Adjustable light colour · Lichtkleur instelbaar · Couleur de lumière réglable · Color de la luz ajustable · Cor da luz ajustável · Nastavitelná barva · regulowany kolor światła · Colore della luce regolabile</p>	 <p>Eine Fernbedienung für bis zu 4 Leuchten · One remote control for up to four lamps · Eén afstandsbediening voor maximaal vier lampen · Une télécommande pour jusqu'à 4 luminaires · Control remoto para hasta cuatro luces · um telecomando para até quatro lâmpadas · dálkový ovladač až pro čtyři světla · pilot do obsługi aż czterech lamp · Un comando remoto per un massimo di 4 luci</p>
  <p>Fernbedienung · remote control · Afstandsbediening · télécommande · Mando a distancia · control remoto · dálkové ovládání · pilot · telecomando</p>	 <p>App Steuerung · App control · App-besturing · Commande par application · Control por App · Comando da aplicação · Řízení pomocí aplikace · sterowanie APP · Comando App</p>	 <p>Bluetooth Steuerung · Bluetooth control · Bluetooth-besturing · Commande par Bluetooth · Control por Bluetooth · Comando da Bluetooth · Řízení pomocí Bluetooth · sterowanie Bluetooth · Comando Bluetooth</p>	 <p>Lichtauslass oben und unten · Light outlet at the top and at the bottom · Lichtuitlaat boven- en onderaan · Sortie de lumière en haut et en bas · Emisión de luz superior e inferior · Saída de luz em cima e em baixo · Výstup světla nahore a dole · wylot światła z góry i z dołu · Illuminazione sopra e sotto</p>
 <p>Flexgelenk · flex joint · flexibel · articulation flex · articulación flexible · articulação flexível · ohebný kloub · przgbg flex · giunto flex</p> <p>Drehbar · revolving · draaibaar · orientable · giratorio · girável · otočné · obrotowe · girevole</p>	 <p>mit Bewegungsmelder · with motion detector · met bewegingsmelder · avec détecteur de mouvements · con detector de movimiento · com detector de movimento · hlasicem pohybu · ze zintegrowanym czujnikiem · con rivelatore di movimento</p>	 <p>Schaltet ein bei Dunkelheit · Turns on in darkness · Wordt ingeschakeld in de duisternis · Active dans l'obscurité · Se enciende en la oscuridad · Ativa na escuridão · Zapne ve tmě · Włącza się w ciemności · Si accende nel buio · Включает в темноте</p>	 <p>Steckdose enthalten · powerpoint included · Contactdoos inbegrepen · prise incluse · incluye enchufe · tomada incluida · obsahuje zásuvku · zawiera gniazdo wtykowe · presa inclusa</p>
 <p>2 Leuchtmittel benötigt · 2 bulbs required · 2 lampen vereist · 2 ampoules nécessaires · se necesitan 2 bombillas · 2 lâmpadas necessárias · jsou potřeba 2 žárovky · wymagane 2 żarówki · 2 lampadine necessarie · Требуются 2 источника света</p>	 <p>IP 23 · regengeschützt · rainproof · regenwaterdicht · impermeable à la pluie · a prueba de lluvia · protegido contra chuva · chránené proti dešti · hermetyczna · protetto contro la pioggia</p>	 <p>IP 44 · Spritzwassergeschützt · splashproof · spatwaterdicht · protection contre les projections d'eau · protegida contra salpicaduras de agua · protegido contra pingos de água · chráněné proti ostríku vodou · ochrona przed strumieniem wody · protetto contro l'acqua a spruzzo</p>	 <p>IP 54 · Spritzwassergeschützt · splashproof · spatwaterdicht · protection contre les projections d'eau · protegida contra salpicaduras de agua · protegido contra pingos de água · chráněné proti ostríku vodou · ochrona przed strumieniem wody · protetto contro l'acqua a spruzzo</p>
 <p>IP 65 · Staubdicht und strahlwassergeschützt · dust-tight and protected against water jets · stofdicht en beschermd tegen water jets · étanche à la poussière et protégé contre les jets d'eau · a prueba de polvo y chorros de agua · à prova de pó e jatos de água · prachotě sně a chráněné proti proudu m vody · ochrona przed pyłem i strumieniem wody · protetto contro la polvere e contro gli spruzzi d'acqua</p>	 <p>IP 67 · Staubdicht und Schutz gegen Wassereindringung bei zeitweisem Eintauchen · Dust tight and protection against Water penetration during temporary immersion · Stofdicht en bescherming tegen indringen van water bij tijdelijk onderdompelen · Hermétiques à la poussière et protection contre les infiltrations d'eau pendant une immersion temporaire · Resistencia al polvo y protección contra la penetración de agua durante la inmersión temporal · Estantiquidade ao pó e protecção contra a penetração de água durante, a imersão temporária · Odolność proti prachu a ochrana proti vniknutí vody při krátkodobém ponoření · Pyłoszczelne i zabezpieczone przed dostaniem się wody w przypadku chwilowego zanurzenia · A prova di polvere e d'infiltrazione d'acqua durante un'immersione temporanea · Пыленепроницаемый и защищенный от проникновения воды при непродолжительном погружении</p>		

# TERMS / INDEX



## Section 1 General Scope / Offers

1. Our sales and delivery terms shall be exclusively applicable; terms to the contrary or terms deviating from those of the purchaser will not be recognized by us, unless we have expressly agreed to their validity in writing. Our sales and delivery terms shall also be applicable if aware of terms to the contrary or terms deviating from purchaser's terms we will without any proviso carry out the delivery to the purchaser. An assignment ban in the Buyer's conditions is expressly refuted.
2. Any agreements entered into between us and the purchaser with the intention of implementing the contract, will have to be defined in writing.
3. Our purchasing and delivery terms shall also be applicable to all future transactions with the purchaser.
4. Our offers are net and free. Contracts will be entered into upon receipt of our written order confirmation, latest when the goods have been delivered. We can accept orders within four weeks.

## Section II Prices, Freight Charges/ Payment Terms

1. Prices are net plus German value added tax (V.A.T.) and freight charges ex works or ex warehouse, unless anything else has been expressly specified in writing.

For orders exceeding a net goods value of Euro 750.-, Brilliant will not charge any freight expenses. In case of a net goods value of Euro 750.- or less, Brilliant will charge a global freight rate of 7% of the goods net value for domestic deliveries, however at least Euro 12.50.

2. Payment of the purchase price shall take place within the agreed term, within ten days after receipt of invoice net, unless agreed differently.
3. Bills (promissory notes), and checks will be accepted by us only upon prior agreement and provided they can be taken on discount. All discount fees shall be debited to the customer and have to remunerated to us at once. Bill or check amounts will be credited only upon definite receipt of the equivalent amount.
4. If payments are overdue, we shall be entitled to charge 8% interest for delay above the respective to as set out in § 247 of the German Civil Code. If we are able to claim a higher delay damage, we shall be entitled to assert it. Purchasers on the other hand shall be entitled to provide evidence that due to such payment delays we have either not been suffering any damage or to a much lesser extent.
5. If the purchaser will not pay its money when due or if a serious deterioration in its financial position has been incurred, we shall be entitled to make payable the entire remaining amount due, even though we already have accepted bills or checks from the purchaser. In such particular circumstances we shall be entitled to ask for prepayments or securities and to refuse fulfillment of our obligations until we have received such prepayments or securities.

If such requests will not have been fulfilled within the suitable period specified by us, we shall be justified to withdraw from the contract and/or to claim damages because of non-performance. In case of cessation of payments or over-indebtedness, an additional period of time will not be granted.

6. We shall be entitled to set off all purchaser's outstanding accounts payable to us against our outstanding accounts payable to purchaser. The purchaser's setting off rights will be acceptable only if its counterclaims have been asserted to be legal, undisputed, and approved by us. For any disputed counterclaims, purchaser shall be not able to assert any right of retention.
7. In the case of a delay with more than one liability, the complete claim against the Buyer is immediately due for payment.
8. Our claims have been relinquished in favour of the Deutsche Factoring Bank, Bremen.

## Section III. Reservation of Proprietary Rights

1. All produce supplied shall remain our sole property until all outstanding accounts payable to us which we are entitled to against the purchaser for any legal reason have been paid.

If for exceptional reasons the purchaser receives from us an acceptor's bill, this reservation of proprietary rights shall secure our claims under our right of recourse against the purchaser in case of any recourse based on the bill.

2. Processing, converting and incorporating with other products shall be carried out for us as the manufacturer, yet without any risk on our part. If due to incorporation, our (co) ownership shall cease, it shall be agreed even now, that the (co) ownership in the new product shall devolve to us on the pro rata basis of its invoice value of our product to the other products at the time of processing. Purchaser shall hold our (co) property in trust for us free of charge. Any products in which we have a co-ownership, shall be termed 'reserved goods'.

3. Purchaser shall be entitled to process and sell the reserved goods in the ordinary course of business, in as much as the purchaser discharges its business relationship obligations towards us in due time. Any authorization to transfer the sale to any third parties shall be excluded if between the purchaser of the reserved goods and its clients a covenant against assignment is in existence. The purchaser shall not be entitled to pawn the reserved goods, nor pledge them as collateral security. Purchaser shall assign to us even now by way of collateral security any outstanding accounts and rights in the sale goods or in any other respect, (e.g. insurance, illicit act regarding the reserved goods).

If we have only a co-ownership in any reserved product, the anticipatory assignment shall be limited to the part of the claim in keeping with the participation of our co-ownership (based on the invoice amounts).

4. Purchaser shall be authorized revocably by us to collect any outstanding accounts on its own account and in its own name. This collecting authority can be revoked if the purchaser does not discharge its contractual payment obligations towards us in due time. In case of a justified revocation, the purchaser shall be obliged to name any debtor/s of the assigned outstanding accounts and inform such debtor/s of the assignment.

This will apply particularly if any third party shall assert any warranty claim in opposition to the purchaser's accrued outstanding accounts.

Price reductions due to defects and set-offs due to compensation for damage have to be set off against any part of the outstanding accounts not assigned to us. In as much as the purchaser has agreed to a preferred partial assignment in favour of other trade creditor, this section shall apply with the purpose, that the purchaser may collect the partial outstanding accounts ceded to us jointly with the preferred partial outstanding accounts.

5. Purchaser shall be obliged to inform us without delay of any third party's execution enforced on the reserved goods and shall instruct such third party about their being our property.
6. If purchaser is in default - such as delay of payments - we shall be entitled to request a temporary surrender of the reserved goods without granting a grace period, and at purchaser's expense - in handing over or dispatching the goods to us - or possibly requesting assignment of purchaser's rights of recovery towards any third party.

Such surrender or seizure of the preferred goods to and by us does not imply contract withdrawal. This section shall also apply if a serious deterioration of the purchasers' assets becomes evident.

7. Upon purchaser's request we agree at our own discretion to release the above collateral securities, in as much as the amount exceeds the value of our claim to be secured by more than 10%.
8. Purchaser shall also cede to us its claims to secure our claims against purchaser, which due to the connection of the purchased matter with a piece of real estate will be raised against any third party.
9. We shall be entitled to insure the reserved goods against all risks of any kind at purchaser's expense, unless upon being requested by us, the purchaser submits evidence of a respective insurance policy. Any part amount owing to us claimed and paid out of this insurance shall be ceded to us in advance when entering into any respective contract. We shall be entitled to inform the insurance company of such cession.

## Section IV Delivery and Lead Time

1. Unless any deviating specification is to be found in the order confirmation, delivery shall be "ex works" e.g. "ex warehouse". The risk of loss or damage of the goods shall pass to the purchaser as soon as the goods have been handed over to the haulage contractor, latest when they are removed from our warehouse. This holds also true if "carriage or freight paid" has been agreed, and in case of partial deliveries or if any additional services of some other kind have been performed out by us.

2. Insurance of the goods against any transport risks shall take place only upon purchaser's express request and at purchaser's costs.

3. Delivery quoted by us shall commence only when all technical details have been clarified and will not be binding, unless a commercial transaction at a fixed



date has been expressly agreed. Lead times shall commence upon receipt of our order confirmation. Date of delivery shall mean receipt of the goods in the home country.

4. To an extent reasonable for the purchaser, we shall be free to carry out partial deliveries.

5. We shall be entitled to delay or cancel delivery expected from us or to reduce the amount delivered if we are prevented from or hindered in or delayed through any circumstances beyond our control as for instance strikes, lock-outs, transport obstacles, shortage or out of stock of raw materials, measures taken by public authorities – also experienced by our suppliers – during any period such as force majeure, conditions will subsist. Damages – as far as legally permissible – may not be claimed under these conditions.

6. If purchaser suffers any damage due to any delay caused by us, purchaser shall be entitled to compensation. Such entitlement shall be justified if we have not observed a given period of grace granted by the purchaser to remedy any defects. The compensation amount shall be a maximum of 1% per week, but not more than 5% in total, of the delayed part of the overall shipment which has not been available in time. Any further claims shall be excluded, unless the delay is due to at least gross negligence.

If purchaser delays acceptance of the goods or culpably fails to cooperate, we shall be entitled to request purchaser to remunerate any damage suffered by us including any possible additional costs. In this case the risk of loss or damage of the purchased goods will devolve to the purchaser, as soon as purchaser is in delay of acceptance of the goods.

7. Should the customer require a Proof of Delivery (POD) on the ordered goods, they will be required to pay a handling fee, provided that the goods were delivered to the consignee in accordance with the given instructions. A POD can only be requested by the customer within the usual retention period for the corresponding documentation of the haulier or carrier engaged. After this period the delivery requirements will be deemed to have been met.

## Section V Warranties and Limitation of Liabilities

1. Warranties are based on the proviso of tests and requirements to give notice of defects pursuant to § 377 of the German Commercial Code which have been carried out and complied with.

2. If any defect in the purchased product becomes evident, we shall be entitled either to remedy the defect or to replace the defective product delivered.

3. If we are not prepared or not able to remedy the defect /replace the defective product, or if due to any deficiency on our part such remedy is delayed beyond a suitable time, or if such remedy/replacement will miscarry for some reason or other, the purchaser shall have the option to withdraw from contract or to claim a respective reduction of the purchase price.

A reimbursement of expenses is excluded, insofar as the expenditure arises, due to the goods being brought to a different place following our delivery, unless this is required for the agreed use of the goods.

4. Unless in the following sections nothing to the contrary will be defined, any further purchaser's claims shall be excluded - irrespective of any legal reasons whatsoever. For any damage not incurred on the delivered product itself, we shall not be liable. Neither shall we be liable for any losses suffered in purchaser's profits or property.

5. The limitation of claims for material defects, should nothing else be agreed, is guided by the law.

6. The customer's legal right to make a claim for compensation against us arises only when the customer has not reached an agreement with his purchaser that goes beyond his statutory rights. Clause 3 of the last sentence is additionally valid concerning the extent of the claims for compensation.

7. The above release from liability shall not apply if the cause of damage is due to intentional or gross negligence (except if the damage was incurred due to the gross negligence of a person employed in performing an obligation or by any vicarious agent, or the damage is based on the violation of a major contractual obligation). Furthermore, the obligation to render compensation / liability to pay damages shall be limited to the damage likely to be expected.

8. Any delivery is according to current law - and those legal provisions which will be effective at a later date - of the European Union and The Federal Republic of Germany, e.g. REACH-regulation (regulation EG no. 1907/2006) and the law of return and ecological disposal of electrical equipment (ElektroG) as national implementation of the directive 2002/95/EG (RoHS) and the directive

2002/96/EG (WEEE).

## Section VI Joint and Several Liability

1. The limitation or exclusion of liabilities for compensation of damage referred to in section V shall apply in like manner to all claims due to default in contract conclusion, violation of subsidiary duties, in particular to claims arising out of producer's liability as set out in § 823 of the German Civil Code.

2. The regulation specified in section VI. 1 shall not apply to claims according to §§ 1.4 of the product liability law. Neither shall it apply to cases of initial incapacity or evident impossibility.

3. In as much as our liability is excluded, such an exclusion also applies to the personal liability of our staff, employees, agents and vicarious agents.

4. Any deviation in technology or construction of descriptions or specifications in sales literature, catalogues, and written documentation as well as any changes in prototypes, constructions, and materials, made in the course of technical progress, shall be reserved, without any interpretation of rights being permissible against us, in as much as this will still be acceptable to the purchaser.

## Section VII Usage Rights for Images

Any kind of exploitation or other use of photographs or other copyrighted contents which Brilliant AG on a website it maintains or publicly reproduces or makes available in any other way is prohibited. However, use can be permitted by Brilliant AG in a separate agreement.

## Section VIII Data protection

The data of the Customer shall be stored and processed by us in compliance with the statutory provisions.

## Section IX Return of goods

1. The return of defect-free goods requires our prior written agreement, otherwise we are entitled to refuse to accept the goods.

2. If we have expressly agreed to the return of the goods in accordance with clause 1. above or we accept returned defect-free goods, we are entitled to invoice the Customer with processing costs to the amount of 30 % of the net sales price. Furthermore, the Customer shall pay all transport costs as well as the costs for packaging, surrounding packaging and any repair.

## Section X Place of Performance, Legal Venue, and Applicable Law

1. Place of performance for our deliveries ex works shall be such selfsame works, if delivered ex warehouse, it shall be such selfsame warehouse. Place of performance for payments shall be Gnarrenburg.

2. Place of jurisdiction for all payment matters and any other disputes arising directly or indirectly from this contractual relationship is Hamburg. We reserve the right however to take legal action against the purchaser at his general place of jurisdiction. Hamburg shall be the exclusive legal venue for any across border deliveries for all litigations arising from the contract relationship.

(Art. 17, EU-GVÜ).

We reserve the right to invoke any other competent EU-GVÜ court.

3. For all business relationships and all legal relationships between the purchaser and us, solely the law of the Federal Republic of Germany shall apply. The uniform law concerning the international purchase of movable objects (EKG), as well as the United Nations Convention regarding international contracts on the purchase of goods (CISG) shall not apply.

Brilliant Aktiengesellschaft (PLC)  
Issued August 2016

## I. Allgemeines / Geltungsbereich / Angebot

1. Unsere Verkaufs- und Lieferbedingungen gelten ausschließlich; entgegenstehende oder von unseren Verkaufs- und Lieferbedingungen abweichende Bedingungen des Käufers erkennen wir nicht an, es sei denn, wir hätten ausdrücklich schriftlich ihrer Geltung zugestimmt.

Unsere Verkaufs- und Lieferbedingungen gelten auch dann, wenn wir in Kenntnis entgegenstehender oder von unseren Verkaufsbedingungen abweichender Bedingungen des Käufers die Lieferung an den Käufer vorbehaltlos ausführen. Einem Abtretungsverbot in Bedingungen des Käufers wird ausdrücklich widersprochen.

2. Alle Vereinbarungen, die zwischen uns und dem Käufer zwecks Ausführung des Vertrages getroffen werden, sind schriftlich niederzulegen.

3. Unsere Verkaufs- und Lieferbedingungen gelten auch für alle künftigen Geschäfte mit dem Käufer.

4. Unsere Angebote sind freibleibend und unverbindlich. Auf Bestellungen hin kommen alle Verträge erst mit Zugang unserer schriftlichen Auftragsbestätigung, spätestens mit Übergabe der Ware, zustande. Bestellungen können wir innerhalb von vier Wochen annehmen.

## II. Preise / Fracht / Zahlungsbedingungen

1. Die Preise verstehen sich netto zuzüglich Mehrwertsteuer und Fracht ab Werk oder Lager; es sei denn, es ist ausdrücklich und schriftlich etwas anderes vereinbart. Bei Aufträgen über einem Warennettowert von Euro 750,- verzichtet Brilliant AG auf die Geltendmachung der Fracht. Bei einem Warennettowert von Euro 750,- oder weniger berechnet Brilliant AG im Inland pauschal eine Frachtrate von 7% des Warennettwertes, mindestens jedoch Euro 12,50.

2. Die Zahlung des Kaufpreises hat innerhalb der vereinbarten Frist, mangels anderer Vereinbarungen innerhalb von 10 Tagen ab Rechnungsdatum netto zu erfolgen.

3. Wechsel und Schecks nehmen wir nur nach vorheriger Vereinbarung und unter Vorbehalt ihrer Diskontierbarkeit entgegen. Sämtliche Diskontspesen gehen zu Lasten des Kunden und sind uns sofort zu vergüten. Eine Gutschrift der Wechsel- und Scheckbeträge erfolgt erst dann, wenn uns der Gegenwert endgültig zur Verfügung steht.

4. Bei Überschreitungen des Zahlungsziels sind wir berechtigt, Verzugszinsen in Höhe von 8% über dem jeweiligen Basiszinssatz gem. § 247 BGB zu fordern. Falls wir in der Lage sind, einen höheren Verzugschaden nachzuweisen, sind wir berechtigt, diesen geltend zu machen. Der Käufer ist seinerseits berechtigt, uns nachzuweisen, dass uns als Folge des Zahlungsverzugs kein oder ein wesentlich geringerer Schaden entstanden ist.

5. Kommt der Käufer bis Fälligkeit seinen Zahlungsverpflichtungen nicht nach oder liegt eine wesentliche Vermögensverschlechterung bei ihm vor, so sind wir berechtigt, die gesamte Restschuld fällig zu stellen, auch wenn wir bereits Wechsel oder Schecks angenommen haben.

Wir sind in dem Fall außerdem berechtigt, Vorauszahlungen oder Sicherheitsleistungen zu verlangen und die Erfüllung unserer Verpflichtung bis zur Vorauszahlung oder Sicherheitsleistung zu verweigern. Wird unser Verlangen binnen einer von uns gesetzten angemessenen Frist nicht erfüllt, so sind wir berechtigt, vom Vertrag zurückzutreten und/oder Schadensersatz wegen Nichterfüllung zu verlangen. Bei Zahlungseinstellung oder Überschuldung des Käufers entfällt die Setzung einer Nachfrist.

6. Aufrechnungsrechte stehen dem Käufer nur zu, wenn seine Gegenansprüche rechtskräftig festgestellt, unbestritten oder von uns anerkannt sind.

Wegen bestrittener Gegenansprüche steht dem Käufer auch kein Zurückbehaltungsrecht zu.

7. Im Falle des Verzuges mit mehr als einer Verbindlichkeit sind die gesamten Forderungen gegen den Käufer sofort zur Zahlung fällig.

8. Unsere Forderungen sind an die Deutsche Factoring Bank, Bremen, abgetreten.

## III. Eigentumsvorbehalt

1. Sämtliche gelieferte Sachen bleiben bis zur Erfüllung aller Forderungen, die uns aus jedem Rechtsgrund gegen den Käufer jeweils zustehen, unser alleiniges Eigentum. Wird dem Käufer bei Zahlung ausnahmsweise von uns ein „umgedrehter Wechsel“ (Akzeptanten-Wechsel) gegeben, so sichert der

Eigentumsvorbehalt auch unsere Rückgriffsansprüche gegen den Käufer bei einer eventuellen Inanspruchnahme aus dem Wechsel.

2. Verarbeitung, Umbildung und Vermischung erfolgen stets für uns als Hersteller, jedoch ohne Verpflichtung für uns. Erlischt unser (Mit-)Eigentum durch Verbindung oder Vermischung, so wird bereits jetzt vereinbart, dass das (Mit-)Eigentum an der neuen Sache im Verhältnis des Rechnungswertes unserer Sache zu denen anderer verarbeitender Waren zur Zeit der Verarbeitung auf uns übergeht. Der Käufer verwahrt unser (Mit-)Eigentum unentgeltlich. Sachen, an denen uns (Mit-)Eigentum zusteht, werden im folgenden als „Vorbehaltsware“ bezeichnet.

3. Der Käufer ist berechtigt, die Vorbehaltsware im ordnungsgemäßen Geschäftsverkehr zu verarbeiten und zu veräußern, solange er mit seinen Zahlungsverpflichtungen uns gegenüber nicht im Verzug ist.

Die Ermächtigung zur weiteren Veräußerung wird ausgeschlossen für den Fall, dass im Verhältnis zwischen dem Vorbehaltskäufer und seinem Kunden ein Abtretungsverbot besteht. Verpfändungen oder Sicherungsübereignungen sind unzulässig. Die aus dem Weiterverkauf oder einem sonstigen Rechtsgrund (z. B. Versicherung, unerlaubter Handlung bezüglich der Vorbehaltsware) entstandenen Forderungen tritt der Käufer bereits jetzt sicherungshalber an uns ab. Steht uns nur Miteigentum an einer Vorbehaltsware zu, so beschränkt sich die Vorausabtretung auf den Teil der Forderung, der dem Anteil unseres Miteigentums (auf der Basis des Rechnungswertes) entspricht.

4. Wir ermächtigen den Käufer widerruflich, die an uns abgetretenen Forderungen für eigene Rechnungen im eigenen Namen einzuziehen. Diese Einziehungsermächtigung kann widerrufen werden, wenn der Käufer seinen Zahlungsverpflichtungen nicht ordnungsgemäß nachkommt.

Für den Fall eines berechtigten Widerrufs hat uns der Käufer den/die Schuldner der abgetretenen Forderung mitzuteilen und dem/den Schuldner(n) die Abtretung unverzüglich anzuzeigen. Der an uns abgetretene Forderungsteil hat den Vorrang. Dies gilt insbesondere für den Fall, dass der Dritte der dem Käufer erwachsene Forderung Gewährleistungsansprüche entgegenhält.

Minderungen und Aufrechnungen mit Schadensersatzansprüchen sind zuerst auf den uns nicht abgetretenen Forderungsanteil zu verrechnen. Soweit der Käufer eine bevorrechtigte Teilabtretung auch zugunsten anderer Warenkreditgeber vereinbart hat, gilt diese Ziffer mit der Maßgabe, dass der Käufer die uns abgetretene Teilforderung zugleich mit jenen bevorrechtigten Teilforderungen einziehen darf.

5. Bei Zugriffen Dritter auf Vorbehaltsware wird der Käufer auf unser Eigentum hinweisen und uns unverzüglich benachrichtigen.

6. Bei vertragswidrigem Verhalten des Käufers - insbesondere Zahlungsverzug - sind wir berechtigt, die Vorbehaltsware auch ohne Nachfristsetzung auf Kosten des Käufers einstweilen herauszuverlangen - durch Herausgabe oder Rücksendung an uns - oder ggf. Abtretung der Herausgabeansprüche des Käufers gegen Dritte zu fordern.

In der Zurücknahme sowie in der Pfändung der Vorbehaltsware durch uns liegt - soweit nicht das Verbraucherkreditgesetz Anwendung findet - kein Rücktritt vom Vertrag. Die vorstehende Regelung findet auch Anwendung im Falle einer wesentlichen Vermögensverschlechterung beim Käufer.

7. Die vorgenannten Sicherheiten geben wir auf Verlangen des Käufers nach unserer Wahl frei, soweit ihr Wert unsere Forderung um mehr als 10% übersteigt.

8. Der Käufer tritt uns auch die Forderungen zur Sicherung unserer Forderungen gegen ihn ab, die durch die Verbindung der Kaufsache mit einem Grundstück gegen einen Dritten erwachsen.

9. Wir sind berechtigt, die Vorbehaltsware gegen Gefahren aller Art auf Kosten des Käufers zu versichern, sofern er nicht nach einer entsprechenden Anforderung durch uns den Abschluss einer derartigen Versicherung nachweist. Ansprüche aus dieser Versicherung werden in Höhe der uns zustehenden Forderungen mit Abschluss des jeweiligen Vertrages im voraus an uns abgetreten. Wir sind berechtigt, die Abtretung dem Versicherer anzuzeigen.

## IV. Lieferung und Lieferzeit

1. Sofern sich aus der Auftragsbestätigung nichts anderes ergibt, ist Lieferung „ab Werk“ bzw. „ab Lager“ vereinbart. Die Gefahr des Untergangs oder der Beschädigung der Ware geht in dem Zeitpunkt auf den Käufer über, in welchem wir die Ware an einen Spediteur oder Frachtführer übergeben, spätestens jedoch mit Verlassen unseres Lagers. Dies gilt auch dann, wenn „frachtfrei“ vereinbart worden ist sowie bei Teillieferung oder wenn von uns noch Leistungen anderer Art übernommen worden sind.

2. Eine Versicherung der Ware gegen Transportschäden erfolgt nur auf ausdrücklichen Wunsch und Kosten des Käufers.

3. Der Beginn der von uns angegebenen Lieferzeit setzt die Klärung aller technischen Fragen voraus und ist unverbindlich, sofern nicht ausdrücklich ein kaufmännisches Fixgeschäft vereinbart wurde. Lieferfristen beginnen mit dem Zugang unserer Auftragsbestätigung. Der Liefertermin bezeichnet den Eingang beim Kunden im Inland.

4. Zu Teilleistungen sind wir in für den Käufer zumutbarem Umfang berechtigt.

5. Wird die von uns geschuldete Lieferung durch unvorhersehbare und von uns unverschuldete Umstände verzögert (z. B. Arbeitskämpfe, Betriebsstörungen, Transporthindernisse, Rohmaterialmangel, behördliche Maßnahmen - jeweils auch bei unseren Vorlieferanten - sowie nicht rechtzeitige Selbstbelieferung), so sind wir berechtigt, ganz oder teilweise vom Vertrag zurückzutreten oder nach unserer Wahl die Belieferung um die Dauer der Behinderung hinauszuschieben. Schadensersatzansprüche sind - soweit rechtlich zulässig - ausgeschlossen.

6. Sollte dem Käufer aufgrund eines von uns verschuldeten Verzuges ein Schaden erwachsen, so ist er berechtigt, eine Verzugsentschädigung zu fordern. Das Recht zur Geltendmachung setzt voraus, dass wir eine vom Käufer schriftlich gesetzte angemessene Nachfrist nicht eingehalten haben. Die Höhe der Verzugsentschädigung beträgt für jede volle Woche des Verzuges maximal 1%, insgesamt aber höchstens 5% vom Wert desjenigen Teils der Gesamtlieferung, der infolge der Verspätung nicht rechtzeitig zur Verfügung steht. Darüber hinausgehende Ansprüche sind ausgeschlossen, es sei denn, der Verzug beruht auf zumindest grober Fahrlässigkeit. Kommt der Käufer in Annahmeverzug oder unterlässt er schuldhaft die Mitwirkungspflichten, so sind wir berechtigt, von ihm zu verlangen, den uns entstandenen Schaden einschließlich etwaiger Mehraufwendungen zu ersetzen. In dem Fall geht auch die Gefahr eines zufälligen Untergangs oder einer zufälligen Verschlechterung der Kaufsache in dem Zeitpunkt auf den Käufer über, in dem dieser in Annahmeverzug gerät.

7. Verlangt der Käufer einen Liefernachweis für bestellte Ware, hat er die Nachforschungsgebühren zu tragen, sofern die Ware ordnungsgemäß beim Empfänger abgeliefert wurde. Diesen Nachweis kann der Käufer nur innerhalb der üblichen Aufbewahrungsfrist der entsprechenden Dokumente beim beauftragten Spediteur oder Frachtführer verlangen. Nach Ablauf dieser Frist gilt die Lieferungsleistung als erbracht.

## V. Gewährleistungen und Haftungsbeschränkungen

1. Gewährleistungsansprüche setzen voraus, dass die Untersuchungs- und Rügeobliegenheiten der § 377 HGB beachtet wurden.

2. Soweit ein von uns zu vertretener Mangel der Kaufsache vorliegt, sind wir nach unserer Wahl zur Mängelbeseitigung oder Ersatzlieferung berechtigt.

3. Sind wir zur Mängelbeseitigung/Ersatzlieferung nicht bereit oder in der Lage, insbesondere verzögert sich diese über angemessene Fristen hinaus aus Gründen, die wir zu vertreten haben, oder schlägt in sonstiger Weise die Mängelbeseitigung/Ersatzlieferung fehl, so ist der Käufer nach seiner Wahl berechtigt, vom Vertrag zurückzutreten oder eine entsprechende Minderung des Kaufpreises zu verlangen. Eine Kostenerstattung ist ausgeschlossen, soweit die Aufwendungen sich erhöhen, weil die Ware nach unserer Lieferung an einen anderen Ort verbracht worden ist, es sei denn, dies entspricht dem bestimmungsmäßigen Gebrauch der Ware.

4. Soweit sich nachstehend nichts anderes ergibt, sind weitergehende Ansprüche des Käufers - gleich, aus welchen Rechtsgründen - ausgeschlossen. Wir haften deshalb nicht für Schäden, die nicht am Liefergegenstand selbst entstanden sind. Insbesondere haften wir nicht für entgangenen Gewinn oder sonstige Vermögensschäden des Käufers.

5. Die Verjährung der Sachmängelansprüche richtet sich, soweit nichts anderes vereinbart ist, nach dem Gesetz.

6. Gesetzliche Rückgriffsansprüche des Käufers gegen uns bestehen nur insoweit, als der Käufer mit seinem Abnehmer keine Vereinbarungen getroffen hat, die über die gesetzlichen Mängelansprüche hinausgehen. Für den Umfang der Rückgriffsansprüche gilt ferner Ziff. 3 letzter Satz entsprechend.

7. Vorstehende Haftungsfreizeichnung gilt nicht, soweit die Schadensursache auf Vorsatz oder grober Fahrlässigkeit beruht (ausgenommen, wenn der Schaden durch grobe Fahrlässigkeit eines Erfüllungs- oder Verrichtungsgehilfen verursacht wurde, es sei denn, der Schaden beruht auf Verletzung einer vertraglichen Hauptpflicht). Im Übrigen ist die Ersatzpflicht auf den vorhersehbaren Schaden begrenzt.

8. Bei unseren Lieferungen halten wir die bei Vertragsschluss und später geltenden gesetzlichen Regelungen der Europäischen Union und der Bundesrepublik

Deutschland ein, z.B. die REACH-Verordnung (Verordnung EG Nr. 1907/2006) und das Gesetz über die Rücknahme und umweltverträgliche Entsorgung von Elektro- und Elektronikgeräten (ElektroG) als nationale Umsetzung der Richtlinie 2002/95/EG (RoHS) und der Richtlinie 2002/96/EG (WEEE).

## VI. Gesamthaftung

1. Soweit gemäß Ziff. V. unsere Haftung auf Schadenersatz ausgeschlossen oder beschränkt ist, gilt dies auch für alle Ansprüche wegen Verschuldens bei Vertragsschluss, Verletzung von Nebenpflichten, insbesondere für Ansprüche aus Produzentenhaftung gemäß § 823 BGB.

2. Die Regelung gemäß Ziff. VI. 1. gilt nicht für Ansprüche gemäß den §§ 1, 4 Produkthaftungsgesetz. Gleiches gilt bei anfänglichem Unvermögen oder zu vertretender Unmöglichkeit.

3. Soweit unsere Haftung ausgeschlossen oder beschränkt ist, gilt dies auch für die persönliche Haftung unserer Angestellten, Arbeitnehmer, Mitarbeiter, Vertreter und Erfüllungsgehilfen.

4. Technische und gestalterische Abweichung von Beschreibungen und Angaben in Prospekten, Katalogen und schriftlichen Unterlagen sowie Modell-, Konstruktions- und Materialänderung im Zuge des technischen Fortschritts bleiben vorbehalten, ohne dass hieraus Rechte gegen uns hergeleitet werden können, soweit dies für den Käufer noch zumutbar ist.

## VII. Bildnutzungsrechte

Jede Art der Verwertung oder sonstiger Nutzung von Fotografien oder sonstigem urheberrechtlich geschützten Inhalten, welche die Brilliant AG auf einer von ihr unterhaltenen Internetseite verwendet oder in sonstiger Weise öffentlich wiedergibt oder bereit hält, ist untersagt. Die Nutzung kann jedoch in einer besonderen Vereinbarung durch die Brilliant AG gestattet werden.

## VIII. Datenschutz

Die Daten des Käufers werden unter Beachtung der gesetzlichen Vorschriften von uns gespeichert und verarbeitet.

## IX. Warenrücknahme

1. Die Rücksendung mangelfreier Ware setzt unser vorheriges schriftliches Einverständnis voraus. Anderenfalls sind wir berechtigt, die Annahme der Ware zu verweigern.

2. Haben wir uns mit der Rücksendung der Ware gemäß vorstehender Ziffer 1. einverstanden erklärt oder nehmen wir zurückgesandte mangelfreie Ware an, sind wir berechtigt, dem Käufer Bearbeitungskosten in Höhe von 30 % des Netto-Verkaufspreises zu berechnen. Ferner hat der Käufer sämtliche Transportkosten sowie Kosten der Verpackung, Umverpackung und eventuellen Instandsetzung zu tragen.

## X. Erfüllungsort, Gerichtsstand und anzuwendendes Recht

1. Erfüllung für unsere Lieferung ist bei Lieferung ab Werk das Lieferwerk, bei Lieferung ab Lager das Lager. Erfüllungsort für Zahlungen ist Gnarrenburg.

2. Gerichtsstand in Zahlungsangelegenheiten und in allen anderen sich aus diesem Vertragsverhältnis unmittelbar oder mittelbar ergebenden Streitigkeiten ist Hamburg. Wir haben jedoch das Recht, den Käufer an seinem allgemeinen Gerichtsstand zu verklagen. Auch bei grenzüberschreitender Lieferung ist ausschließlich Gerichtsstand für alle Streitigkeiten aus dem Vertragsverhältnis Hamburg (Art. 17 EU-GVÜ). Wir behalten uns das Recht vor, auch jedes andere Gericht anzurufen, das aufgrund des EU-GVÜ zuständig ist.

3. Für alle Geschäftsbeziehungen und die gesamten Rechtsbeziehungen zwischen dem Kunden und uns gilt ausschließlich das Recht der Bundesrepublik Deutschland. Die Anwendung des einheitlichen Gesetzes über den internationalen Kauf beweglicher Sachen (EKG) sowie des Übereinkommens der Vereinten Nationen über Verträge über den internationalen Warenkauf (CISG) ist ausgeschlossen.

Brilliant AG  
Stand 08/16

Name / Art. Nr.	Page	Name / Art. Nr.	Page	Name / Art. Nr.	Page	Name / Art. Nr.	Page
<b>A</b>		<b>BERGEN</b>	G40097/82	<b>F</b>		<b>INTERFACE</b>	98379/63
AALBORG	44081/82	31	<b>BERNA</b>	41070/06	43	<b>INTERFACE</b>	98380/63
AALBORG	44084/82	31	<b>BERNA</b>	41081/06	42	<b>INTERFACE</b>	98380/05
AALBORG	44085/82	31	<b>BERNA</b>	41087/06	42	<b>IRVIN</b>	96186/06
AALBORG	44097/82	31	<b>BOLE</b>	G96131/82	24	<b>IRVIN</b>	96186/05
AALBORG	G44081/82	30	<b>BOLE</b>	G46789/82	24	<b>ISTRIA</b>	48682/06
AALBORG	G44084/82	30	<b>BOLE</b>	G46798/82	24	<b>ISTRIA</b>	48684/06
AALBORG	G44085/82	30	<b>BOLE</b>	G46799/82	24	<b>ISTRIA</b>	48685/06
AALBORG	G44097/82	30	<b>BRICK</b>	96172/82	123	<b>ISTRIA</b>	48681/05
ADONIA	G96228/82	26	<b>C</b>			<b>ISTRIA</b>	48682/05
ARCHEA	G96239/06	13	<b>CARLISLE</b>	96288/55	74	<b>ISTRIA</b>	48684/05
ARCO	G96249/06	13	<b>CARLTON</b>	G96269/82	123	<b>ISTRIA</b>	48685/05
ARCTIC	G96285/82	18	<b>CASPAR</b>	96240/22	47	<b>ISTRIA</b>	48688/05
ARCTIC	G96302/82	18	<b>CASTING</b>	G96258/63	12	<b>ISTRIA</b>	48697/05
ARCTIC	G96303/82	18	<b>CELICA</b>	96130/82	55	<b>ISTRIA</b>	48697/06
ARCTIC	G96304/82	18	<b>CHORUS</b>	43684/82	27	<b>ISTRIA</b>	48670/06
ARLEY	96310/20	61	<b>CHORUS</b>	43697/82	26	<b>ISTRIA</b>	48688/06
ARLEY	96310/09	60	<b>CHORUS</b>	43699/82	27	<b>ISTRIA</b>	48670/05
ARLEY	96311/20	61	<b>CHORUS</b>	43685/82	27	<b>ISTRIA</b>	48681/06
ARLEY	96311/09	60	<b>CHORUS</b>	43693/82	27	<b>J</b>	
ARTO	96129/82	51	<b>CHORUS</b>	43681/82	26	<b>JANKO</b>	G96232/06
ARTOS	48581/06	115	<b>CROWN</b>	40281/05	102	<b>JANKO</b>	G96232/22
ARTOS	48581/11	115	<b>CROWN</b>	40281/06	100	<b>JASON</b>	43881/86
ARTU	96128/86	85	<b>CROWN</b>	40282/05	102	<b>JASON</b>	43882/86
ARTU	46970/86	84	<b>CROWN</b>	40282/06	100	<b>JASON</b>	43884/86
ARTU	46984/86	84	<b>CROWN</b>	40284/05	102	<b>JASON</b>	43897/86
ARTU	46985/86	84	<b>CROWN</b>	40284/06	101	<b>JASON</b>	43870/86
ARTU	46987/86	84	<b>CROWN</b>	40285/05	102	<b>JASON</b>	43885/86
ARTU	96128/30	86	<b>CROWN</b>	40297/05	102	<b>JERRY</b>	96105/11
ASHTON	G41681/06	9	<b>CROWN</b>	40285/06	101	<b>JORDY</b>	45582/60
ASHTON	G41685/06	9	<b>CROWN</b>	40288/06	101	<b>L</b>	
AVON	G43480/82	20	<b>CROWN</b>	40297/06	100	<b>LIDA</b>	45884/55
AVON	G43481/82	20	<b>D</b>			<b>LIDA</b>	45885/55
AVON	G43484/82	20	<b>DARIUS</b>	53524A05	124	<b>LIDA</b>	45880/55
AVON	G43485/82	20	<b>DARIUS</b>	G53500A05	124	<b>LIGHT STR. MUSIC</b>	G94432A72
<b>B</b>			<b>DARIUS</b>	G53500A75	124	<b>LUGANO</b>	96291/63
BALLINA	G96307/63	110	<b>DARIUS</b>	G53501A05	124	<b>LUNDY</b>	96292/63
BALLINA	G96307/05	110	<b>DARIUS</b>	G53501A75	124	<b>M</b>	
BALLINA	G96308/63	111	<b>DERBY</b>	G96268/82	123	<b>MADISON</b>	47281/82
BALLINA	G96308/05	111	<b>DEREK</b>	G66580/63	8	<b>MADISON</b>	47284/82
BEAS	96197/82	50	<b>DEREK</b>	G66585/63	8	<b>MADISON</b>	47285/82
BERGEN	G40081/63	21	<b>DEREK</b>	G66586/63	8	<b>MALMÖ</b>	96242/63
BERGEN	G40081/82	22	<b>DRAG</b>	96300/05	56	<b>MALMÖ</b>	96243/63
BERGEN	G40084/63	21	<b>E</b>			<b>MARITIM</b>	53680/06
BERGEN	G40084/82	22	<b>ELTON</b>	96184/05	115	<b>MARITIM</b>	53680/11
BERGEN	G40085/63	21	<b>ELTON</b>	96184/06	115	<b>MATHIS</b>	G96250/22
BERGEN	G40085/82	22	<b>EVERGREEN</b>	G96284/72	57	<b>MATTEO</b>	96233/63
BERGEN	G40097/63	21				<b>MATTEO</b>	96233/22

Name / Art. Nr.	Page	Name / Art. Nr.	Page	Name / Art. Nr.	Page	Name / Art. Nr.	Page
MEDWAY	G96053/05	109 PHILIPP	96108/82	117 TANKO	96162/05	119	
MEDWAY	G96053/63	109 PHILIPP	96109/82	117 TANKO	96162/06	120	
MEDWAY	G96309/63	108 PORTLAND	96297/06	75 TANKO	96163/05	119	
MEDWAY	G96309/05	108 PORTLAND	96297/55	75 TANKO	96163/06	121	
MUSIC	G94403/13	16 R		TANKO	96164/05	119	
<b>N</b>		<b>RAMONA</b>	96192/82	55 TANKO	96164/06	120	
NEIL	40381/82	33 REED	44680/63	62 TANKO	96161/22	118	
NEIL	40382/82	33 REED	44681/63	62 TANKO	96163/22	118	
NEIL	40384/82	33 REED	44685/63	63 TERRENCE	45781/82	34	
NEIL	40385/82	33 REED	44686/63	63 TERRENCE	45785/82	34	
NEVADA	41380/82	117 REED	44697/63	62 TERRENCE	45784/82	34	
NEWPORT	44281/06	97 REED	44670/63	63 TIBOR	G96231/06	122	
NEWPORT	44282/06	97 RILEY	42370/05	69 TILBURY	G96054/05	112	
NEWPORT	44284/06	96 RILEY	42370/06	67 TILBURY	G96054/63	112	
NEWPORT	44285/06	96 RILEY	42381/05	68 TODD	47682/82	36	
NEWPORT	44270/05	98 RILEY	42381/06	66 TODD	47698/82	36	
NEWPORT	44270/06	96 RILEY	42382/05	68 TODD	47682/05	39	
NEWPORT	44270/55	94 RILEY	42382/06	66 TODD	47682/63	38	
NEWPORT	44280/05	99 RILEY	42384/05	69 TODD	47684/05	39	
NEWPORT	44280/06	97 RILEY	42384/06	67 TODD	47684/63	38	
NEWPORT	44280/55	95 RILEY	42397/05	68 TODD	47684/82	36	
NEWPORT	44281/05	99 RILEY	42397/06	66 TODD	47685/05	39	
NEWPORT	44281/55	95 RILEY	42385/05	69 TODD	47685/63	38	
NEWPORT	44282/05	99 RILEY	42385/06	67 TODD	47685/82	37	
NEWPORT	44282/55	95 ROGER	41181/06	82 TODD	47698/05	39	
NEWPORT	44284/05	98 ROGER	41181/55	82 TODD	47698/63	38	
NEWPORT	44284/55	94 RUNE	96182/82	54 TODD	47681/55	83	
NEWPORT	44285/05	98 RUNE	96183/82	54 TRAVIS	G96305/63	11	
NEWPORT	44285/55	94 S		TWEETY	96107/05	116	
NEWPORT	44288/06	97 SENSOR	96193/05	118 TWEETY	96107/06	116	
NEWPORT	44288/55	95 SENSOR	96193/06	118 TYLER	96104/06	48	
NYX	G96293/63	76 SEVERIN	96157/82	35 TYLER	96104/11	48	
<b>O</b>		<b>SEVERIN</b>	96181/82	35 W			
OLENA	96301/70	76 SHISO	G44581/63	6 WARREN	G96251/06	14	
ORCO	G96244/63	10 SHISO	G44584/63	6 WARREN	G96251/58	14	
ORCO	G96245/63	10 SHISO	G44585/63	6 WHITNEY	46380/55	73	
OSKAR	46881/55	70 SHISO	G44597/63	6 WHITNEY	46394/55	73	
OSKAR	46884/55	71 SHISO	G44594/63	6 Y			
OSKAR	46885/55	70 SILVESTER	96106/05	116 YORK	44797/82	32	
OSKAR	46897/55	70 SILVESTER	96106/06	116 YORK	44799/82	32	
<b>P</b>		<b>SIMONE</b>	96191/82	55 YORK	44781/82	32	
PANEL	G42681/06	4 SKIPPER	48480/06	114 YORK	44785/82	32	
PANEL	G42684/06	4 SKIPPER	48480/11	114 YORK	44784/82	32	
PANEL	G42689/06	4 T		Z			
PANEL	G42697/06	4 TANKO	96159/06	120 ZEN	G96246/63	12	
PERTH	G96294/06	106 TANKO	96160/06	120			
PERTH	G96295/06	106 TANKO	96161/05	119			
PERTH	G96296/06	106 TANKO	96161/06	120			

Name / Art. Nr.	Page	Name / Art. Nr.	Page	Name / Art. Nr.	Page	Name / Art. Nr.	Page
<b>4</b>		43885/86 JASON	89	46380/55 WHITNEY	73	48697/05 ISTRIA	93
40281/05 CROWN	102	43897/86 JASON	88	46394/55 WHITNEY	73	48697/06 ISTRIA	91
40281/06 CROWN	100	44081/82 AALBORG	31	46881/55 OSKAR	70	G40081/63 BERGEN	21
40282/05 CROWN	102	44084/82 AALBORG	31	46884/55 OSKAR	71	G40081/82 BERGEN	22
40282/06 CROWN	100	44085/82 AALBORG	31	46885/55 OSKAR	70	G40084/63 BERGEN	21
40284/05 CROWN	102	44097/82 AALBORG	31	46897/55 OSKAR	70	G40084/82 BERGEN	22
40284/06 CROWN	101	44270/05 NEWPORT	98	46970/86 ARTU	84	G40085/63 BERGEN	21
40285/05 CROWN	102	44270/06 NEWPORT	96	46984/86 ARTU	84	G40085/82 BERGEN	22
40285/06 CROWN	101	44270/55 NEWPORT	94	46985/86 ARTU	84	G40097/63 BERGEN	21
40288/06 CROWN	101	44280/05 NEWPORT	99	46987/86 ARTU	84	G40097/82 BERGEN	22
40297/05 CROWN	102	44280/06 NEWPORT	97	47281/82 MADISON	29	G41681/06 ASHTON	9
40297/06 CROWN	100	44280/55 NEWPORT	95	47284/82 MADISON	29	G41685/06 ASHTON	9
40381/82 NEIL	33	44281/05 NEWPORT	99	47285/82 MADISON	29	G42681/06 PANEL	4
40382/82 NEIL	33	44281/06 NEWPORT	97	47681/55 TODD	83	G42684/06 PANEL	4
40384/82 NEIL	33	44281/55 NEWPORT	95	47682/05 TODD	39	G42689/06 PANEL	4
40385/82 NEIL	33	44282/05 NEWPORT	99	47682/63 TODD	38	G42697/06 PANEL	4
41070/06 BERNA	43	44282/06 NEWPORT	97	47682/82 TODD	36	G43281/82 FINNIGAN	28
41081/06 BERNA	42	44282/55 NEWPORT	95	47684/05 TODD	39	G43284/82 FINNIGAN	28
41087/06 BERNA	42	44284/05 NEWPORT	98	47684/63 TODD	38	G43285/82 FINNIGAN	28
41181/06 ROGER	82	44284/06 NEWPORT	96	47684/82 TODD	36	G43480/82 AVON	20
41181/55 ROGER	82	44284/55 NEWPORT	94	47685/05 TODD	39	G43481/82 AVON	20
41380/82 NEVADA	117	44285/05 NEWPORT	98	47685/63 TODD	38	G43484/82 AVON	20
42370/05 RILEY	69	44285/06 NEWPORT	96	47685/82 TODD	37	G43485/82 AVON	20
42370/06 RILEY	67	44285/55 NEWPORT	94	47698/05 TODD	39	G44081/82 AALBORG	30
42381/05 RILEY	68	44288/06 NEWPORT	97	47698/63 TODD	38	G44084/82 AALBORG	30
42381/06 RILEY	66	44288/55 NEWPORT	95	47698/82 TODD	36	G44085/82 AALBORG	30
42382/05 RILEY	68	44480/06 GAIA	64	47880/05 HOLLYWOOD	45	G44097/82 AALBORG	30
42382/06 RILEY	66	44482/06 GAIA	64	47880/06 HOLLYWOOD	44	G44581/63 SHISO	6
42384/05 RILEY	69	44670/63 REED	63	47884/05 HOLLYWOOD	45	G44584/63 SHISO	6
42384/06 RILEY	67	44680/63 REED	62	47884/06 HOLLYWOOD	44	G44585/63 SHISO	6
42385/05 RILEY	69	44681/63 REED	62	47885/05 HOLLYWOOD	45	G44594/63 SHISO	6
42385/06 RILEY	67	44685/63 REED	63	47897/05 HOLLYWOOD	45	G44597/63 SHISO	6
42397/05 RILEY	68	44686/63 REED	63	48480/06 SKIPPER	114	G46789/82 BOLE	24
42397/06 RILEY	66	44697/63 REED	62	48480/11 SKIPPER	114	G46798/82 BOLE	24
43580/63 GAP	40	44781/82 YORK	32	48581/06 ARTOS	115	G46799/82 BOLE	24
43584/63 GAP	41	44784/82 YORK	32	48581/11 ARTOS	115	<b>5</b>	
43585/63 GAP	40	44785/82 YORK	32	48670/05 ISTRIA	93	53524A05 DARIUS	124
43597/63 GAP	40	44797/82 YORK	32	48670/06 ISTRIA	91	53680/06 MARITIM	114
43681/82 CHORUS	26	44799/82 YORK	32	48681/05 ISTRIA	92	53680/11 MARITIM	114
43684/82 CHORUS	27	45482/55 FITZROY	78	48681/06 ISTRIA	90	G53500A05 DARIUS	124
43685/82 CHORUS	27	45484/55 FITZROY	78	48682/05 ISTRIA	93	G53500A75 DARIUS	124
43693/82 CHORUS	27	45582/60 JORDY	83	48682/06 ISTRIA	91	G53501A05 DARIUS	124
43697/82 CHORUS	26	45781/82 TERRENCE	34	48684/05 ISTRIA	92	G53501A75 DARIUS	124
43699/82 CHORUS	27	45784/82 TERRENCE	34	48684/06 ISTRIA	90	<b>6</b>	
43870/86 JASON	89	45785/82 TERRENCE	34	48685/05 ISTRIA	92	G66580/63 DEREK	8
43881/86 JASON	88	45880/55 LIDA	72	48685/06 ISTRIA	90	G66585/63 DEREK	8
43882/86 JASON	88	45884/55 LIDA	72	48688/05 ISTRIA	93	G66586/63 DEREK	8
43884/86 JASON	89	45885/55 LIDA	72	48688/06 ISTRIA	91		

Name / Art. Nr.	Page	Name / Art. Nr.	Page	Name / Art. Nr.	Page	Name / Art. Nr.	Page	
<b>9</b>		<b>96288/55</b>	CARLISLE	74	<b>G96245/63</b>	ORCO	10	
96104/06	TYLER	48	<b>96290/63</b>	HUMPHREY	77	<b>G96246/63</b>	ZEN	12
96104/11	TYLER	48	<b>96291/63</b>	LUGANO	49	<b>G96249/06</b>	ARCO	13
96105/11	JERRY	115	<b>96292/63</b>	LUNDY	74	<b>G96250/22</b>	MATHIS	15
96106/05	SILVESTER	116	<b>96297/06</b>	PORTLAND	75	<b>G96251/06</b>	WARREN	14
96106/06	SILVESTER	116	<b>96297/55</b>	PORTLAND	75	<b>G96251/58</b>	WARREN	14
96107/05	TWEETY	116	<b>96300/05</b>	DRAG	56	<b>G96254/82</b>	HANNI	53
96107/06	TWEETY	116	<b>96301/70</b>	OLENA	76	<b>G96255/82</b>	HANNI	53
96108/82	PHILIPP	117	<b>96310/09</b>	ARLEY	60	<b>G96258/63</b>	CASTING	12
96109/82	PHILIPP	117	<b>96310/20</b>	ARLEY	61	<b>G96268/82</b>	DERBY	123
96128/30	ARTU	86	<b>96311/09</b>	ARLEY	60	<b>G96269/82</b>	CARLTON	123
96128/86	ARTU	85	<b>96311/20</b>	ARLEY	61	<b>G96284/72</b>	EVERGREEN	57
96129/82	ARTO	51	<b>98190/63</b>	INTERFACE	133	<b>G96285/82</b>	ARCTIC	18
96130/82	CELICA	55	<b>98190/82</b>	INTERFACE	133	<b>G96293/63</b>	NYX	76
96157/82	SEVERIN	35	<b>98193/05</b>	INTERFACE	133	<b>G96294/06</b>	PERTH	106
96159/06	TANKO	120	<b>98193/55</b>	INTERFACE	133	<b>G96295/06</b>	PERTH	106
96160/06	TANKO	120	<b>98194/63</b>	INTERFACE	134	<b>G96296/06</b>	PERTH	106
96161/05	TANKO	119	<b>98194/82</b>	INTERFACE	134	<b>G96302/82</b>	ARCTIC	18
96161/06	TANKO	120	<b>98197/63</b>	INTERFACE	138	<b>G96303/82</b>	ARCTIC	18
96161/22	TANKO	118	<b>98197/82</b>	INTERFACE	138	<b>G96304/82</b>	ARCTIC	18
96162/05	TANKO	119	<b>98198/63</b>	INTERFACE	138	<b>G96305/63</b>	TRAVIS	11
96162/06	TANKO	120	<b>98198/82</b>	INTERFACE	138	<b>G96306/63</b>	HARPER	11
96163/05	TANKO	119	<b>98200/05</b>	INTERFACE	139	<b>G96307/05</b>	BALLINA	110
96163/06	TANKO	121	<b>98200/55</b>	INTERFACE	139	<b>G96307/63</b>	BALLINA	110
96163/22	TANKO	118	<b>98371/63</b>	INTERFACE	139	<b>G96308/05</b>	BALLINA	111
96164/05	TANKO	119	<b>98371/82</b>	INTERFACE	139	<b>G96308/63</b>	BALLINA	111
96164/06	TANKO	120	<b>98372/63</b>	INTERFACE	132	<b>G96309/05</b>	MEDWAY	108
96172/82	BRICK	123	<b>98372/82</b>	INTERFACE	132	<b>G96309/63</b>	MEDWAY	108
96181/82	SEVERIN	35	<b>98379/63</b>	INTERFACE	132			
96182/82	RUNE	54	<b>98379/82</b>	INTERFACE	132			
96183/82	RUNE	54	<b>98380/05</b>	INTERFACE	140			
96184/05	ELTON	115	<b>98380/63</b>	INTERFACE	140			
96184/06	ELTON	115	<b>G94403/13</b>	MUSIC	16			
96186/05	IRVIN	87	<b>G94432A72</b>	LIGHT STR. MUSIC	126			
96186/06	IRVIN	87	<b>G96053/05</b>	MEDWAY	109			
96191/82	SIMONE	55	<b>G96053/63</b>	MEDWAY	109			
96192/82	RAMONA	55	<b>G96054/05</b>	TILBURY	112			
96193/05	SENSOR	118	<b>G96054/63</b>	TILBURY	112			
96193/06	SENSOR	118	<b>G96131/82</b>	BOLE	24			
96196/82	GERNA	50	<b>G96228/82</b>	ADONIA	26			
96197/82	BEAS	50	<b>G96229/82</b>	HANNI	52			
96233/22	MATTEO	46	<b>G96230/06</b>	HANNI	52			
96233/63	MATTEO	46	<b>G96230/82</b>	HANNI	52			
96240/22	CASPAR	47	<b>G96231/06</b>	TIBOR	122			
96242/63	MALMÖ	80	<b>G96232/06</b>	JANKO	122			
96243/63	MALMÖ	80	<b>G96232/22</b>	JANKO	122			
96260/05	INTERFACE	131	<b>G96239/06</b>	ARCHEA	13			
96261/05	INTERFACE	137	<b>G96244/63</b>	ORCO	10			

## Deutschland/Österreich/Schweiz

Brilliant AG  
Brillantstr. 1  
D-27438 Postfach 1109  
D-27442 Gnarrenburg  
Tel.: +49 (0) 47 63 89 0  
Fax: +49 (0) 47 63 89 171  
Internet: www.brilliant-ag.com  
info@brilliant-ag.com

## Italia

Brilliant AG Italia  
Strada 1, Palazzo F1,  
Milanofiori  
I - 20090 Assago (MI)  
Tel.: + 39 0 2 40 91 56 71  
Fax: + 39 0 2 40 91 75 50  
info@brilliant-ag.it

## België/Luxemburg

Brilliant Benelux  
12, rue Faidherbe  
3ème étage  
F - 59000 Lille  
Tel.: + 33 (0) 3 20 13 28 04  
Fax: + 33 (0) 3 20 55 75 09  
info@brilliant-ag.be

## Danmark

Brilliant Danmark  
Haarup Tvaervej 1  
8600 Silkeborg  
Tel.: + 45 97 47 26 95  
Fax: + 45 97 47 14 95  
info@brilliant-ag.dk

## España / Portugal

Brilliant Ibérica S.L.  
Pol. Ind. Más Blau I, Edificio Muntadas I  
Entrada A  
Carrer Bergueda 1  
Edificio Muntadas A  
08820 EL PRAT DE LLOBREGAT  
Tel.: +34 9 31 42 62 81  
info@brilliant-ag.es

## France

Service France  
Brillantstr. 1  
D-27438 Postfach 1109  
D-27442 Gnarrenburg  
Tel.: + 33 (0) 3 87 95 93 30  
+ 33 (0) 3 87 95 93 31  
Fax: + 33 (0) 3 87 95 93 32  
info@brilliant-ag.fr

## Great Britain

Poole Lighting Ltd.  
9 Cabot Lane  
Creekmore  
Poole  
Dorset  
BH23 3PE  
Tel.: + 44 (0) 120 269 7344  
info@poolelighting.com

## Hellas

Brilliant AG  
Brillantstr. 1  
D-27438 Postfach 1109  
D-27442 Gnarrenburg  
Tel.: +49 (0) 47 63 89 0  
Fax: +49 (0) 47 63 89 170  
Internet: www.brilliant-ag.com  
info@brilliant-ag.com

## Ireland

Peter Simmons  
Mobile.: +353 (0) 86 781 2852  
ireland@brilliant-ag.com

## Macedonia

AS Light  
Voin Drashkici 32  
1000 Skopje, R. Macedonia  
Tel./Fax: +389 (0) 2/3117 129  
Mobile: +389 (0) 75/245 728; 39 30 29  
macedonia@brilliant-ag.com

## Nederland

Brilliant Benelux  
12 rue Faidherbe  
3ème étage  
F-59000 Lille  
Tel.: +31 (0) 35 531 8208  
Fax: +31 (0) 35 533 0503  
info@brilliant-ag.nl

## Norge

Triolux AS  
Tel.: +47 38 18 58 80  
norge@brilliant-ag.com

## Polska

DeLighting Poland Spolka  
Z Ograniczona  
Odpowiedzialnoscia  
Psary Male,  
u. Budowlana 10  
62-300 Wrzesnia  
Tel.: +48 61 436 74 81  
Fax.: +48 60 777 34 94  
polska@brilliant-ag.com

## Rossija

OOO Brilliant RUS  
Ryvabinovaya St.55 bl.2  
121471 Moscow  
Tel./Fax: +7 (495) 443-2364  
Tel./Fax: +7 (495) 446-5934  
sale@brilliant-rus.ru  
www.brilliant-rus.ru

## Sverige

Brilliant Sweden  
Tel.: +46 8 559 22 535  
info@brilliant-ag.se

## Türkiye

Brilliant Aydınlatma İthalat İhracat  
ve Tic. Ltd. Şti.  
Mimar Sinan Mah, Cavaşbaşı Cad.  
Ayfer Sk. No:13 D:5  
Cekmeköy/Istanbul PK:34782  
Tel.: +90 216 640 17 93  
Fax.: +90 216 640 17 50  
info@brilliant.com.tr  
www.brilliant.com.tr

## U.A.E.

Brilliant Arabia  
Office Middle and Far East,  
North Africa  
Po Box 371027  
Dubai - UAE  
Tel.: +971 50 10 06 28 5  
Fax: +971 42395615  
Mobil: +971 50 10 06 28 5  
arabia@brilliant-ag.com

## Central Africa and Caribbean

FM Global  
Bareel 13  
9170 De Klinge  
Belgium  
Tel.: +32 476 912 108  
africa@brilliant-ag.com

## Česká Republika / Slovenská Republika

René Schmidt  
Jamnická 456  
Staré Město  
Frýdek-Místek  
CZ-738 01  
Tel.: +420 603 537 120  
Fax.: +420 226 013 302  
czech@brilliant-ag.com  
slovenska-republika@brilliant-ag.com

## Serbien, Bosnien und Herzogovina

LED Rasveta - Inženjering d.o.o.  
Bul. Muhajla Pupina 10d/20 n.p.  
11070 Novi Beograd  
Serbien  
Tel.: +381 11 311 31 93  
Fax: +381 11 314 83 39  
serbia@brilliant-ag.com  
www.vtac-ledrasveta.rs





A series of horizontal dotted lines spanning the width of the page, intended for taking notes.





**Brilliant AG**

Brilliantstr. 1 · D-27442 Gnarrenburg  
Tel.: +49 (0) 47 63 89 0 · Fax: +49 (0) 47 63 89 171  
international\_sales@brilliant-ag.com · www.brilliant-ag.com

92066/00



4 004353 268960