

 **TRIO**  
LIGHTING FOR YOU



2019





Catalogue 2019



TRIO übernimmt gegenüber Verbrauchern für alle Leuchten mit fest verbauten LEDs, die ab dem 01.04.2017 (Kaufdatum) gekauft wurden, eine freiwillige LED-Funktionsgarantie von 5 Jahren und für alle Leuchten mit fest verbauten LEDs, die vor dem 01.04.2017 gekauft wurden, eine freiwillige LED-Funktionsgarantie von 3 Jahren. Nähere Informationen hierzu finden Sie in der Garantieerklärung auf unserer Internetseite.  
[www.trio-leuchten.de](http://www.trio-leuchten.de)

TRIO takes on a voluntary LED functional warranty of 5 years to consumers of lamps with integrated LEDs bought on or after 01/04/2017 (purchase date), and 3 years for lamps with integrated LEDs bought before 01/04/2017. For further information, please visit our website.  
[www.trio-lighting.com](http://www.trio-lighting.com)

TRIO offre aux consommateurs une garantie volontaire de fonctionnement de 5 ans pour toutes les luminaires à LED intégrées achetées après le 01.04.2017 (date d'achat), et de 3 ans pour toutes les luminaires à LED intégrées achetées avant le 01.04.2017. Pour plus d'information, consultez notre site.  
[www.trio-lighting.com](http://www.trio-lighting.com)

TRIO verleent tegenover verbruikers voor alle armaturen met vast gemonteerde LED's die vanaf 01.04.2017 (aankoopdatum) werden gekocht, een vrijwillige LED-functiegarantie van 5 jaar en voor alle armaturen met vast gemonteerde LED's die voor 01.04.2017 werden gekocht, een vrijwillige LED-functiegarantie van 3 jaar. Voor meer informatie, consulteer onze website.  
[www.trio-lighting.com](http://www.trio-lighting.com)

TRIO ofrece a sus consumidores una garantía voluntaria de servicio de los LED de 5 años de duración para todas las lámparas con LED fijos adquiridas a partir del 01.04.2017 (fecha de compra) y de 3 años de duración para todas las lámparas con LED fijos adquiridas antes del 01.04.2017. Para más información, por favor visite nuestra página web.  
[www.trio-lighting.com](http://www.trio-lighting.com)

Ai consumatori, TRIO offre su tutti gli apparecchi sui quali sono montate sorgenti LED integrate, acquistate a partire dal 01/04/2017 (data di acquisto), una garanzia commerciale di funzionamento di 5 anni per gli apparecchi LED e su tutti gli apparecchi sui quali sono montate sorgenti LED integrate acquistate prima del 01/04/2017 una garanzia commerciale di funzionamento di 3 anni per gli apparecchi LED. Per ulteriori informazioni, vi preghiamo di visitare il nostro sito web.  
[www.trio-lighting.com](http://www.trio-lighting.com)

TRIO ofera consumatorilor o garantie comerciala de 5 ani, pentru toate corpurile de iluminat cu LED-uri incorporate, care au fost vândute începând cu 01.04.2017 (data achiziției), și pentru toate corpurile de iluminat cu LED-uri incorporate, care au fost vândute înainte de 01.04.2017, o garanție comercială de 3 ani pentru funcționarea LED-urilor. Pentru mai multe detalii, va rugăm să vizitați site-ul TRIO.  
[www.trio-lighting.com](http://www.trio-lighting.com)

TRIO myöntää kuluttajille vapaaehtoisen ledien toimivuustakuun. TRIO-valikoiman valaisimissa, joissa on kiinteästi asennetut ledit ja jotka on ostettu 1.4.2017 jälkeen (hankintapäivä), ledien takuu-aika on 5 vuotta. Valaisimissa, joissa on kiinteästi asennetut ledit ja jotka on ostettu ennen 1.4.2017, ledien takuu-aika on 3 vuotta. Lisätietoja verkkosivuiltamme.  
[www.trio-lighting.com](http://www.trio-lighting.com)

TRIO udziela konsumentom na wszystkie lampy z asortymentu TRIO z zamontowanymi na stałe diodami LED, które zakupione zostały od dnia 01.04.2017 r. (data zakupu), dobrowolnej gwarancji na działanie diod LED na okres 5 lat i na wszystkie lampy z zamontowanymi na stałe diodami LED, które zakupione zostały przed dniem 01.04.2017 r., dobrowolnej gwarancji na działanie diod LED na okres 3 lat. Na naszej stronie internetowej może Państwo uzyskać więcej informacji na ten temat.  
[www.trio-lighting.com](http://www.trio-lighting.com)

# Inhaltsverzeichnis

General Index · Index général · Algemene index · Índice general · Indice generale · Index general · Yleisindeksi · Ogólny indeks

Unternehmen · Company Entreprise · Onderneming · Empresa · Azienda · Compania · Yritys · Przedsiębiorstwo	4
Smarte Lichtsteuerung · smart lighting control contrôle d'éclairage intelligent · slimme lichtregeling · control de iluminación inteligente · controllo intelligente dell'illuminazione · control inteligent al iluminatului · älykäs valaistuksen ohjaus · Inteligentne sterowanie światłem	36
Leuchtenfamilien & Kombinationen · Families & coordinates Familles & coordonnés · Families & combinaties · Familias & coordinados · Famiglie & coordinati · Familii & Coordonate · Tuotepiheet & yhdistettävät tuotteet · Rodzinne orawy & kombinacje	56
Leuchten im Vintage Stil · Vintage style luminaires Luminaire style Vintage · Armaturen in Vintage stijl · Lámparas vintage · Apparecchi stile vintage · Corpur di iluminat vintage · Vintage valaisimet · Lampy w stylu vintage	232
Wand- und Deckenleuchten · Wall & Ceiling lamps Applique & plafonniers · Wandlampen & plafonnières · Apliques y plafones · Applique e plafoniere · Plafoniere si aplice · Seinä- & katto · Sufitowe i ścienne	262
Unterbauleuchten · Cabinet lighting Éclairage cuisine et dressing · Keuken- en kastverlichting · Iluminación de cocina y vestidor · Illuminazione cucina e spogliatoio · Iluminat pentru bucatarie si dressing room · Keittiö valaistus · Oprawy meblowe	384
Pendelleuchten & Kronen · Pendants & chandeliers Lustres & suspensions · Hanglampen & kroonluchters · Colgantes y Lámparas · Lampadari e sospensioni · Lustre si pendule · Riippu- & kruunu · Wiszące i żyrandole	390
Steh- und Tischleuchten · Table- & floor lamps Lampes de table & lampadaires · Tafel- & vloerlampen · Sobremesas y lámparas de pie · Lampade da tavolo e piantane · Veioze si lampadare · Pöytä- & lattia · Stołowe i podłogowe	444
Spotserien · Spots Spotterie · Spots · Focos · Faretti · Spoturi · Spotit · Reflektorki	516
Einbauleuchten · Recessed spots Spots encastrés · Inbouwspots · Focos empotrables · Faretti incasso · Spoturi incastrate · Uputetut spotit · Oprawy wbudowane	572
Badezimmerleuchten · Bathroom lighting Éclairage salle de bains · Badkamer verlichting · Iluminación de cuarto de baño · Illuminazione per bagno · Iluminat baie · Kylpyhuone valaistus · Oświetlenie łazienkowe	584
Leuchtmittel · Light sources Ampoules · Lichtbronnen · Fuentes de luz · Lampadine · Becuri · Valonlähteet · Źródła światła	602
Spezifikationen · Specifications Spécifications · Specificaties · Especificaciones · Specifiche · Specificații · Tekniset tiedot · Specyfikacje	620
Kontakt · Contact Contact · Contact · Contactar · Contatto · Contact · Yhteydenotto · Kontakt	662

# Unternehmen

Company · Entreprise · Onderneming · Empresa · Azienda · Compania · Yritys · Przedsiębiorstwo · Kurumsal

TRIO wurde im Jahr 1991 im sauerländischen Arnsberg gegründet. In mehr als 25 Jahren erfolgreicher Firmengeschichte hat sich unser Unternehmen als einer der führenden Spezialisten für dekorative Wohnraumbeleuchtung etabliert. Innovationskraft, ein hohes Maß an Flexibilität und ausgeprägte Kundennähe sind die Säulen unseres Erfolges.

Mit der Gründung von TRIO INTERNATIONAL im Jahr 2011 wurde der Grundstein für die Internationalisierung gelegt. Mittlerweile agieren wir in über 30 Ländern, dazu zählen Joint Ventures in Italien, Spanien, Skandinavien und auch in den USA.

Die TRIO Lighting Group beschäftigt heute rund 200 Mitarbeiter. Als modernes und zukunftsorientiertes Unternehmen bieten wir ausgezeichnete Produkte, überragenden Service und weitreichende Fachkompetenz, die nur einem Zweck dienen: den Kunden rundum zufrieden zu stellen.

TRIO was founded in Arnsberg, a town in Germany's Sauerland region, in 1991. In more than 25 years of successful company history, our company has established itself as one of the leading specialists in decorative home lighting. Innovation, a high degree of flexibility and enhanced customer proximity are the key reasons for our success.

The founding of TRIO INTERNATIONAL in 2011 laid the foundations for the international expansion. We meanwhile operate in more than 30 countries and have joint ventures in, for example, Italy, Spain, Scandinavia and in the USA.

TRIO Lighting Group currently has more than 190 employees. As a modern and future-oriented company, we offer excellent products, outstanding service and extensive know-how that serve only one purpose, namely to completely satisfy our customers.

TRIO werd opgericht in het jaar 1991 in Arnsberg in het Sauerland. Tijdens een succesvolle bedrijfsgeschiedenis meer dan 25 jaar heeft onze onderneming zich gevestigd als één van de toonaangevende specialisten voor decoratieve woningverlichting. Innovatievermogen, maximale flexibiliteit en uitgesproken klantennabijheid zijn de zuilen van ons succes.

Door de oprichting van TRIO INTERNATIONAL in het jaar 2011 werd de basis gelegd voor de internationalisering. Ondertussen ageren wij in meer dan 30 landen, daarbij horen joint ventures in Italië, Spanje, Scandinavië en in de VS.

De TRIO Lighting Group telt momenteel in totaal meer dan 200 medewerkers. Als moderne en toekomstgerichte onderneming bieden wij uitstekende producten, buitengewone service en uitgebreide vakbekwaamheid met slechts één doel voor ogen: een geheel tevreden klant.

TRIO fue fundada en el año 1991 en Arnsberg, en la región alemana de Sauerland. En mas de 25 años de éxito en la historia de la empresa, esta se ha establecido como uno de los especialistas líderes en iluminación decorativa para el hogar. Fuerza innovadora, una gran flexibilidad y una marcada cercanía al cliente son los pilares de nuestro éxito.

Con la fundación de TRIO INTERNATIONAL en el año 2011, se puso la primera piedra para la internacionalización. Desde entonces, estamos activos ya en más de 30 países, incluyendo empresas conjuntas en Italia, España, Escandinavia y también los EE. UU.

El grupo TRIO Lighting da empleo en la actualidad a un total aproximado de mas de 200 empleados. Como empresa moderna y orientada al futuro, ofrecemos productos extraordinarios, una asistencia excelente y una amplia competencia técnica, todo esto al servicio de un solo fin: la satisfacción general de los clientes.

TRIO a été fondée en 1991 à Arnsberg dans le Sauerland. Riche de plus de 25 ans d'existence fructueuse, notre entreprise s'est imposée comme l'un des leaders spécialisés dans l'éclairage d'intérieur décoratif. Notre force d'innovation, notre très grande flexibilité et notre grande proximité avec les clients constituent les piliers de notre succès.

La création de TRIO INTERNATIONAL en 2011 a posé les fondations de notre internationalisation. Depuis, nous sommes présents dans plus de 30 pays, avec des coentreprises en Italie, en Espagne, en Scandinavie mais également aux États-Unis.

Au total, le groupe TRIO Lighting emploie aujourd'hui plus de 200 collaborateurs. En tant qu'entreprise moderne et tournée vers l'avenir, nous proposons d'excellents produits et services ainsi que de nombreuses compétences spécialisées employées dans un seul but : pleinement satisfaire le client.

TRIO fu fondata nel 1991 ad Arnsberg, nella regione della Renania Settentrionale-Vestfalia in Germania. In piu di 25 anni di successo l'azienda ha guadagnato una posizione tra i produttori leader di illuminazione decorativa domestica. Forza innovativa, elevata flessibilità e spiccato orientamento al cliente sono i pilastri del nostro successo.

Con la fondazione di TRIO INTERNATIONAL nel 2011, l'azienda ha compiuto il primo passo verso l'internazionalizzazione. La nostra presenza si registra ormai in 30 paesi, anche sotto forma di Joint Venture in Italia, Spagna, Scandinavia e anche negli USA.

Il TRIO Lighting Group conta ad oggi complessivamente piu di 190 dipendenti. La nostra azienda moderna e proiettata verso il futuro offre prodotti d'eccellenza, un servizio impeccabile ed estese competenze nel settore con un unico obiettivo: la soddisfazione del cliente.

TRIO a fost înființată în anul 1991 în orașul Arnsberg din regiunea Sauerland. În istoria de succes a firmei care se întinde pe durata a mai mult de 25 de ani, compania noastră s-a definit ca fiind unul din liderii specialiștilor pentru iluminatul decorativ al locuințelor. Forța de inovație, un mare grad de flexibilitate și apropierea intensă de client sunt piloanele succesului nostru.

Prin înființarea TRIO INTERNATIONAL în anul 2011 a fost pusă piatra de temelie pentru globalizare. Între timp acționăm în peste 30 de țări, printre acestea se numără societăți mixte din Italia, Spania, Scandinavia și SUA.

TRIO Lighting Group are astăzi mai mult de 200 angajați. În calitate de companie modernă și orientată spre viitor oferim produse excelente, service performant și competență vastă de specialitate, toate acestea servind unui singur scop: clienți pe deplin mulțumiți din toate punctele de vedere.

TRIO perustettiin vuonna 1991 Keski-Saksan Arnsbergissä. Yrityksen ensimmäinen neljännesvuosisata on ollut menestyksellä, ja se on kohonnut johtavien kodin sisustusvalaistuksen asiantuntijoiden joukkoon. Innovatiivisuus, joustavuus ja asiakaslähtöisyys ovat yrityksen menestyksen tärkeimpiä kulmakiviä.

TRIO INTERNATIONAL -yhtiön perustamisen myötä vuonna 2011 yritys lähti kansainvälisille urille. Tällä hetkellä se toimii yli 30 maassa, ja yhteisyrityksiä on perustettu Italiaan, Espanjaan, Pohjoismaihin ja Yhdysvaltoihin.

TRIO Lighting Groupin palveluksessa on yli 200 henkilöä. Nykyaikainen ja tulevaisuuteen katsova yritys valmistaa laajan asiantuntemuksensa turvin ensiluokkaisia tuotteita ja tarjoaa tyytyväisille asiakkailleen ylivertaista palvelua.

Firma TRIO powstała w 1991 roku w miejscowości Arnsberg w Sauerland. Ponad 25 lat pełnej sukcesów historii przedsiębiorstwa stało się ono jednym z głównych ekspertów w zakresie dekoracyjnego oświetlenia pomieszczeń mieszkalnych. Innowacyjność, duża wszechstronność oraz bliski kontakt z klientem to filary naszego sukcesu.

Utworzenie przedsiębiorstwa TRIO INTERNATIONAL w 2011 roku stanowiło podwaliny międzynarodowego zasięgu działalności. Dziś jesteśmy obecni w ponad 30 krajach, tworząc spółki joint venture we Włoszech, Hiszpanii, Skandynawii i w USA.

TRIO Lighting Group zatrudnia obecnie około 200 pracowników. Jako nowoczesne i ukierunkowane na przyszłość przedsiębiorstwo oferujemy znakomite produkty, wyjątkową obsługę i szerokie kompetencje specjalistyczne służące tylko jednemu celowi: zadowoleniu klienta.



# Serienübersicht

Family overview · Aperçu par famille · Overzicht per familie · Vista general por familia ·  
Panoramica per famiglia · Prezentare pe familii de produse · Perheen yleiskuvaus ·  
Przegląd rodziny · Ürün Ailesi

<b>ABERDEEN</b>	365	<b>BRONCO</b>	425	<b>CONDUS</b>	600	<b>DUKE</b>	114	<b>HENK</b>	508
<b>ADRIAN</b>	328	<b>BULTO</b>	329	<b>CONGRESS</b>	294	<b>DYLAN</b>	590	<b>HIGHWAY</b>	308
<b>ADRIANO</b>	362	<b>BUSA</b>	334	<b>CONO</b>	378	<b>ECCO</b>	389	<b>HOKKAIDO</b>	270
<b>AGENTO</b>	200	<b>BUTTELLO</b>	593	<b>CONTENDER</b>	295	<b>EDDA</b>	251	<b>HOOD</b>	230
<b>AKURA</b>	280	<b>CALAIS</b>	423	<b>CONTRAST</b>	293	<b>EDISON</b>	164	<b>HOSTEL</b>	228
<b>ALABASTER</b>	348	<b>CALCIO</b>	110	<b>CONVERTER</b>	295	<b>EDISON II</b>	433	<b>HOTEL</b>	216
<b>ALBA</b>	333	<b>CALGARY</b>	468	<b>CORD</b>	238	<b>EDWARD</b>	178	<b>HOUSTON</b>	570
<b>ALEGRO</b>	100	<b>CALVARO</b>	405	<b>CORLAND</b>	96	<b>ELINA</b>	104	<b>HUGO</b>	596
<b>ALINO</b>	387	<b>CAMPO</b>	378	<b>CORLAND II</b>	398	<b>ELSA</b>	247	<b>HYDRA</b>	300
<b>ALVARO</b>	322	<b>CANDELA</b>	426	<b>CORMINT</b>	332	<b>EMBASSY</b>	352	<b>ICARO</b>	488
<b>AMSTERDAM</b>	493	<b>CANNES II</b>	449	<b>CORONADO</b>	97	<b>EMERALD</b>	504	<b>IMARA</b>	44
<b>ANDREUS</b>	220	<b>CAPITAL</b>	165	<b>CORTEZ</b>	430	<b>ENRICO</b>	364	<b>INDIRA</b>	305
<b>ANTONIO</b>	314	<b>CARBONADO</b>	331	<b>COSINUS</b>	222	<b>ESCALATE</b>	363	<b>JACOB</b>	257
<b>ANTWERP</b>	460	<b>CARICO</b>	550	<b>CRISTALINA</b>	325	<b>ESPEJO</b>	330	<b>JANA</b>	260
<b>APART</b>	601	<b>CASCO</b>	477	<b>CRISTO</b>	506	<b>EVA</b>	408	<b>JANKO</b>	242
<b>ARAGON</b>	387	<b>CATOKI</b>	98	<b>CROSS</b>	174	<b>FACELLA</b>	378	<b>JASMIN</b>	261
<b>ARANGO</b>	479	<b>CATOKI II</b>	309	<b>CUADRO</b>	372	<b>FACETTE</b>	324	<b>JASPER</b>	186
<b>ARBUSTOS</b>	128	<b>CAVALLO</b>	401	<b>CUBA</b>	518	<b>FARO</b>	136	<b>JOEL</b>	326
<b>ARIZONA</b>	478	<b>CAYMAN</b>	520	<b>CUBE</b>	364	<b>FILIGRAN</b>	489	<b>JOHANN</b>	256
<b>ARKO</b>	496	<b>CENTO</b>	319	<b>CUBO</b>	599	<b>FISHERMAN</b>	246	<b>JONES</b>	558
<b>ARY</b>	510	<b>CESAR</b>	317	<b>CUMANO</b>	291	<b>FLESSO</b>	593	<b>JOOST</b>	509
<b>ASTRID</b>	250	<b>CHARLY</b>	44	<b>CURTIS</b>	374	<b>FLEXO</b>	503	<b>JUDITH</b>	253
<b>AURORA</b>	342	<b>CHERRY</b>	512	<b>CURVA</b>	336	<b>FLORESTAN</b>	469	<b>JURA</b>	574
<b>AURORA II</b>	480	<b>CHIARA</b>	428	<b>DAKOTA</b>	176	<b>FLORIS</b>	330	<b>KANNAN</b>	420
<b>AVIGNON</b>	540	<b>CHIBA</b>	286	<b>DAMIAN</b>	52	<b>FRED</b>	382	<b>KAZAN</b>	108
<b>AZUR</b>	60	<b>CHICO</b>	335	<b>DARCO</b>	362	<b>FREDDY</b>	556	<b>KINGSTON</b>	142
<b>BAJO</b>	439	<b>CHIROS</b>	344	<b>DAVI</b>	510	<b>FRIEDA</b>	258	<b>KOBE</b>	271
<b>BALLOON</b>	118	<b>CHRIS</b>	122	<b>DAXTER</b>	562	<b>FUTURE</b>	269	<b>KOLIAN</b>	594
<b>BALOUBET</b>	544	<b>CHRISTOBAL</b>	160	<b>DAYTONA</b>	512	<b>FYNN</b>	509	<b>KOLIBRI</b>	501
<b>BARON</b>	182	<b>CISCO</b>	302	<b>DENVER</b>	370	<b>GARDA</b>	226	<b>KYOTO</b>	287
<b>BASIC</b>	541	<b>CLAIRE</b>	350	<b>DIAMO</b>	46	<b>GEMINI</b>	50	<b>LACAL</b>	76
<b>BERGAMO</b>	482	<b>CLAPTON</b>	522	<b>DICE</b>	62	<b>GEMMA</b>	325	<b>LACAN</b>	511
<b>BERLIN</b>	505	<b>CLARIMO</b>	600	<b>DIEGO</b>	440	<b>GENT</b>	457	<b>LACAPO</b>	359
<b>BIRTE</b>	248	<b>CLASSY</b>	192	<b>DISC</b>	337	<b>GERRIT</b>	508	<b>LAGOS</b>	530
<b>BODRUM</b>	310	<b>CLEO</b>	342	<b>DISCALGO</b>	168	<b>GESTIC</b>	74	<b>LANA</b>	334
<b>BOLERO</b>	358	<b>COLIN</b>	437	<b>DIVO</b>	381	<b>GINELLI</b>	154	<b>LAON</b>	382
<b>BOLOU</b>	546	<b>COLUMBUS</b>	78	<b>DOLPHIN</b>	341	<b>GONZALO</b>	327	<b>LARA</b>	254
<b>BOLSA</b>	588	<b>COMPO</b>	598	<b>DONNA</b>	504	<b>GOTHAM</b>	234	<b>LEICESTER</b>	106
<b>BOOLAN</b>	424	<b>COMTESS</b>	321	<b>DOUGLAS</b>	126	<b>GRANDE</b>	495	<b>LENTIL</b>	116
<b>BOSTON</b>	413	<b>CONCORDE</b>	294	<b>DOVER</b>	422	<b>HAMILTON</b>	153	<b>LEVISTO</b>	552
<b>BOWIE</b>	568	<b>CONCRETE</b>	560	<b>DRAGON</b>	297	<b>HAVANNA</b>	526	<b>LIÈGE</b>	458
<b>BRIAN</b>	587	<b>CONDOR</b>	293	<b>DROPS</b>	400	<b>HELEN</b>	589	<b>LIGARA</b>	382



LINDA	252	MONTREAL	407	PINDOS	583	SAPPORO	290	TORRANCE	264
LINZ	456	MORRISON	569	PLATON	371	SATURN	395	TOULON	150
LISBOA	414	MORTEN	506	POLLY	500	SAVANNAH	512	TOYAMA	280
LIVARO	48	MOSAIQUE	152	POLO	494	SEDONA	298	TRADITIO	194
LOOP	80	NABAB	421	POLYDOR	312	SENATOR	406	TRIPOLIS	231
LOPEZ	477	NACHO	170	PONTIUS	538	SETA	510	TRISTAN	54
LORELEY	180	NAGANO	284	PORTO	140	SEVILLA	99	TRUMPET	156
LORIS	494	NALIDA	42	PORTOFINO	84	SHANGHAI	466	TUCSON	58
LOTUS	278	NANDO	599	PRETO	500	SHAOLIN	292	TURNER	296
LOUIS	361	NANDOR	454	PRIMO	335	SHARK	536	VALERIO	370
LUCAS	268	NAPOLI	190	PRONTO	503	SHOGUN	289	VANCOUVER	346
LUCIA	333	NARCOS	532	PYRAMID	315	SIGNA	162	VAPORE	130
LUGANO	202	NASHVILLE	304	QUEBEC	473	SILAS	72	VARESE	446
LUIGI	354	NESTOR	452	QUIDAM	484	SIMEO	385	VARIO	497
LUIS	511	NEVIO	586	QUINTA	351	SLASH	420	VEGAS	188
LUPO	498	NICOLAS	322	RADO	491	SNAKE	306	VENTURA	507
LYON	212	NIKOSIA	158	RAMIRO	409	SOLA	465	VERONA	483
MACAU	392	NILO	594	RAMON	388	SPIRELLI	163	VICTORIA	432
MADEIRA	132	NO.5	236	RAY	591	SPLIT	474	VIEW	592
MAMBA	377	NORA	334	REMUS	404	STAKKATO	399	VIOLA	437
MARCOS	268	OLIVIA	381	RENNES	541	STALYPSO	323	VISION	528
MARIO	354	OLYMPUS	82	REPOSA	338	STAMINA	434	VITA	380
MARIUS	94	ONTARIO	144	RILA	576	SUBARA	274	WALES	365
MARLEY	564	ONYX	410	RODDIK	416	SUZUKA	276	WIM	515
MARLON	376	OPIUM	68	RODERIC	492	SWAN	494	XAVI	596
MARRIOT	356	OREGON	293	RODNEY	184	SWEETY	166	YOKOHAMA	292
MARTA	381	ORLANDO	513	ROMADOUR	323	SYDNEY	92	ZAGROS	580
MATS	514	OSAKA	282	ROMINO II	408	TAJO	502	ZENIT	343
MATTIMO	597	OTTAWA	412	ROMULUS	402	TAKESHI	281	ZEUS	318
MELBY	43	PACCO	324	ROTARIO	360	TANJA	255	ZIDANE	524
MERAN	208	PAGENO	324	ROTIN	244	TENTO	112	ZITA	366
MESSINA	88	PALO	486	RUSTICA	196	TEXEL	459	ZORRO	368
MIAMI	490	PALO II	487	SALIM	462	THUNDER	124	ZUCCA	441
MICHAEL	566	PAMIR	578	SALINA	90	TILL	510		
MICHIGAN	470	PAPER	442	SALINERO	394	TIMBER	240		
MIDAS	148	PARIS II	450	SAM	599	TIRIAC	64		
MIKO	285	PENTA	320	SAMBO	303	TITUS	272		
MILANO	348	PEREZ	464	SAMURAI	289	TOKYO	288		
MINSK	429	PHOENIX	266	SANDRO	66	TOLEDO	286		
MIRO	380	PIET	515	SANNA	255	TORCIA	379		
MONTENDER	436	PILATUS	538	SANTO	476	TORINO	313		
MONTI	506	PILLAR	475	SANTO II	478	TORNESH	198		

# Pendelleuchten & Kronen

Pendants & chandeliers · Lustres & suspensions · Hanglampen & kroonluchters · Colgantes y Lámparas · Lampadari e sospensioni · Lustre si pendule · Riippu- & kruunu · Wiszące i żyrandole · Avize & Sarkıtlar



MADEIRA 132



PORTO 140



FARO 137



ONTARIO 144



ONTARIO 146



ONTARIO 146



VAPORE 130



CALAIS 423



DOVER 422



MIDAS 148



MOSAIQUE 152



HAMILTON 153



BARON 182



LISBOA 414



VEGAS 188



OTTAWA 412



BOSTON 413



JASPER 187



NABAB 421



BALLOON 118



CHRIS 120



THUNDER 124



ARBUSTOS 128



DOUGLAS 127



RAMIRO 409



MONTREAL 407



ROMINO II 408



HOUSTON 408



EVA 408



DISCALGO 168



EDWARD 179



DAKOTA 177



NACHO 170



CANDELA 426



BOOLAN 424



CROSS 174



MINSK 429



NAPOLI 190



CLASSY 192



TRADITIO 194



RUSTICA 197



KINGSTON 142



TOULON 150



SLASH 420



KANNAN 420



BRONCO 425



ONYX 410



# BARON

# Pendelleuchten & Kronen

Pendants & chandeliers · Lustres & suspensions · Hanglampen & kroonluchters · Colgantes y Lámparas · Lampadari e sospensioni · Lustre si pendule · Riippu- & kruunu · Wiszące i żyrandole · Avize & Sarkitlar



LUGANO 202



GARDA 225



HOTEL 214



HOTEL 215



HOSTEL 229



ANDREUS 220



LORELEY 180



CHIARA 428



ROTIN 244



CORTEZ 430



GOTHAM 234



CORD 238



TIMBER 241



JOHANN 256



SANNA 255



TANJA 255



JUDITH 253



ASTRID 250



ELSA 247



BIRTE 248



BIRTE 249



CHRISTOBAL 161



SIGNA 162



SPIRELLI 163



NIKOSIA 159



TRUMPET 157



EDISON 164



VIOLA 437



COLIN 437



MONTENDER 436



CARBONADO 440



DIEGO 440



SWEETY 166



CAPITAL 165



BAJO 439



LACAN 438



ZUCCA 441



RODNEY 184



RODDIK 416



TRIPOLIS 231



HOOD 230



COSINUS 222



MERAN 210



JACOB 257



FRIEDA 258



FISHERMAN 246



EDDA 251



JASMIN 261



EDISON II 433



DAMIAN 52



TRISTAN 54



DROPS 400



GINELLI 155



VICTORIA 432



PAPER 442

# Pendelleuchten & Kronen

Pendants & chandeliers · Lustres & suspensions · Hanglampen & kroonluchters · Colgantes y Lámparas · Lampadari e sospensioni · Lustre si pendule · Riippu- & kruunu · Wiszące i żyrandole · Avize & Sarkıtlar



MACAU 392



SATURN 395



OLYMPUS 83



SYDNEY 92

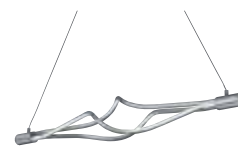

LOOP 81



STAKKATO 399



AZUR 61

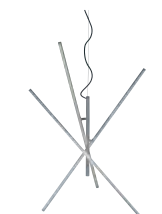

TIRIAC 64



TUCSON 58



DICE 62

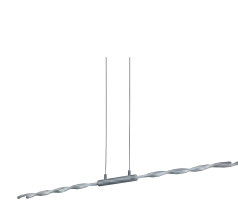

PORTOFINO 85

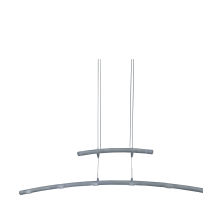

COLUMBUS 78



LACAL 76



GESTIC 75



CALVARO 405



SALINERO 394



SILAS 72



LIVARO 48



AGENTO 200



ALEGRO 100



ELINA 104



SEVILLA 99



SANDRO 67



ROMULUS 402

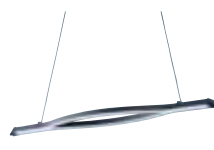

REMUS 404



DUKE 115

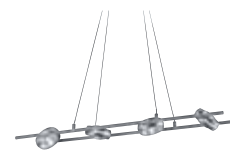

LEICESTER 107

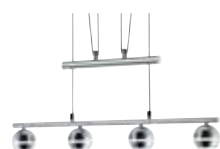

BALOUBET 545

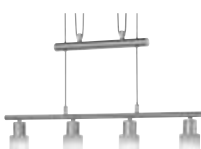

JONES 558



FREDDY 556



LEVISTO 555

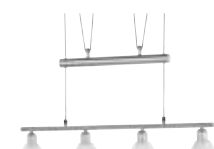

STAMINA 434

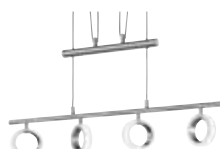

CORLAND II 398



SENATOR 406



CARICO 551

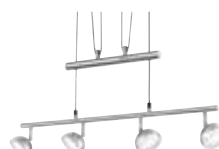

BOLOU 546



SALINA 90



MESSINA 89



MARIUS 95

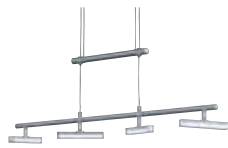

OPIUM 69



CAVALLO 401



LENTIL 116



CORONADO 97



# MACAU

# Deckenleuchten

Ceiling lamps · Plafonniers · Plafonnières · Plafones ·  
Plafoniere · Plafoniere · Kattvalaisimet · Plafony · Plafonyer



DOLPHIN 341



ZENIT 343



VANCOUVER 346



COMTESS 321



MILANO 348



ALABASTER 348



FARO 136



VAPORE 130



EDWARD 178



DAKOTA 176



BARON 182

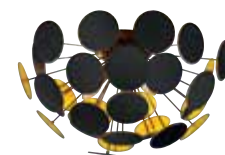

DISCALGO 168



REPOSA 338



NAPOLI 190



RUSTICA 196



QUINTA 351

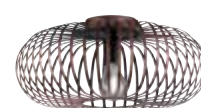

JOHANN 256



NACHO 170



ARBUSTOS 128



DOUGLAS 126



SALINA 90



MESSINA 88

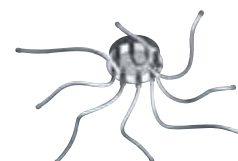

PORTOFINO 86



POLYDOR 312



SEDONA 298

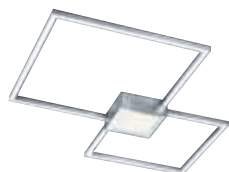

HYDRA 300



CISCO 302

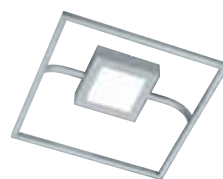

SAMBO 303



DRAGON 297

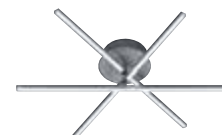

HIGHWAY 308



TUCSON 58

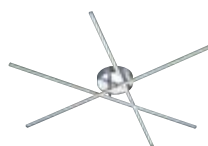

TIRIAC 64



INDIRA 305

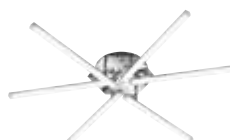

SANDRO 66



BODRUM 310



TURNER 296



VISION 529



CARICO 551



BALOUBET 544



LENTIL 116



CLAPTON 523



JONES 558





ONTARIO 349



MOSAIQUE 152

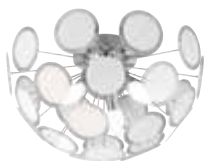

DISC 337



CLAIRE 350



VEGAS 188



CROSS 174



TRADITIO 194



OLYMPUS 82



CHRIS 122



CORONADO 97



SYDNEY 92



CORLAND 96

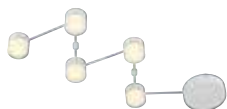

NASHVILLE 304



CURVA 336



GINELLI 154



# DOLPHIN

# Deckenleuchten

Ceiling lamps · Plafonniers · Plafonnières · Plafones ·  
Plafoniere · Plafoniere · Kattvalaisimet · Plafony · Plafonyer



SUBARA 274



SUZUKA 276



TORRANCE 264



TITUS 272



HOKKAIDO 270



KOBE 271



PHOENIX 266



OSAKA 282



LOTUS 278



AKURA 280



TOYAMA 280



TAKESHI 281



FUTURE 269



LUCAS 268



MARCOS 268



CHARLY 44



NALIDA 42



CHIBA 286



CONGRESS 294



CONCORDE 294



SHAOLIN 292



SAPPORO 290



SAMURAI 289



SHOGUN 289



OREGON 293



CONTRAST 293



CONDOR 293



CONVERTER 295



CONTENDER 295



ZEUS 318



JOEL 326



ALVARO 322



NICOLAS 322



GEMMA 325



ROMADOUR 323



STALYPSO 323



MELBY 43



CATOKI 98

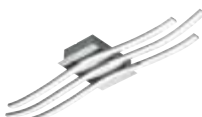

CATOKI 98



CATOKI II 309



SILAS 72



ROMULUS 402



TOKYO 288



KYOTO 288



YOKOHAMA 292



MIKO 285



CUMANO 291



KYOTO 287



IMARA 44



CESAR 317



CESAR 316



CENTO 319



GONZALO 327



FACETTE 324



CRISTALINA 325



PENTA 320



TOLEDO 286



LIVARO 48



SUBARA

# Deckenleuchten

Ceiling lamps · Plafonniers · Plafonnières · Plafones ·  
Plafoniere · Plafoniere · Kattvalaisimet · Plafony · Plafonyer



LUGANO 204



DIAMO 46



EMBASSY 352



HOTEL 216



HOSTEL 228



AGENTO 200



GARDA 226



MERAN 210



GARDA 224



OPIUM 70



HAVANNA 556



ANTONIO 314



TORINO 313



CHIOS 344

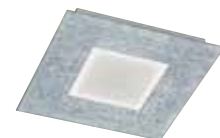

CHIOS 345



NIKOSIA 158



CHRISTOBAL 160



SIGNA 162



SPIRELLI 163



PYRAMID 315

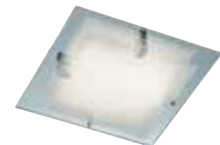

ESPEJO 330



LUCIA 333



ALBA 333



CORMINT 332



ADRIAN 328



BULTO 329

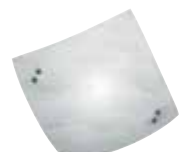

BUSA 334



VICTORIA 432



CARBONADO 331



FLORIS 330



NORA 334



LANA 334



SWEETY 166



BOLSA 588



CUBO 599



DYLAN 590



NEVIO 586



NANDO 599



CONDUS 600



CUBE 364



PACCO 324



PAGENO 324



PRIMO 335



CHICO 335



APART 601



CLARIMO 600



SAM 599

# LUGANO



# Wandleuchten

Wall lamps · Appliques · Wandlampen · Appliques · Appliques ·  
Lămpi de perete · Seinävalaisimet · Scienne · Duvar aydınlatma



MADEIRA 133



MARRIOT 356



LOUIS 361



BOLERO 358



ANDREUS 220

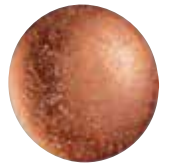

CHIOS 344



EDWARD 178



LYON 212



MERAN 211



KAZAN 108



TENTO 112

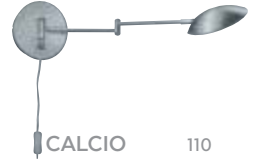

CALCIO 110



CURTIS 374



CUADRO 372



ZORRO 368



DARCO 362



ABERDEEN 365



ADRIANO 362



ESCALATE 363



LACAPO 359



DENVER 370



ROTARIO 360



ENRICO 364



CUBE 364



NACHO 170



NAPOLI 190



CLASSY 192



FRIEDA 258



TRADITIO 194



CAMPO 378



FACELLA 378



CONO 378



ZITA 366



TORNESH 198



TORCIA 379

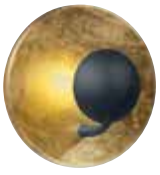

AURORA 342



HOTEL 218



LUGANO 204



WALES 365



LEICESTER 106



LENTIL 117



GOTHAM 234



# MADEIRA

# Wandleuchten

Wall lamps · Appliques · Wandlampen · Appliques · Appliques ·  
Lămpi de perete · Seinävalaisimet · Scienne · Duvar aydınlatma



SUBARA 274



SALINA 91

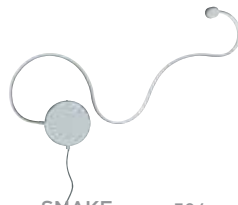

SNAKE 306



HYDRA 300



MARIUS 94



SANDRO 66



MARIO 354



LUIGI 354



CAPITAL 165



MAMBA 377



OLYMPUS 82



PLATON 371



VALERIO 370



ANTONIO 314



TOULON 150



TRISTAN 54



SPIRELLI 163



NIKOSIA 158



CHRISTOBAL 161



SIGNA 162



MIRO 380



CORMINT 332



SWEETY 166



BRIAN 587



HELEN 589



BOLSA 586



RAY 591



MATTIMO 597



KOLIAN 594



NILO 594



BUTTELLO 593



XAVI 596



FLESSO 593



SIMEO 385



ARAGON 387



ALINO 387



RAMON 388

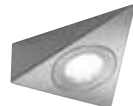

ECCO 389





PORTOFINO 84



VITA 380



OLIVIA 381



DIVO 381



MARTA 381



CARBONADO 331



DYLAN 590



NEVIO 586



HUGO 596



VIEW 592



# MARIO

# Spotserien

Spots · Spotterie · Spots · Focos · Faretti · Spoturi · Spotit · Reflektorki · Spotlar



CUBA 518

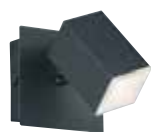

LAGOS 530



GEMINI 50



DAKOTA 176



HOUSTON 570



DUKE 114



SHARK 536



HAVANNA 526



CLAPTON 522



OPIUM 70



ZIDANE 524



MARLEY 564



CAYMAN 520

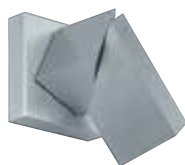

DAXTER 562



TRUMPET 156



TIMBER 240



CONCRETE 560



BALOUBET 544

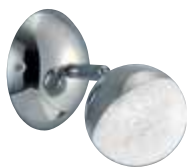

CHRIS 122



BOWIE 568



CARICO 550



JONES 558



LEVISTO 552



FREDDY 556



MORRISON 569



MICHAEL 566



MARLON 376



LEVISTO 383



LAON 382



PINDOS 583



ZAGROS 581



ZAGROS 581



PAMIR 579



PAMIR 579



RILA 577



JURA 575



JURA 575



COMPO 598



NARCOS 532



VISION 528



BOLOU 546



GINELLI 254



FRED 382



LIGARA 382



RILA 577



CUBA

# Tischleuchten

Table lamps · Lampes de table · Tafellampen · Sobremesas ·  
Lampa da tavolo · Veioze · Pöytävalaisimet · Lampy stołowe · Masa lambaları



LUGANO 202



AGENTO 200



CANNES II 449



LYON 212



PARIS II 450



MERAN 208



HOTEL 216



LORELEY 180



ANDREUS 220



WIM 515



MATS 514



PIET 515



COSINUS 223



HOOD 230



GARDA 224



ORLANDO 512



DAYTONA 512



CHERRY 512



TEXEL 459



LIÈGE 458



EVA 408



ANTWERP 460



DICE 62



NACHO 172



THUNDER 124



ARBUSTOS 128



CAPITAL 165



LACAN 511



JANKO 242



TIMBER 240



ROTIN 244



GOTHAM 234



NO. 5 236



ASTRID 250



LARA 254



JANA 260



JASMIN 261



LINDA 252



JACOB 257

# CANNES II



# Tischleuchten

Table lamps · Lampes de table · Tafellampen · Sobremesas ·  
Lampa da tavolo · Veioze · Pöytävalaisimet · Lampy stołowe · Masa lambaları



VAPORE 131



FARO 137



PORTO 140

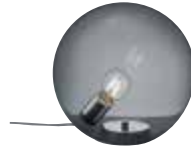

MIDAS 148



MOSAIQUE 152



DAMIAN 52



EDISON 164



JOOST 509



VENTURA 507



LUIS 511



SETA 510



ARY 510



SALINA 91



LOOP 80



SYDNEY 92



OLYMPUS 82



CATOKI 98



AZUR 60



ALEGRO 100



AURORA II 480



MICHIGAN 470



BERGAMO 482



TENTO 113



KAZAN 108



AMSTERDAM 493



MIAMI 490



POLO 494



GRANDE 495



SWAN 494



LORIS 494



CALCIO 110



KOLIBRI 501



PRETO 500



ARKO 496



DUKE 114



NARCOS 533



FILIGRAN 489



PALO 486



PALO II 487



BOLOU 547



BALOUBET 545



CHRIS 122



KINGSTON 142



HENK 508



DONNA 504



BERLIN 505



EMERALD 504



FYNN 509



MONTI 506



TILL 510



DAVI 510



CRISTO 506



MORTEN 506



OPIUM 68



LACAL 76



SEVILLA 99



MARIUS 94



CATOKI 98



PORTOFINO 84



RODERIC 492



RADO 491



POLLY 500



LUPO 498



VARIO 497



SHARK 537



CONCRETE 560



TRUMPET 156



FREDDY 557



JASPER 186



TAJO 502



PRONTO 503



FLEXO 503

# Stehleuchten

Floor lamps · Lampadaires · Vloerlampen · Lámparas de pie ·  
Piantane · Lampadare · Lattiavalaisimet · Lampy podłogowe · Lambaderler



VAPORE 131



VARESE 446



CANNES II 449



PARIS II 450



LYON 212



COSINUS 222



NESTOR 452



NANDOR 454



HOSTEL 228



ANDREUS 220



LINZ 456



GENT 457



TRIPOLIS 231



GENT 457



LIÈGE 458



ANTWERP 460



NO. 5 236



TEXEL 459



CROSS 174



NACHO 172



EDISON 164



TORNESH 198



HOOD 230





LUGANO 202



MERAN 208



HOTEL 215



PEREZ 464



GOTHAM 234



ROTIN 244



JANKO 242



SALIM 462



LYON

# Stehleuchten

Floor lamps · Lampadaires · Vloerlampen · Lámparas de pie ·  
Piantane · Lampadare · Lattiavalaisimet · Lampy podłogowe · Lambaderler



MICHIGAN 470



QUEBEC 473



CALGARY 468



ELINA 105



SPLIT 474



SANTO II 478



CHRIS 120



BALLOON 118



CHRIS 120



SALINA 91



LOOP 80



MESSINA 88



AZUR 60



TUCSON 59



SILAS 72



LACAL 76



SEVILLA 90



PILLAR 475

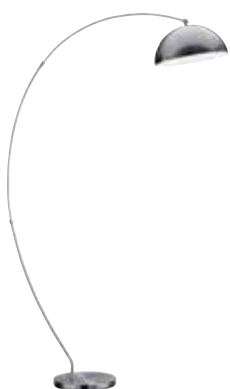

FLORESTAN 469



SOLA 465



COLUMBUS 79

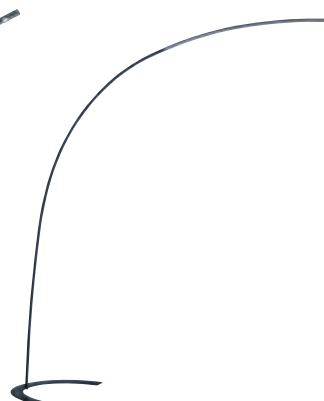

SHANGHAI 466



TIMBER 240



JASPER 186



CASCO 477



ARANGO 479



SANTO 476

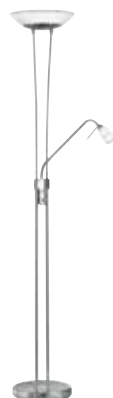

LOPEZ 477



ARIZONA 478



RUSTICA 196



SYDNEY 92



OLYMPUS 82



PORTOFINO 84



MARIUS 94



ARBUSTOS 129



ALEGRO 100



ELINA 102



ICARO 488



TRUMPET 156



FILIGRAN 489



PALO II 487



PALO 486

# Stehleuchten

Floor lamps · Lampadaires · Vloerlampen · Lámparas de pie ·  
Piantane · Lampadare · Lattiavalaisimet · Lampy podłogowe · Lambaderler



KAZAN 108

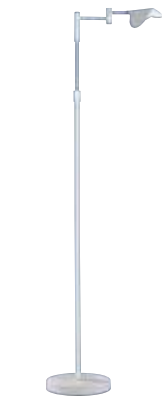

TENTO 112

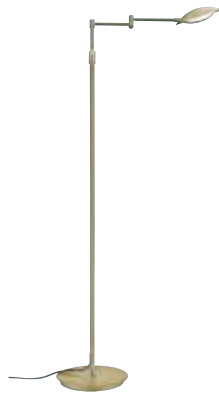

CALCIO 110



BERGAMO 482



GESTIC 74



AURORA II 480



EDWARD 178



DAKOTA 176



DUKE 114



NARCOS 533



ZIDANE 488



CORLAND 96



OPIUM 68



CONCRETE 560



LAGOS 530



SHARK 537



LEICESTER 106



QUIDAM 484



MICHIGAN 470



BALOUBET 545

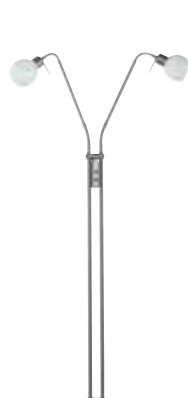

FREDDY 557



VERONA 483



NARCOS 485



GINELLI 155



KAZAN





# Get your light connected.

TRIO Leuchten mit WiZ-Technologie ermöglichen ein faszinierendes und innovatives Lichtdesign, das sich vollkommen individuell steuern, programmieren und kontrollieren lässt.

Die smarte Lichtsteuerung liefert dabei unbegrenzte Möglichkeiten für jeden Anlass die gewünschte Atmosphäre zu kreieren - ob per App, Sprachsteuerung, Fernbedienung und den herkömmlichen Wandschalter.

TRIO luminaires with WiZ technology enable fascinating and innovative lighting settings that can be individually managed, programmed and controlled.

The smart lighting control provides unlimited possibilities to create the desired atmosphere for every occasion - whether via app, voice control, remote control and the conventional wall switch.



# Get your light connected.



Sensors



Summer



Schedules



Warm white



Daylight



Moments



Party



Voice control



Mojito



works with the  
Google Assistant





INNOVATIVE

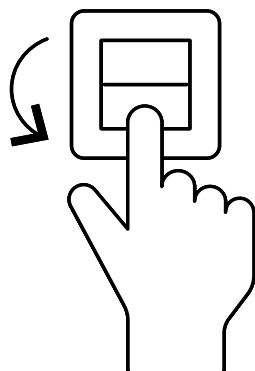

## WiZ CLICK

Einfach und effektiv. Zwei bevorzugte Lichtmodi können über den vorhandenen Lichtschalter bedient werden.

Simple and effective. Two preferred light modes can be operated via the existing light switch.

# WiZ CONNECTED

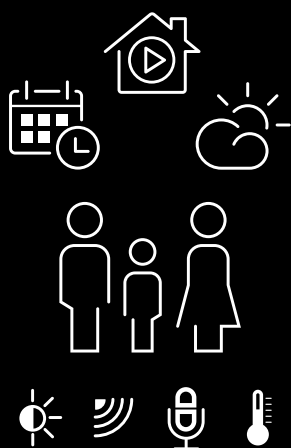

## WiZ MAGIC

Steuerung der Leuchten über Zeitpläne, Sensoren oder einfache Sprachbefehle. Kompatibel mit Amazon Alexa und Google Home.

Control of the lights by time schedules, with sensors or by simple verbal commands. Compatible with Amazon Alexa and Google Home.



## WiZ APP

Einfach und schnell installiert. Volle Funktionalität und Flexibilität mit der WiZ App – erhältlich im App Store oder bei Google Play.

Easy and quick to install. Full functionality and flexibility with the WiZ App - available on the App Store or on Google Play.



## WiZ MOTE

Steuerung über die Fernbedienung und Abspeichern von vier favorisierten Lichtmodi möglich.

Control via the remote control and possibility to save four favorite light modes.

# DIMMING



64.000 **WEISSTÖNE**  
64,000 **WHITES**



Voreingestellte Lichtmodi · Preset light modes



16 Millionen **FARBEN**  
16 million **COLORS**



Dynamische Lichtmodi · Dynamic light modes



Steuerung der Leuchten mit einfachen Sprachbefehlen.

Control of the lights with simple voice commands.



Einfaches Programmieren von Lichtszenarien.

Simple programming of light scenarios.



Einrichten und Steuern der Leuchten über Zeitpläne.

Control of the lights by time schedules.

# FLEXIBLE

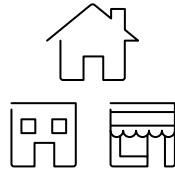

## Mehrere Standorte

Kontrollieren und Steuern von mehreren Standorten gleichzeitig und von überall aus. Ob das eigene Zuhause oder die Ferienwohnung.

## Multiple locations

Control and command multiple locations simultaneously and from anywhere. Whether your own home or your holiday home.

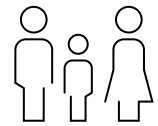

## Mehrere Nutzer

Die Anzahl der Nutzer zur Steuerung der Leuchten kann individuell festgelegt werden.

## Multiple user

The number of persons to control the lights can be set individually.



## Cloud basiert.

WiZ verbindet sich mit der Cloud, damit Vorlieben gespeichert, Wünsche geteilt und Updates automatisch generiert werden.

## Cloud based

WiZ connects to the cloud to store preferences, share desires and generate updates automatically.



## Mehrere Räume

Alle Leuchten können unterschiedlichen Räumen zugeordnet und präzise gesteuert werden – einzeln oder in Gruppen.

## Several rooms

All lights can be assigned to different rooms and precisely controlled - individually or in groups.

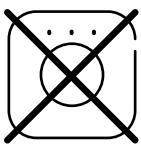

## Keine zusätzliche Bridge erforderlich

Es wird keine zusätzliche Bridge oder Hub für die Steuerung der Leuchten benötigt.

## No additional hub needed

There is no need for an additional bridge or hub to control the lights.

# SMART



## Wlan Technologie

WiZ nutzt Wlan-Technologie als sichere, unabhängige, kostengünstige und einfach zu installierende Funklösung.

## WiFi technology

WiZ uses Wi-Fi technology as a secure, independent, affordable and easy-to-install wireless solution.



Starlight effect

## NALIDA

Acryl · acryl ·  
acryl · acryl · acrílico · acrilico ·  
acrilic · akryyli · akryl · akrilik



inkl. Fernbedienung  
remote included



Ø 74 cm, ↓ 10 cm  
incl. RGBW-LED, 40 W  
max. 3.700 lm, 3.000 - 5.500 K



656090101



Starlight effect  
Ø 74 cm, ↓ 10 cm  
incl. RGBW-LED, 40 W  
max. 3.700 lm, 3.000 - 5.500 K



656090100

## MELBY

Nickel matt, Acryl · nickel mat, acryl ·  
nickel mat, acryl · nikkel mat, acryl · níquel mate, acrílico ·  
nichel opaco, acrílico · nichel mat, acrílico · harjattu teräs, akryyli ·  
nikiel mat, akryl · mat nikel, akrilik



Gibt Licht nach oben und unten · up and down lighting ·  
point lumineux en haut et en bas · lichtpunt boven en onder ·  
luz de arriba y abajo · luce su e giù · sus și în jos lumina ·  
ylös ja alas valoa · w górę iw dół światło · yukarı ve aşağı ışık



inkl. Fernbedienung  
remote included

↔ max. 242 cm, ↓ 12 cm  
incl. RGBW-LED, 23 W  
max. 2.200 lm, 3.000 - 5.000 K



651210507



## IMARA

Acryl · acryl ·  
acryl · acryl · acrílico · acrilico ·  
acrilic · akryyli · akryl · akrilik



inkl. Fernbedienung  
remote included



Starlight effect



## CHARLY

Acryl · acryl ·  
acryl · acryl · acrílico · acrilico ·  
acrilic · akryyli · akryl · akrilik



↔ 110 x 30 cm, ↑ 7,7 cm  
incl. RGBW-LED, 40 W  
max. 3.700 lm, 3.000 - 5.500 K



658810101

Starlight effect  
↔ 110 x 30 cm, ↑ 7,7 cm  
incl. RGBW-LED, 40 W  
max. 3.700 lm, 3.000 - 5.500 K



658810100

Ø 50 cm, ↑ 12 cm  
incl. RGBW-LED, 27 W  
max. 2.550 lm, 3.000 - 5.500 K



656010101

Starlight effect  
Ø 50 cm, ↑ 12 cm  
incl. RGBW-LED, 27 W  
max. 2.550 lm, 3.000 - 5.500 K



656010100

Starlight effect



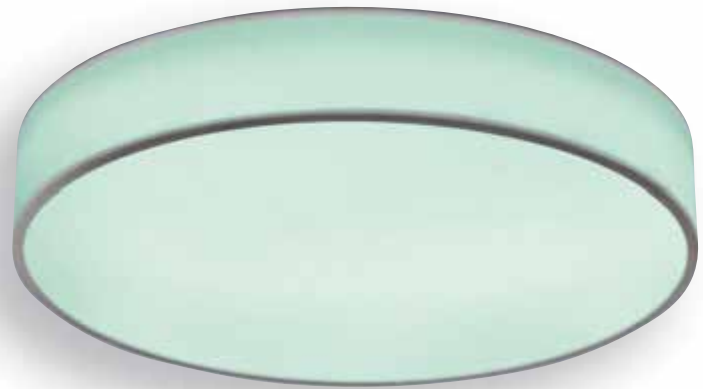

## DIAMO

Stoff weiß · fabric white ·  
tissu blanc · textiel wit · tela blanco · tessuto bianco ·  
textil alb · tekstiili valkoinen · tkanina biały · kumaş beyaz



46



inkl. Fernbedienung  
remote included



Ø 60 cm, ↑ 10 cm  
incl. RGBW-LED, 36 W  
max. 3.400 lm, 3.000 - 5.000 K



651914001

Ø 75 cm, ↑ 10 cm  
incl. 1 x RGBW-LED, 45 W  
max. 4.200 lm, 3.000 - 5.000 K



651915501



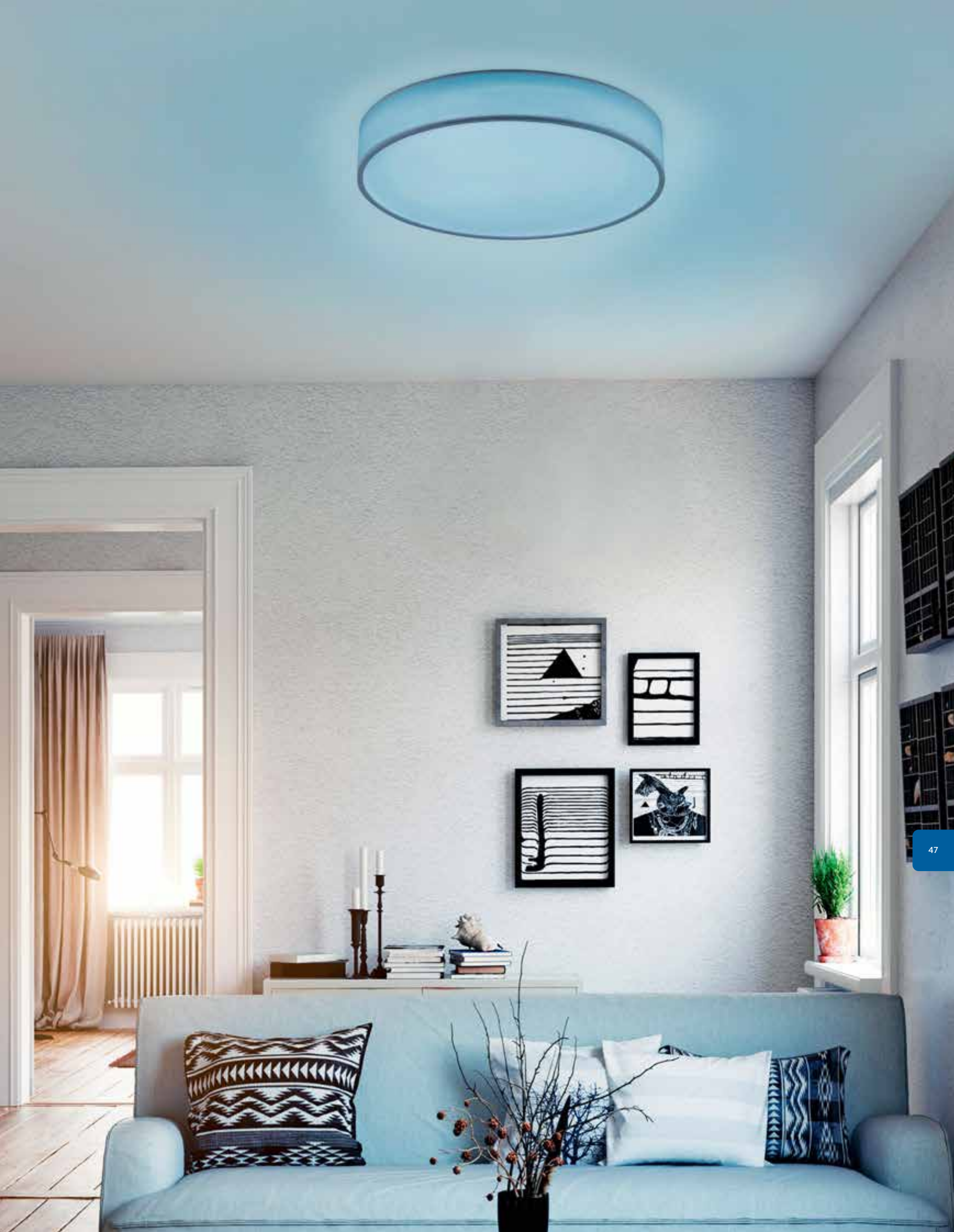



07

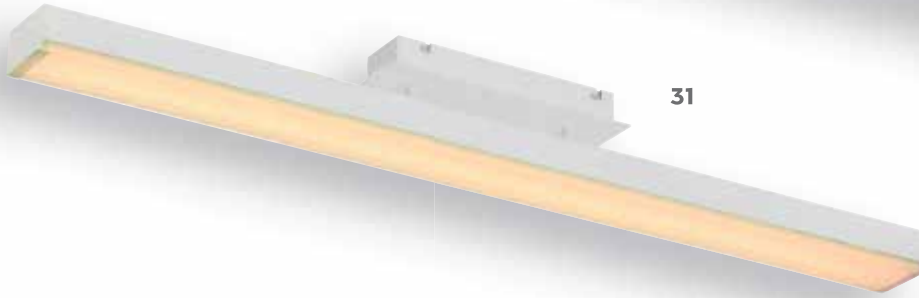

31



# LIVARO

Nickel matt oder weiß matt · nickel mat or white mat ·  
nickel mat ou blanc mat · nikkell mat of wit mat ·  
níquel mate o estera blanca · nichel opaco o bianco opaco ·  
nichel mat sau alb mat · harjattu teräs tai valkoinen matto ·  
nikiel mat lub biały mat · mat nikel veya beyaz mat



inkl. Fernbedienung  
remote included

↔ 100 x 8 cm, ↑ 12 cm  
incl. RGBW-LED, 20 W  
max. 2.000 lm, 3.000 - 5.000 K



658210107  
658210131

↔ 100 x 8 cm, ↑ 150 cm  
incl. RGBW-LED, 20 W  
max. 2.000 lm, 3.000 - 5.000 K



358210107  
358210131



**07** Nickel matt · nickel mat  
**31** weiß matt · white mat





32



## GEMINI

Metall, weiß matt oder schwarz matt · metal, white mat or black mat ·  
 metale, blanc mat ou noir mat · metaal, wit mat of mat zwart ·  
 metal, estera blanca o estera negra · metallo, bianco opaco o nero opaco ·  
 metal, alb mat sau negru mat · metalli, valkoinen matto tai musta matto ·  
 metal, biały mat lub czarny mat · metal, beyaz mat veya siyah mat



inkl. Fernbedienung  
remote included



↔ 13 x 13 cm, ↕ 14,5 cm  
incl. 1 x RGBW-LED, 3 W  
max. 300 lm, 3.000 - 5.000 K



850010131  
850010132

↔ 32 x 8 cm, ↕ 14,5 cm  
incl. 2 x RGBW-LED, 3 W  
max. 2 x 300 lm, 3.000 - 5.000 K



850010231  
850010232

↔ 43 x 8 cm, ↕ 14,5 cm  
incl. 3 x RGBW-LED, 3 W  
max. 3 x 300 lm, 3.000 - 5.000 K



850010331  
850010332

↔ 25 x 25 cm, ↕ 14,5 cm  
incl. 4 x RGBW-LED, 3 W  
max. 4 x 300 lm, 3.000 - 5.000 K



850010431  
850010432



31

51



- 31 weiß matt · white mat
- 32 schwarz matt · black mat



## DAMIAN

Nickel matt, Glas weiß · nickel mat, glass white ·  
 nickel mat, verre blanc · nikkell mat, glas wit · níquel mate, vidrio blanco ·  
 nichel opaco, vetro bianco · nichel mat, sticla alb · harjattu teräs, lasi valkoinen ·  
 nikiel mat, szkło biały · mat nikel, cam beyaz



Ø 30 cm, ↑ 29 cm  
 incl. 1 x RGBW-LED E27, 11,5 W  
 max. 806 lm, 2.200 - 6.500 K



551610107



Ø 30 cm, ↑ 150 cm  
 incl. 1 x RGBW-LED E27, 11,5 W  
 max. 806 lm, 2.200 - 6.500 K



351610107



Ø 45 cm, ↑ 150 cm  
 incl. 1 x RGBW-LED E27, 11,5 W  
 max. 806 lm, 2.200 - 6.500 K



351690107



inkl. Fernbedienung  
 remote included





# TRISTAN

Metall, Glas matt · metal, mat glass ·  
metale, verre mat · metaal, mat glas · metal, vidrio mate · metallo, vetro sabbiato ·  
metal, sticla mata · metalli, matalasi · metal, szkło matowane · metal, mat cam



↔ 13 cm, ↑ 44 cm, ↗ 13 cm  
incl. 1 x RGBW-LED E27, 11,5 W  
max. 806 lm, 2.200 - 6.500 K

↑ 150 cm, Ø 23 cm  
incl. 1 x RGBW-LED E27, 11,5 W  
max. 806 lm, 2.200 - 6.500 K



254700101

354790101



inkl. Fernbedienung  
remote included





64.000  
**WEISSTÖNE**  
64,000 **WHITES**



16 Millionen  
**FARBEN**  
16 million **COLORS**

Voreingestellte Lichtmodi · Preset light modes



Dynamische Lichtmodi · Dynamic light modes



inkl. Fernbedienung  
remote included



wizconnected.com



↓ 109 mm, ↔ 56 mm  
RGBW-LED E14, 7,5 W  
max. 470 lm, 2.200 - 6.500 K  
25.000 h



**983-88**



↓ 118 mm, ↔ 66 mm  
RGBW-LED E27, 11,5 W  
max. 806 lm, 2.200 - 6.500 K  
25.000 h



**987-88**



↓ 73 mm, ↔ 50 mm  
RGBW-LED GU10, 6,5 W  
max. 360 lm, 2.200 - 6.500 K  
25.000 h



**956-88**



# Leuchtenfamilien & Kombinationen

Families & coordinates  
Familles & coordonnés  
Families & combinaties  
Familias & coordinados  
Famiglie & coordinati  
Famillii & Coordonate  
Tuoteperheet & yhdistettävät tuotteet  
Rodzinne orawy & kombinacje  
Aileler & Takımlar



↔ 104 x 42 cm, ↑ 8,5 cm  
incl. SMD-LED, 35 W  
3.300 lm, 3.000 K



672610331

↔ 70 x 30 cm, ↑ 150 cm  
incl. SMD-LED, 26 W  
2.200 lm, 3.000 K



372610331

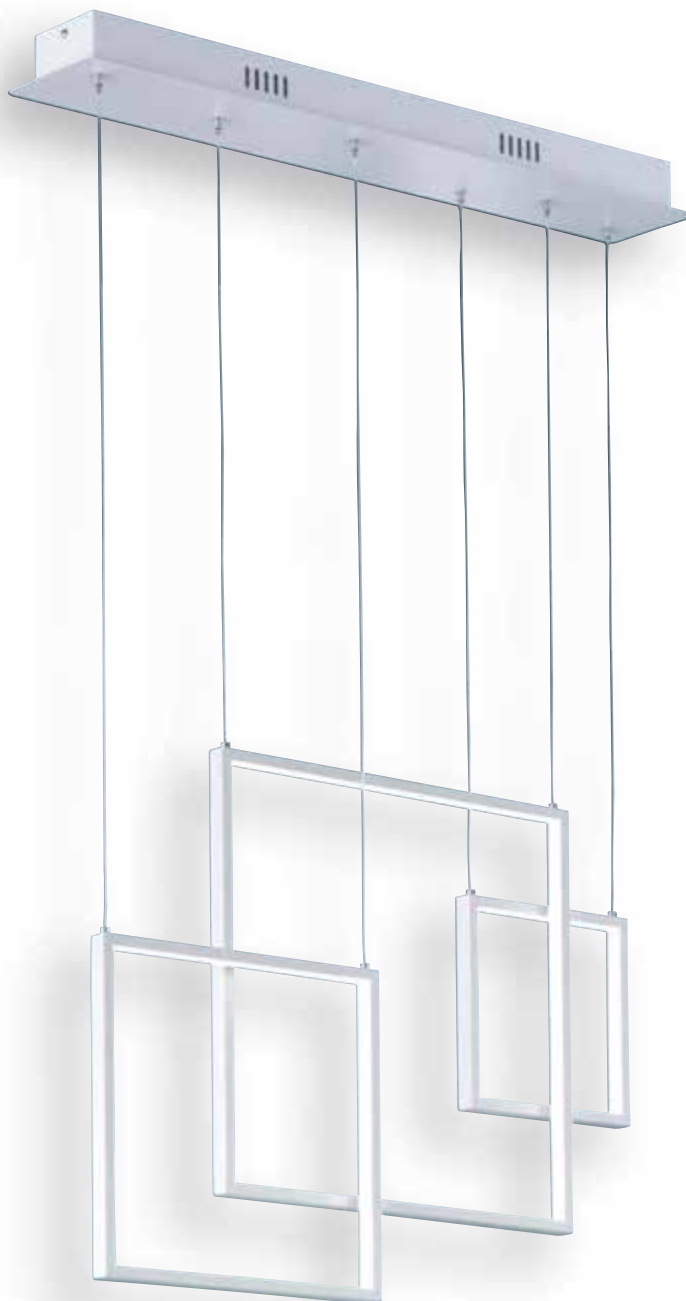

## TUCSON

Metall, weiß matt · metal, white mat ·  
metale, blanc mat · metaal, wit mat · metal, estera blanca ·  
metallo, bianco opaco · metal, alb mat · metalli, valkoinen matto ·  
metal, biały mat · metal, beyaz mat

**LED SWITCHDIMMER**



↑ 160 cm, ↔ 44 cm  
incl. SMD-LED, 44 W  
3.750 lm, 3.000 K



472610531





↔ 114 x 30 cm, ↑ 150 cm, ↗ 6 cm  
incl. SMD-LED, 30 W  
3.000 lm, 3.000 K



**379910105**



↑ 30 x 4 cm, ↔ 30 cm  
incl. SMD-LED, 9 W  
800 lm, 3.000 K



**579910105**



↑ 141 cm, ↔ 30 cm  
incl. SMD-LED, 26 W  
2.300 lm, 3.000 K



**479910105**





## AZUR

Aluminium gebürstet, chrom · brushed aluminium, chrome ·  
aluminium balayé, chrome · geborsteld aluminium, chroom · aluminio pulido, cromo ·  
alluminio spazzolato, cromo · aluminiu lucios, crom · harjattu alumiini, kromi ·  
aluminium szczotkowane, chrom · alüminyum, krom

**LED SWITCHDIMMER**

LED SWITCH DIMMER

## DICE

Metall, grau antik · metal, antique grey ·  
metale, gris ancien · metaal, antiek grijs ·  
metal, gris antiguo · metallo, grigio antico ·  
metal, antic gri · metalli, antiikki harmaa ·  
metal, starodawny szary · metal, antika gri

62



↔ 30 x 30 cm, ↑ 150 cm  
incl. SMD-LED, 19 W  
1.700 lm, 3.000 K



320113061



↑ 38 cm, ↔ 20 x 20 cm  
incl. SMD-LED, 12,5 W  
1.200 lm, 3.000 K



520112061





LED SWITCHDIMMER

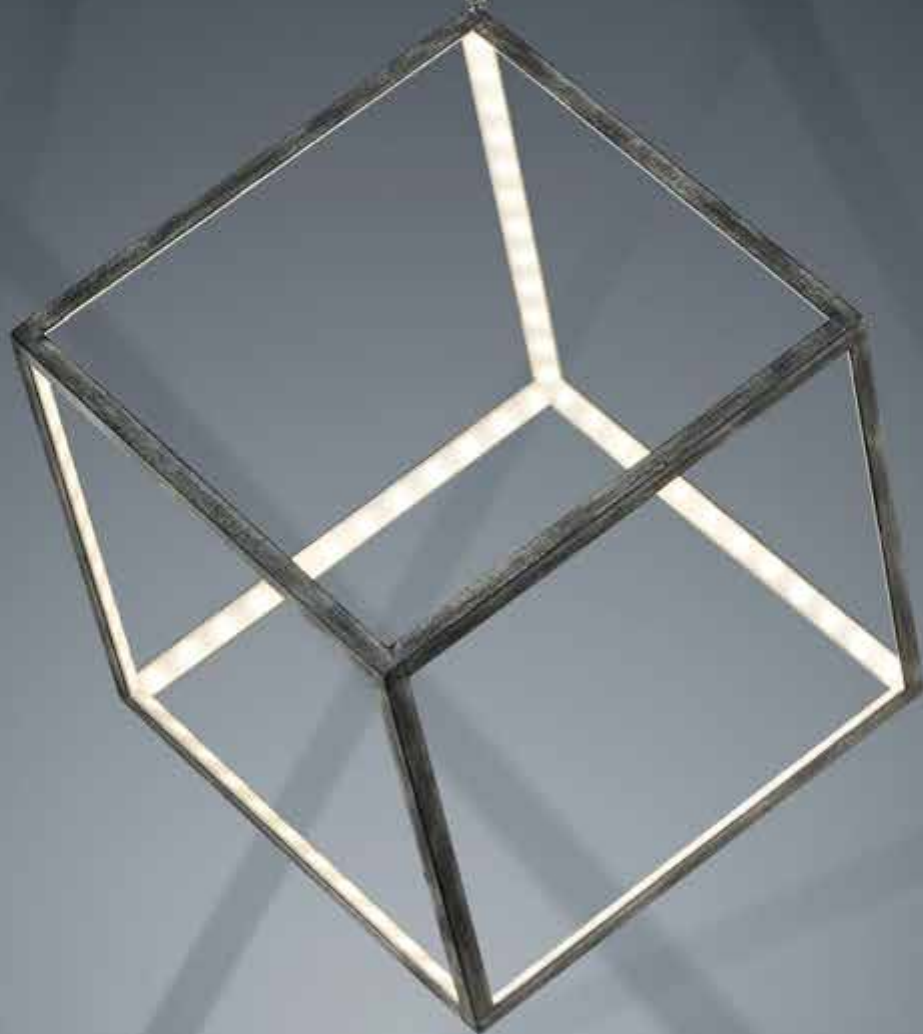

↔ 40 x 40 cm, ↑ 150 cm  
incl. SMD-LED, 22,5 W  
2.000 lm, 3.000 K



320114061

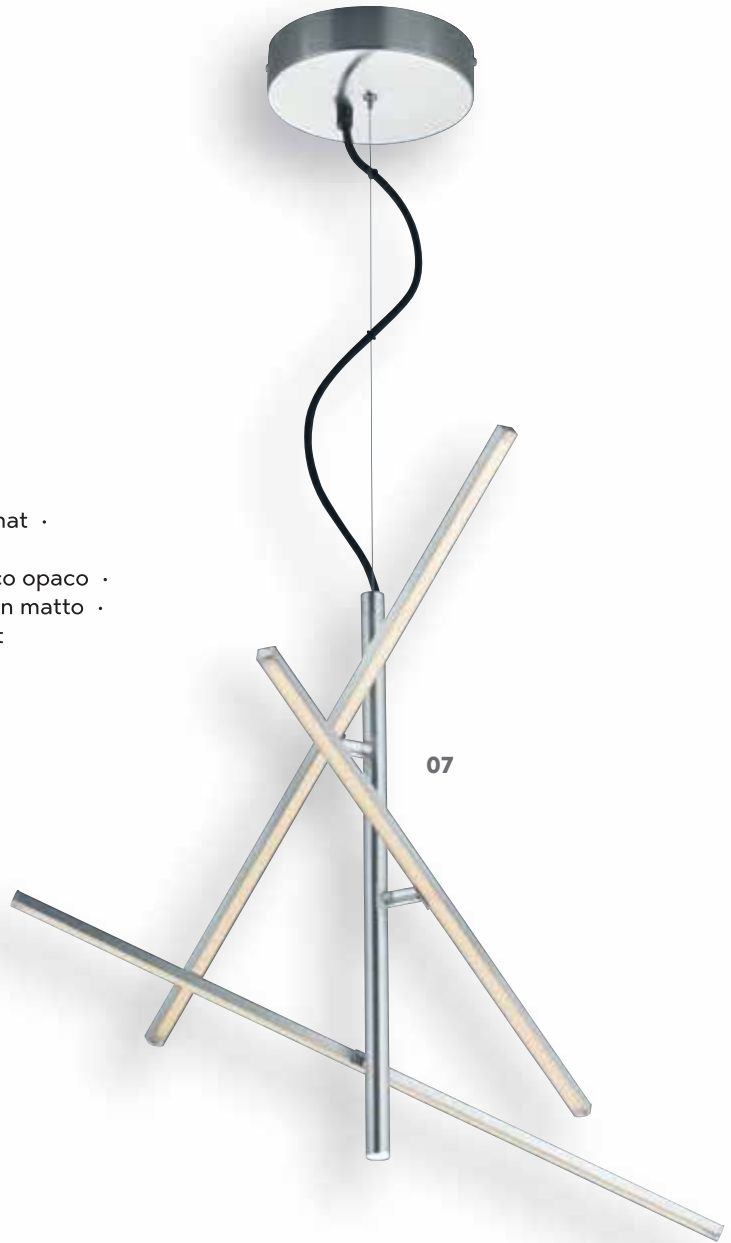
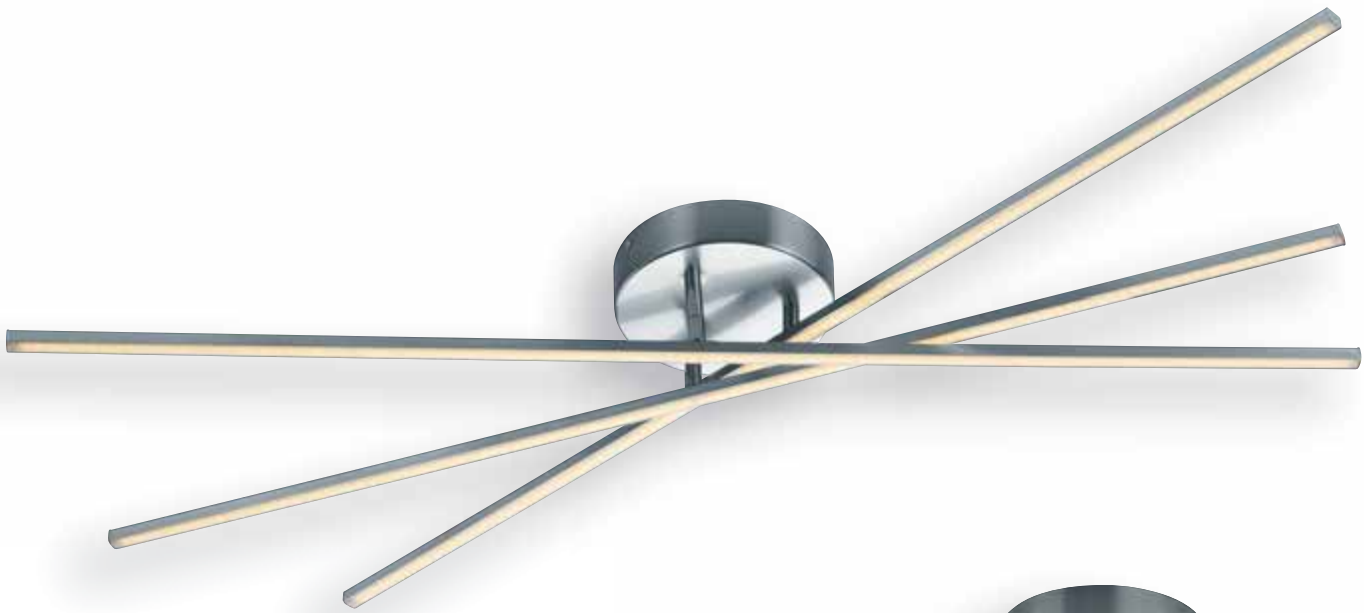

# TIRIAC

Nickel matt oder weiß matt · nickel mat or white mat ·  
 nickel mat ou blanc mat · nikkell mat of wit mat ·  
 níquel mate o estera blanca · nichel opaco o bianco opaco ·  
 nichel mat sau alb mat · harjattu teräs tai valkoinen matto ·  
 nikiel mat lub biały mat · mat nikel veya beyaz mat

## LED SWITCHDIMMER

07

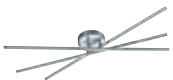

↔ 100 cm, ↓ 12 cm  
 incl. 3 x SMD, 8,5 W  
 3 x 950 lm, 3.000 K

↔ 60 cm, ↓ 150 cm  
 incl. 3 x SMD, 7,5 W  
 3 x 830 lm, 3.000 K

↔ 100 cm, ↓ 150 cm  
 incl. 3 x SMD, 8,5 W  
 3 x 950 lm, 3.000 K



671610307  
 671610331

371690307  
 371690331

371610307  
 371610331



07 Nickel matt · nickel mat  
 31 weiß matt · white mat



31



↑ 50 cm, ↗ 13 cm  
incl. 2 x SMD-LED, 5 W  
2 x 500 lm, 3.000 K



277690206



↔ 115 x 2 cm, ↑ 120 cm  
incl. 1 x SMD-LED, 24 W  
2.200 lm, 3.000 K



377610106



Ø 95,5 cm, ↑ 15 cm  
incl. 6 x SMD-LED, 5 W  
6 x 500 lm, 3.000 K



677610606



## SANDRO

chrom, Acryl · chrome, acryl ·  
chrome, acryl · chroom, acryl · cromo, acrílico · cromo, acrilico ·  
crom, acrilic · kromi, akryyli · chrom, akryl · krom, akrilik



## OPIUM

Nickel matt, chrom, Acryl · nickel mat, chrome, acryl ·  
 nickel mat, chrome, acryl · nikkell mat, chroom, acryl ·  
 níquel mate, cromo, acrílico · nichel opaco, cromo, acrílico ·  
 nichel mat, crom, acrílic · harjattu teräs, kromi, akryyli ·  
 nikiel mat, chrom, akryl · mat nikel, krom, akrilik



↑ 35 cm, ↔ 14 x 14 cm  
 incl. 1 x SMD-LED, 4,5 W  
 430 lm, 3.000 K

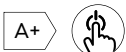

570610107



↑ 150 cm, ↔ 22 x 22 cm  
 incl. 3 x SMD-LED, 4,5 W  
 3 x 430 lm, 3.000 K

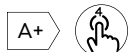

470690307



↔ 80 cm, ↑ 95 - 160 cm  
 incl. 4 x SMD-LED, 4,5 W  
 4 x 430 lm, 3.000 K



370610407



LED SWITCHDIMMER





## OPIUM

Nickel matt, chrom, Acryl · nickel mat, chrome, acryl ·  
 nickel mat, chrome, acryl · nikkell mat, chroom, acryl ·  
 níquel mate, cromo, acrílico · nichel opaco, cromo, acrílico ·  
 nichel mat, crom, acrylic · harjattu teräs, kromi, akryyli ·  
 nikiel mat, chrom, akryl · mat nikel, krom, akrilik



70



↔ 7 x 14,5 cm, ↗ 16 cm  
 incl. 1 x SMD-LED, 4,5 W  
 430 lm, 3.000 K



870670107



↔ 36 x 7 cm, ↑ 20 cm  
 incl. 2 x SMD-LED, 4,5 W  
 2 x 430 lm, 3.000 K



870610207



↔ 51 x 7 cm, ↑ 20 cm  
 incl. 3 x SMD-LED, 4,5 W  
 3 x 430 lm, 3.000 K



870610307



↔ 75 x 7 cm, ↑ 20 cm  
 incl. 4 x SMD-LED, 4,5 W  
 4 x 430 lm, 3.000 K



870610407



↔ 25 x 25 cm, ↑ 15 cm  
 incl. 4 x SMD-LED, 4,5 W  
 4 x 430 lm, 3.000 K



670610407







# SILAS

Aluminium gebürstet · brushed aluminium ·  
aluminium balayé · geborsteld aluminium · aluminio pulido ·  
alluminio spazzolato · aluminiu lucios · harjattu alumiini ·  
aluminium szczotkowane · alüminyum



4 fach Touch  
4 level touch

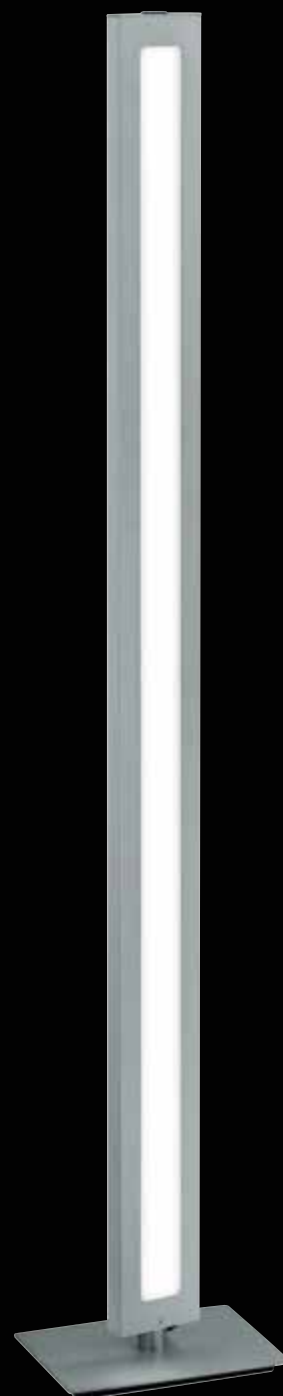

↔ 115 x 8 cm, ↑ 120 cm  
incl. SMD-LED, 45 W  
4.500 lm, 3.000 K



372294505



↔ 80 x 8 cm, ↑ 6 cm  
incl. SMD-LED, 24 W  
2.400 lm, 3.000 K



672212405



↔ 20 x 15 cm, ↑ 116 cm  
incl. SMD-LED, 20 W  
1.800 lm, 3.000 K



472290105





Gestensteuerung · Gesture control ·  
Contrôle gestuel · Gebaarbediening ·  
Control gestual · Controllo gestuale ·  
Control prin gesturi/miscarea mainii ·  
Kädellä ohjattava liiketunnistin ·  
Sterowana gestami · Jest Kontrol

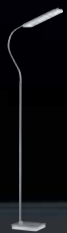

↑ 160 x 18 cm, ∅ 51  
incl. SMD-LED, 12 W  
1.050 lm, 3.000 K



470110107





Gestensteuerung · Gesture control ·  
Contrôle gestuel · Gebaarbediening ·  
Control gestual · Controllo gestuale ·  
Control prin gesturi/miscarea mainii ·  
Kädellä ohjattava liiketunnistin ·  
Sterowana gestami · Jest Kontrol



## GESTIC

Nickel matt, Acryl · nickel mat, acryl ·  
nickel mat, acryl · nikkell mat, acryl · níquel mate, acrílico ·  
nichel opaco, acrilico · nichel mat, acrilic · harjattu teräs, akryyli ·  
nikiel mat, akryl · mat nikel, akrilik

75



↔ 105 x 10 cm, ↑ 150 cm  
incl. 3 x SMD-LED, 12 W  
3 x 1.050 lm, 3.000 K



370110307

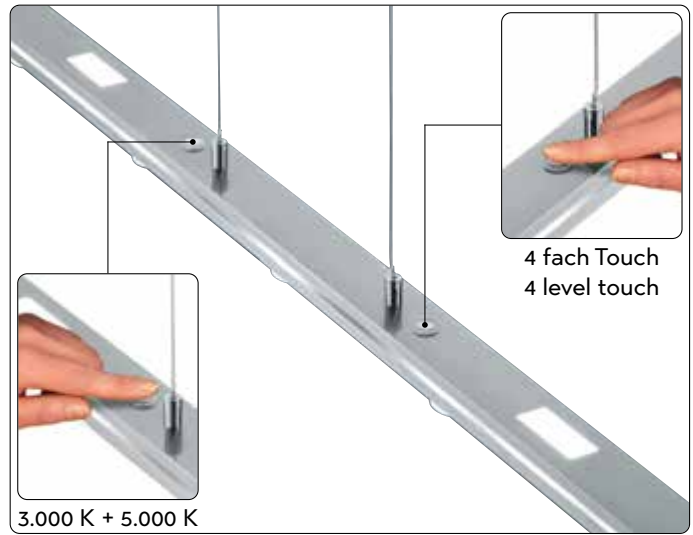
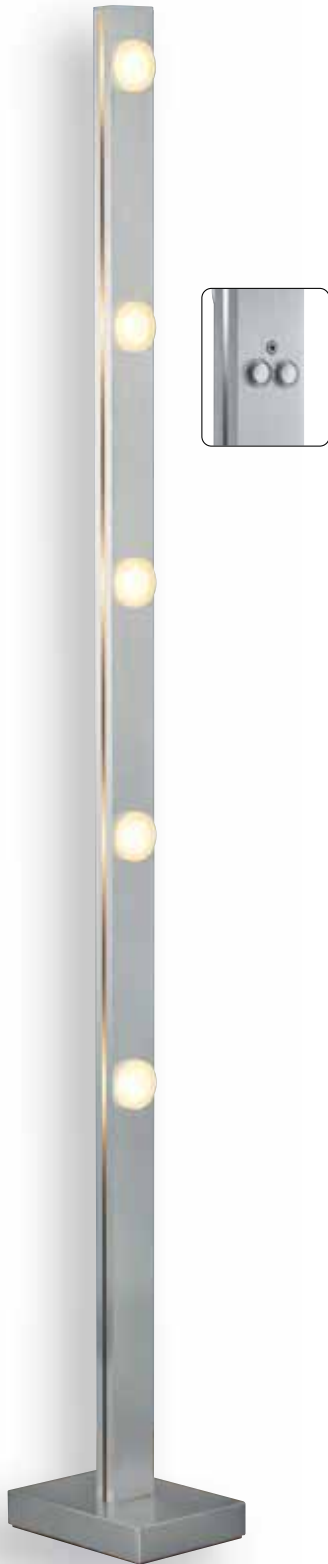

Gibt Licht nach oben und unten · up and down lighting ·  
 point lumineux en haut et en bas · lichtpunt boven en onder ·  
 luz de arriba y abajo · luce su e giù · sus și în jos lumina ·  
 ylös ja alas valoa · w górę iw dół światło · yukarı ve aşağı ışık



↓ 50 cm, ↔ 10 x 18 cm  
 incl. 2 x SMD-LED, 3,5 W  
 2 x 350 lm, 3.000 + 5.000 K



579190207  
 579190279



↓ 140 cm, ↔ 13 x 19 cm  
 incl. 5 x SMD-LED, 3,5 W  
 5 x 350 lm, 3.000 + 5.000 K



479190507  
 479190579



↔ 100 cm, ↓ 95 - 160 cm  
 incl. 7 x SMD-LED, 3,5 W  
 7 x 350 lm, 3.000 + 5.000 K



379190707  
 379190779



07 Nickel matt · nickel mat  
 79 goldfarbig · gold



## LACAL

Nickel matt oder goldfarbig · nickel mat or gold ·  
nickel mat ou or · nikkell mat of goud ·  
níquel mate o oro · nichel opaco o oro ·  
nichel mat sau aur · harjattu teräs tai kultaa ·  
nikiel mat lub złota · mat nikel veya altın



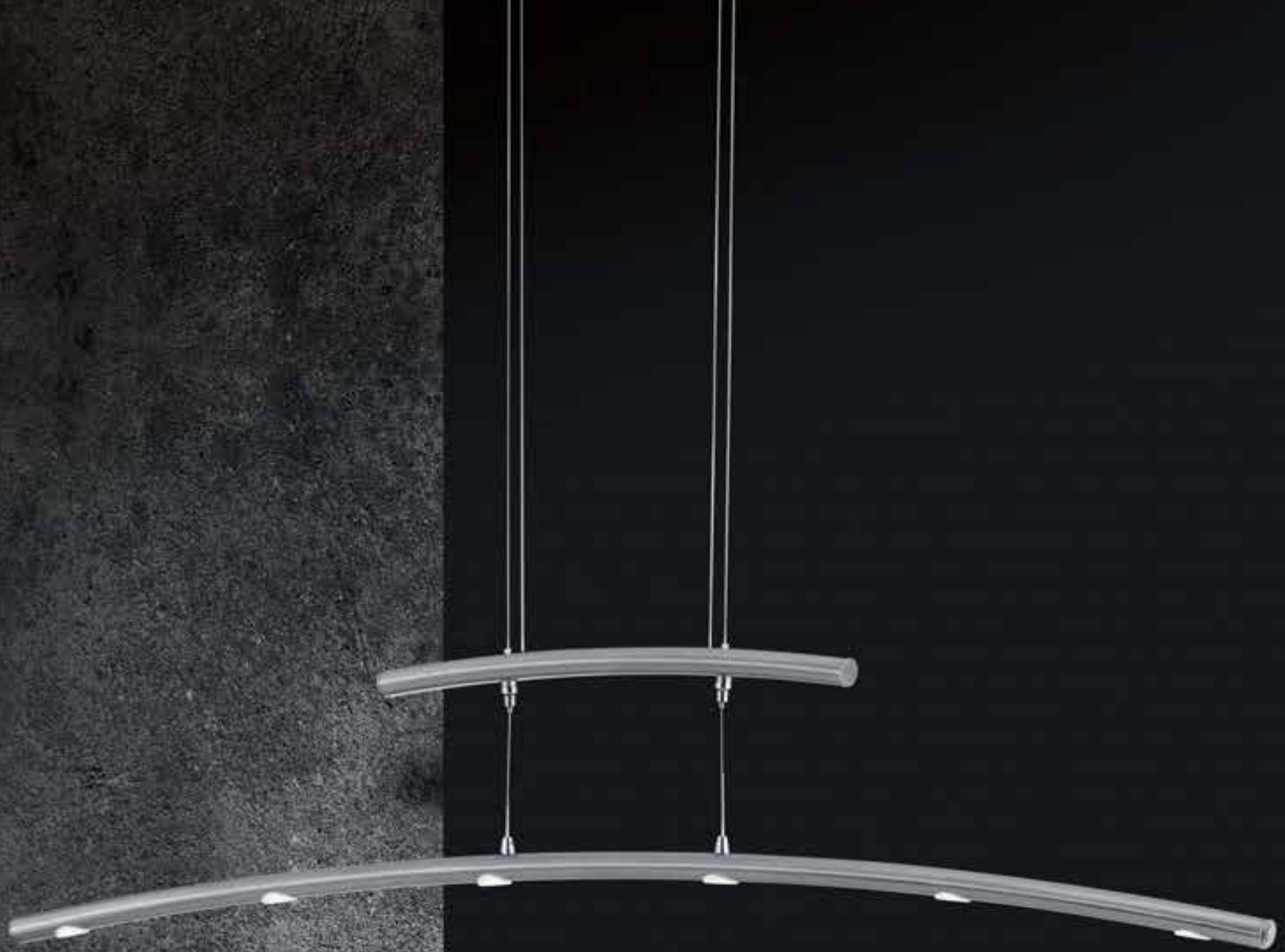

## COLUMBUS

Nickel matt · nickel mat ·  
 nickel mat · nikkell mat · níquel mate · nichel opaco ·  
 nichel mat · harjattu teräs · nikiel mat · mat nikel



4 fach Touch  
 4 level touch



↑ 168 cm, ↗ 130 cm, Ø 35 cm  
 incl. 4 x SMD-LED, 4,5 W  
 4 x 430 lm, 3.000 K



478490407



↔ 110 cm, ↑ 95 - 160 cm  
 incl. 6 x SMD-LED, 4,5 W  
 6 x 430 lm, 3.000 K



378490607





# LOOP

Nickel matt · nickel mat ·  
nickel mat · nikkell mat · níquel mate · nichel opaco ·  
nichel mat · harjattu teräs · nikiel mat · mat nikel

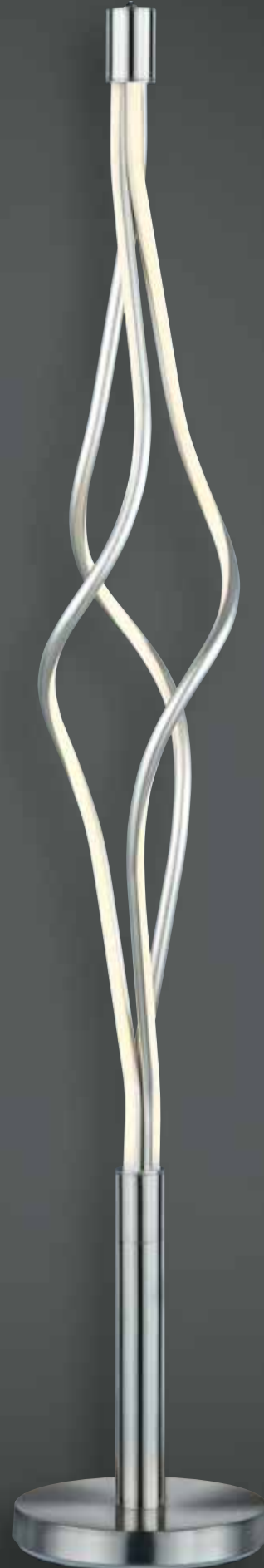

↔ 117 x 15 cm, ↓ 150 cm  
incl. 3 x SMD-LED, 9 W  
3 x 850 lm, 3.000 + 5.000 K



379890307



↓ 57 cm, Ø 16 cm  
incl. 3 x SMD-LED, 4,5 W  
3 x 300 lm, 3.000 + 5.000 K



579890307



↓ 138 cm, Ø 23 cm  
incl. 3 x SMD-LED, 9 W  
3 x 850 lm, 3.000 + 5.000 K



479890307



LED SWITCHDIMMER



# OLYMPUS

chrom, Aluminium · chrome, aluminium ·  
chrome, aluminium · chroom, aluminium ·  
cromo, aluminio · cromo, alluminio · crom, aluminu ·  
kromi, alumiini · chrom, aluminium · krom, alüminyum



4 fach Touch  
4 level touch

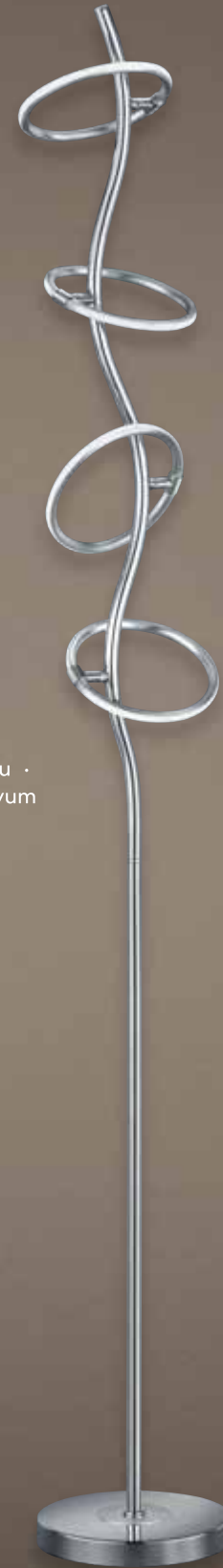

↔ 16,5 cm, ↑ 18 cm, ↗ 18,5 cm  
incl. 1 x SMD-LED, 4,2 W  
450 lm, 3.000 K



270970106



Ø 54 cm, ↓ 26,5 cm  
incl. 6 x SMD-LED, 4,2 W  
6 x 450 lm, 3.000 K



670910606



↔ 115 x 17,5 cm, ↓ 150 cm  
incl. 6 x SMD-LED, 4,2 W  
6 x 450 lm, 3.000 K



370910606



↓ 60 cm, ↔ 17,5 cm,  
incl. 2 x SMD-LED, 4,2 W  
2 x 450 lm, 3.000 K



570990206



↑ 165 cm, ↔ 21 cm  
incl. 4 x SMD-LED, 4,2 W  
4 x 450 lm, 3.000 K



470910406

LED SWITCHDIMMER





# PORTOFINO

chrom, Acryl · chrome, acryl ·  
chrome, acryl · chroom, acryl · cromo, acrílico · cromo, acrilico ·  
crom, acrilic · kromi, akryyli · chrom, akryl · krom, akrilik



↔ 11 cm, ↑ 83 cm, ↗ 28 cm  
incl. 2 x SMD-LED, 8 W  
2 x 800 lm, 3.000 K



276370206



↑ 85 cm, Ø 16 cm  
incl. 2 x SMD-LED, 8 W  
2 x 800 lm, 3.000 K



576390206



↑ 155 cm, Ø 21 cm  
incl. 2 x SMD-LED, 12 W  
2 x 1.200 lm, 3.000 K



476310206

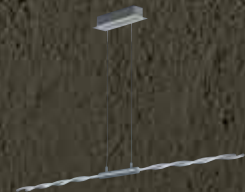

↔ 149 cm, ↑ 150 cm  
incl. 4 x SMD-LED, 7 W  
4 x 700 lm, 3.000 K



376310406



LED SWITCHDIMMER

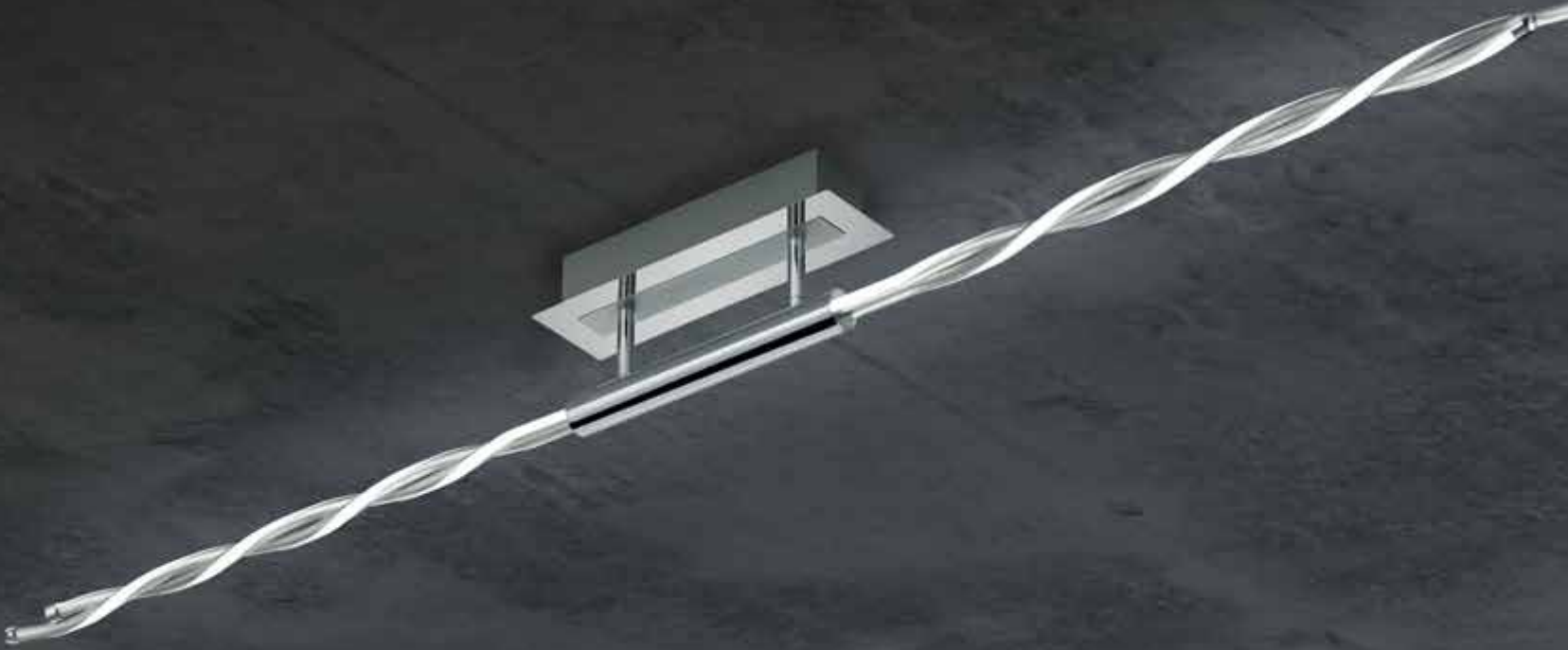

↔ 149 cm, ↑ 14 cm  
incl. 4 x SMD-LED, 7 W  
4 x 700 lm, 3.000 K



676310206



↑ 23 cm, Ø 85 cm  
incl. 4 x SMD-LED, 4,1 W, 4 x 410 lm  
incl. 4 x SMD-LED, 2,8 W, 4 x 280 lm  
3.000 K



676310806





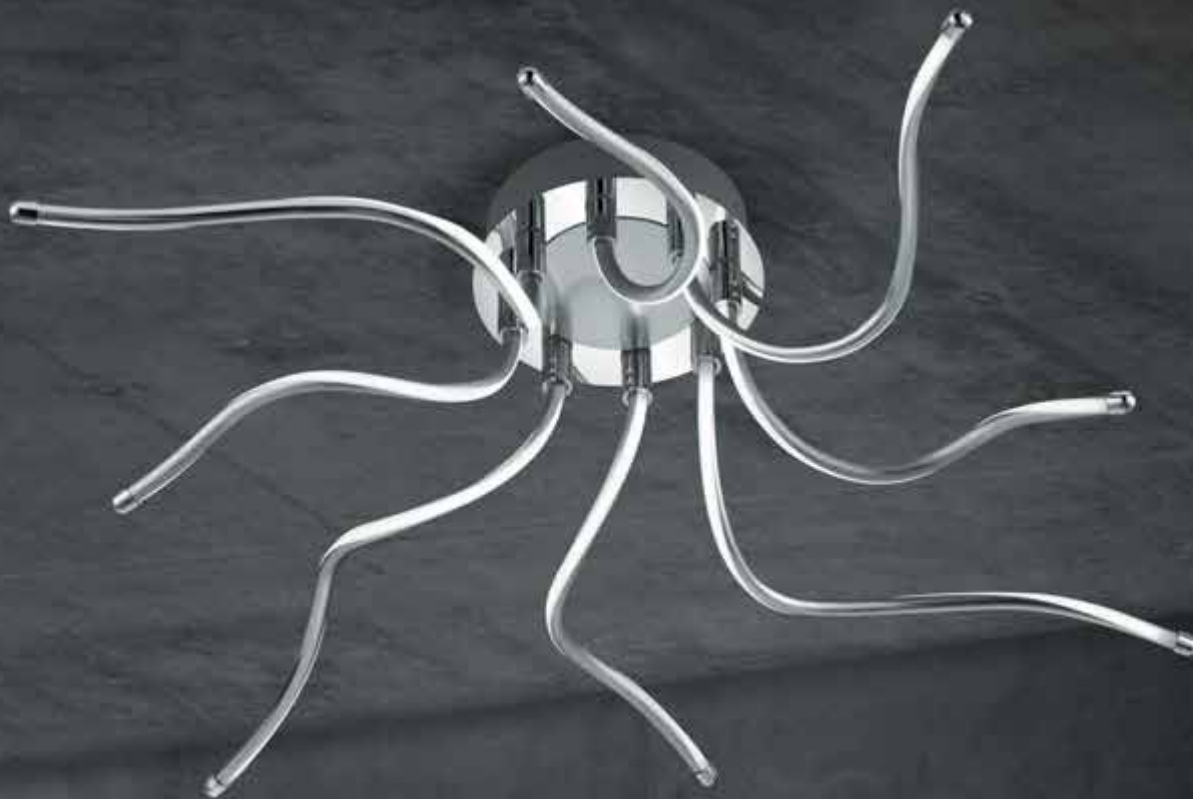

## PORTOFINO

chrom, Acryl · chrome, acryl ·  
chrome, acryl · chroom, acryl · cromo, acrílico · cromo, acrílico ·  
crom, acrílic · kromi, akryyli · chrom, akryl · krom, akrilik

LED SWITCHDIMMER





# MESSINA

Nickel matt / Aluminium gebürstet, Acryl · nickel mat / brushed aluminium, acryl ·  
 nickel mat / aluminium balayé, acryl · nikkell mat / geborsteld aluminium, acryl ·  
 níquel mate / aluminio pulido, acrílico · nichel opaco / alluminio spazzolato, acrilico ·  
 nichel mat / aluminiu lucios, acrilic · harjattu teräs / harjattu alumiini, akryyli ·  
 nikiel mat / aluminium szczotkowane, akryl · mat nikel / alüminyum, akrilik



↔ 100 x 22 cm, ↑ 29 cm  
 incl. SMD-LED, 24,3 W  
 2.200 lm, 2.700 K



623012407



↔ 100 x 22 cm, ↑ 150 cm  
 incl. SMD-LED, 24,3 W  
 2.200 lm, 2.700 K



323012407



↑ 162 cm, ↔ 50 cm  
 incl. SMD-LED, 18,9 W  
 1.700 lm, 2.700 K

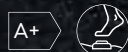

423011807



LED SWITCHDIMMER



↑ 75 cm, ↔ 35 cm, ↗ 30 cm  
incl. SMD-LED, 21 W  
2.100 lm, 3.000 K



227172007



Ø 70 cm, ↓ 26 cm  
incl. SMD-LED, 30 W  
3.200 lm, 3.000 K



627113407



↔ 102 x 62 cm, ↓ 26 cm  
incl. SMD-LED, 40 W  
4.300 lm, 3.000 K



627114807



Ø 70 cm, ↑ 150 cm  
incl. SMD-LED, 30 W  
3.200 lm, 3.000 K



327113407



↔ 102 x 62 cm, ↑ 150 cm  
incl. SMD-LED, 40 W  
4.300 lm, 3.000 K



327114807



LED SWITCHDIMMER

## SALINA

Nickel matt · nickel mat ·  
nickel mat · nikkell mat · níquel mate · nichel opaco ·  
nichel mat · harjattu teräs · nikiel mat · mat nikel



↑ 50 cm, Ø 25 cm  
incl. SMD-LED, 10 W  
1.000 lm, 3.000 K



527111107



↑ 170 cm, ↔ 50 cm  
incl. SMD-LED, 33 W  
3.000 lm, 3.000 K



427113307



↔ 103 cm, ↓ 80 - 130 cm  
incl. SMD-LED, 20 W  
1.800 lm, 3.000 K



372910106



↔ 103 cm, ↓ 27 cm  
incl. SMD-LED, 20 W  
1.800 lm, 3.000 K



672910106



↓ 162 cm, Ø 25 cm  
incl. SMD-LED, 20 W  
1.800 lm, 3.000 K



472910106



↓ 63 cm, Ø 20 cm  
incl. SMD-LED, 14,5 W  
1.300 lm, 3.000 K



572910106



## SYDNEY

chrom, Acryl · chrome, acryl ·  
chrome, acryl · chroom, acryl · cromo, acrílico · cromo, acrilico ·  
crom, acrylic · kromi, akryyli · chrom, akryl · krom, akrilik





## MARIUS

Aluminium gebürstet, chrom · brushed aluminium, chrome · aluminium balayé, chrome · geborsteld aluminium, chrom · aluminio pulido, cromo · alluminio spazzolato, cromo · aluminiu lucios, crom · harjattu alumiini, kromi · aluminium szczotkowane, chrom · alüminyum, krom



↑ 42 x 10 cm, ↗ 9 cm  
incl. 1 x SMD-LED, 10 W  
900 lm, 3.000 K



274191005



↑ 55 cm, ↔ 10 x 15 cm  
incl. 1 x SMD-LED, 10 W  
900 lm, 3.000 K



574191005



↑ 132 cm, ↔ 15 x 22 cm  
incl. 1 x SMD-LED, 25 W  
2.300 lm, 3.000 K



474112505



↔ 100 x 3,5 cm, ↑ 150 cm  
incl. 1 x SMD-LED, 25 W  
2.300 lm, 3.000 K



374112505



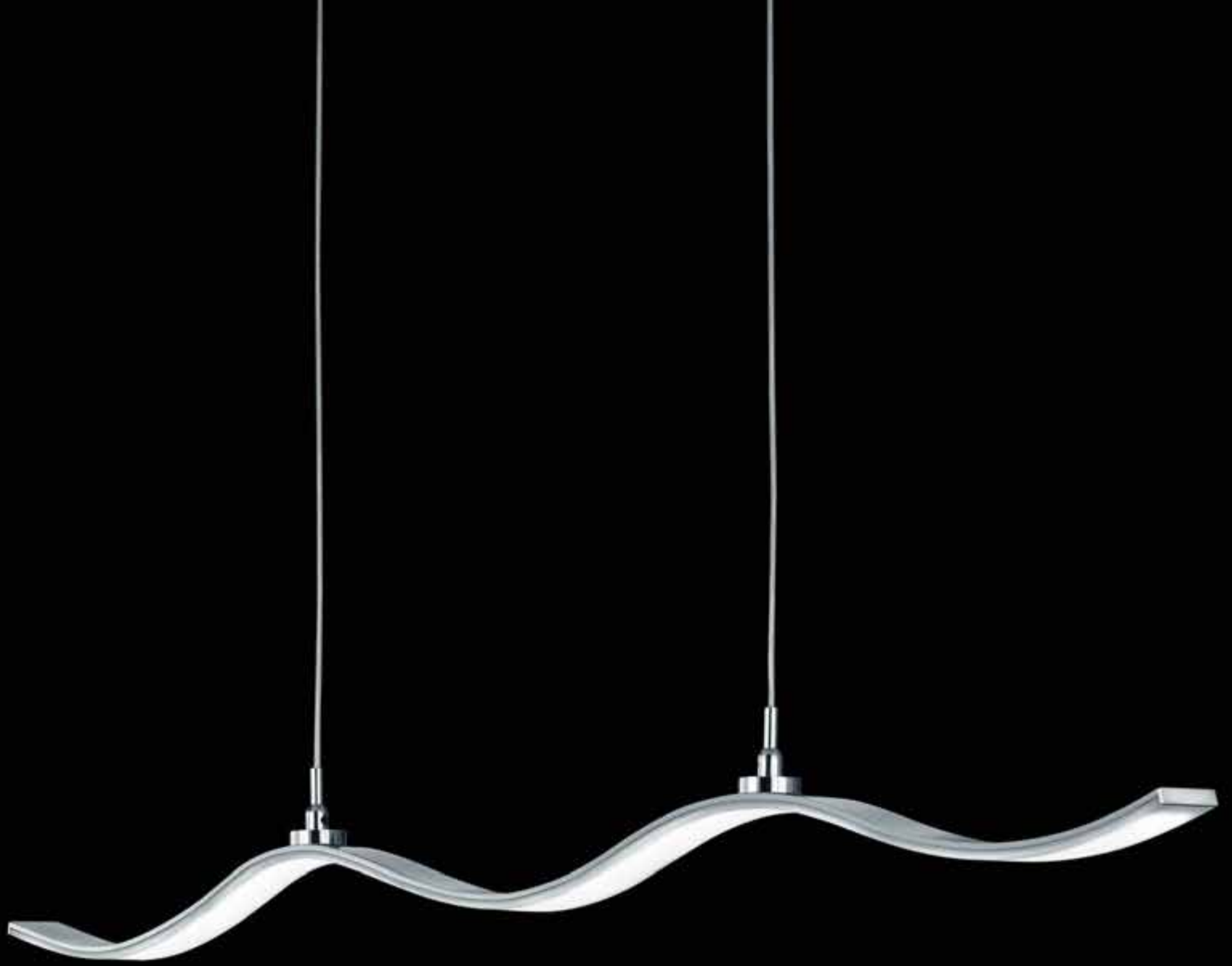



## CORLAND

chrom, Aluminium gebürstet · chrome, brushed aluminium ·  
chrome, aluminium balayé · chroom, geborsteld aluminium ·  
cromo, aluminio pulido · cromo, alluminio spazzolato ·  
chrom, aluminiu lucios · kromi, harjattu alumiini ·  
chrom, aluminium szczotkowane · krom, alüminyum



↔ 48 x 40 cm, ↑ 38 cm  
incl. 1 x SMD-LED, 24 W  
2.160 lm, 3.000 K



674312406



↑ 150 cm, Ø 23 cm  
incl. 3 x SMD-LED, 5 W  
3 x 450 lm, 3.000 K



474310306

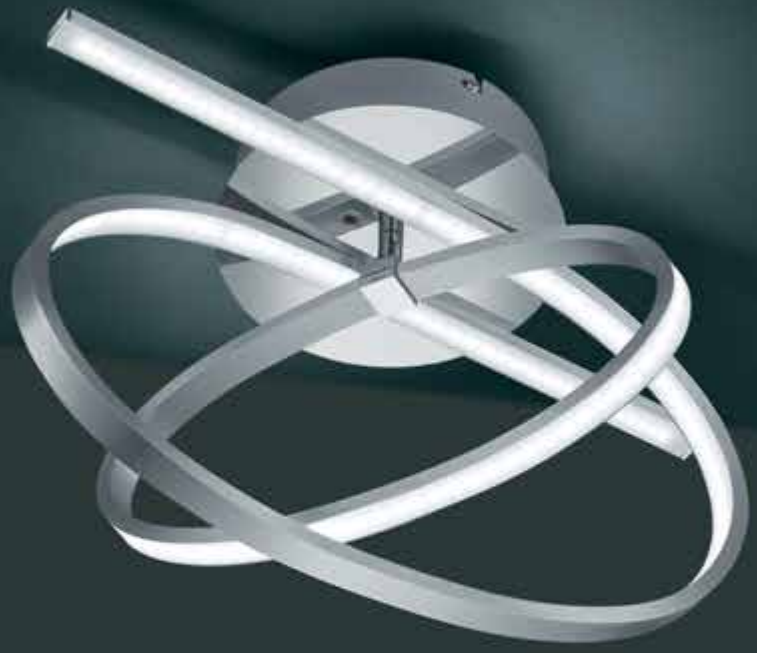

# CORONADO

Aluminium gebürstet, chrom · brushed aluminium, chrome ·  
 aluminium balayé, chrome · geborsteld aluminium, chroom ·  
 aluminio pulido, cromo · alluminio spazzolato, cromo · aluminiu lucios, crom ·  
 harjattu alumiini, kromi · aluminium szczotkowane, chrom · alüminyum, krom



3.000 K

4.400 K

6.700 K



↔ 42 x 32 cm, ↓ 27 cm  
 incl. SMD-LED, 30 W  
 2.200 lm, 3.000 + 4.400 + 6.700 K

↔ 42 x 32 cm, ↓ 150 cm  
 incl. SMD-LED, 30 W  
 2.200 lm, 3.000 + 4.400 + 6.700 K



674910106



374910106



## CATOKI

chrom, Acryl · chrome, acryl ·  
 chrome, acryl · chroom, acryl · cromo, acrílico ·  
 cromo, acrílico · crom, acrílic · kromi, akryyli ·  
 chrom, akryl · krom, akrilik



↑ 35 cm, Ø 12,5 cm  
 incl. SMD-LED, 6 W  
 600 lm, 3.000 K



576410806



↑ 28 cm, ↔ 30 cm  
 incl. SMD-LED, 18 W  
 1.600 lm, 3.000 K



576491806



↔ 60 x 15,5 cm, ↓ 6 cm  
 incl. SMD-LED, 24 W  
 2.200 lm, 3.000 K



676412406



↔ 110 x 16 cm, ↑ 11 cm  
 incl. SMD-LED, 32 W  
 3.000 lm, 3.000 K

676413606



# SEVILLA

chrom, Acryl mit Kristalleffekt · chrome, broken glass optic ·  
 chrome, optique verre pilé · chroom, Gebroken glas optiek ·  
 cromo, Efecto cristal roto · cromo, effetto ottico vetro rotto ·  
 crom, aspect de sticla sparta · kromi, lasi efekti optiikka ·  
 chrom, Optyczne rozbite szkło · krom, Çatlatma cam

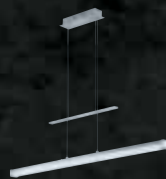

↔ 115 x 7,5 cm, ↑ 95 - 160 cm  
 incl. SMD-LED, 28 W  
 3.000 lm, 3.000 + 5.000 K

↑ 45,5 cm, ↔ 15 x 15 cm  
 incl. SMD-LED, 9,5 W  
 800 lm, 3.000 + 5.000 K

↑ 117 cm, ↔ 23 x 23 cm  
 incl. SMD-LED, 28 W  
 3.000 lm, 3.000 + 5.000 K



370090106



570090106

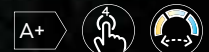

470090106

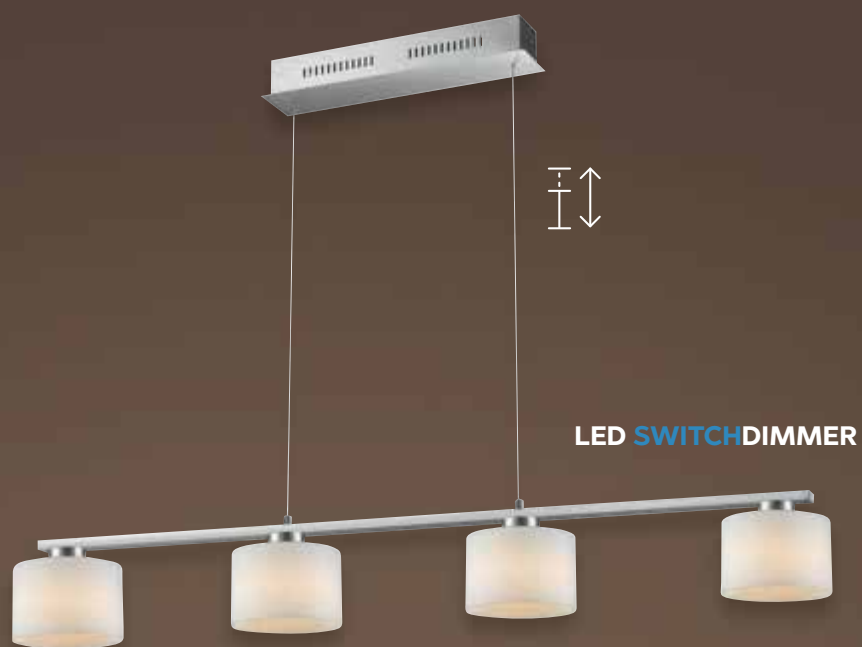

# ALEGRO

Nickel matt, Glas opal · nickel mat, opal glass ·  
 nickel mat, verre opale · nikkell mat, opaal glas ·  
 níquel mate, vidrio opal · nichel opaco, vetro opale ·  
 nichel mat, sticla opala · harjattu teräs, opaalilasi ·  
 nikiel mat, szkło opal · mat nikel, opal cam

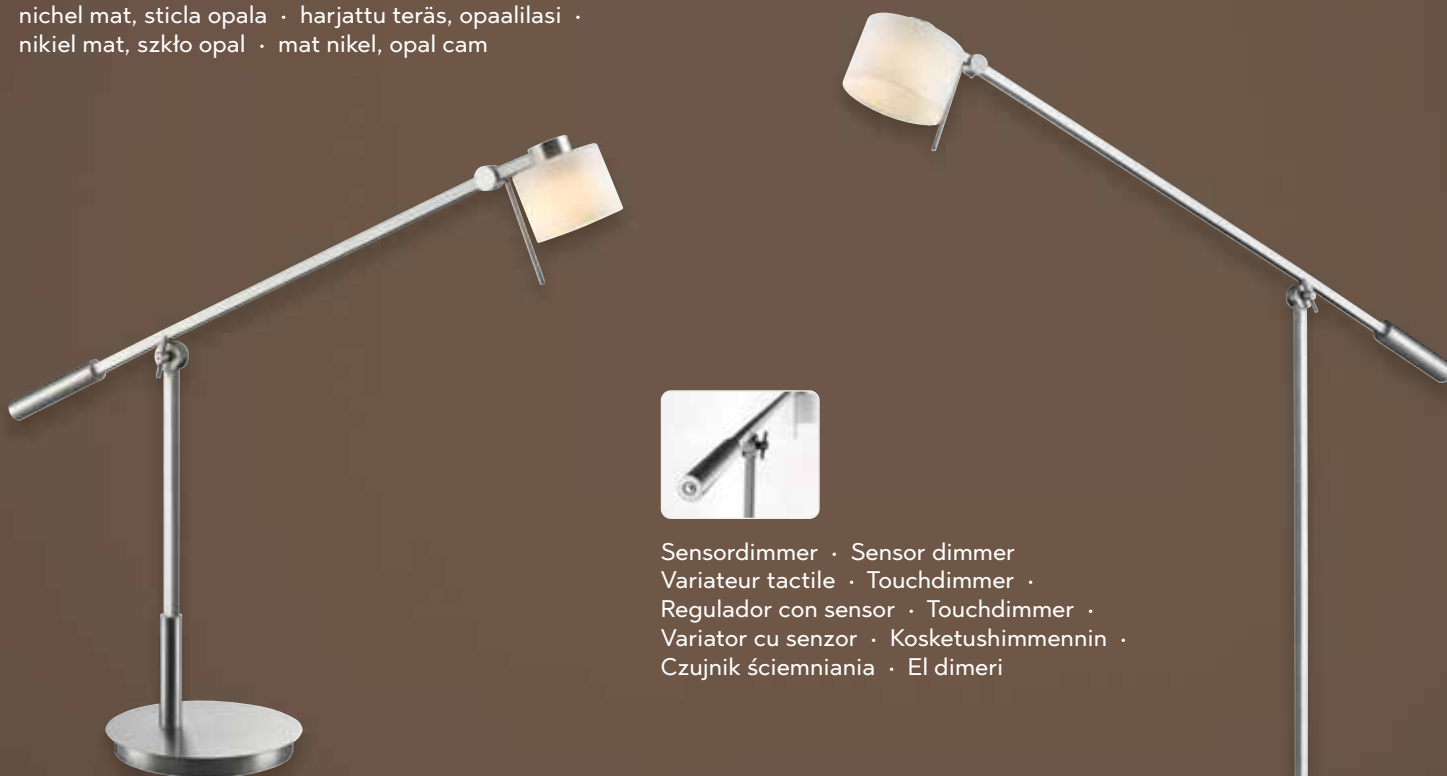

Sensordimmer · Sensor dimmer ·  
 Variateur tactile · Touchdimmer ·  
 Regulador con sensor · Touchdimmer ·  
 Variator cu senzor · Kosketushimmennin ·  
 Czujnik ściemniania · El dimeri

100



↔ 100 cm, ↑ 95 - 160 cm  
 incl. 4 x SMD-LED, 6 W  
 4 x 630 lm, 3.000 K



325510407



↔ 130 cm, ↑ 95 - 160 cm  
 incl. 5 x SMD-LED, 6 W  
 5 x 630 lm, 3.000 K



325510507



↑ max. 74 cm, ↗ 61 cm  
 incl. 1 x SMD-LED, 6 W  
 630 lm, 3.000 K



525510107



↑ max. 137 cm, ↗ 77 cm  
 incl. 1 x SMD-LED, 6 W  
 630 lm, 3.000 K



425510107

LED SWITCHDIMMER

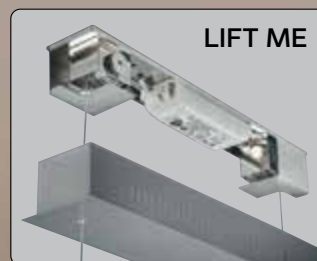

LIFT ME

Innovative Höhenverstellung ohne Gegengewicht · Innovative height adjustment without counterweight · Nouveau! Réglage de la hauteur sans contrepoids · Innovatieve hoogteverstelling zonder contragewicht · Innovador sistema de ajuste de altura sin necesidad de contrapeso · Regolazione innovativa dell'altezza senza contrappeso · Ajustare inovativa a înaltimeii fara contragreutate · Innovatiivinen korkeuden säätö ilman vastapainoa · Innowacyjna regulacja wysokości bez przeciwwagi · Yenilikçi ve ağırlıksız yükseklik ayarlayıcı

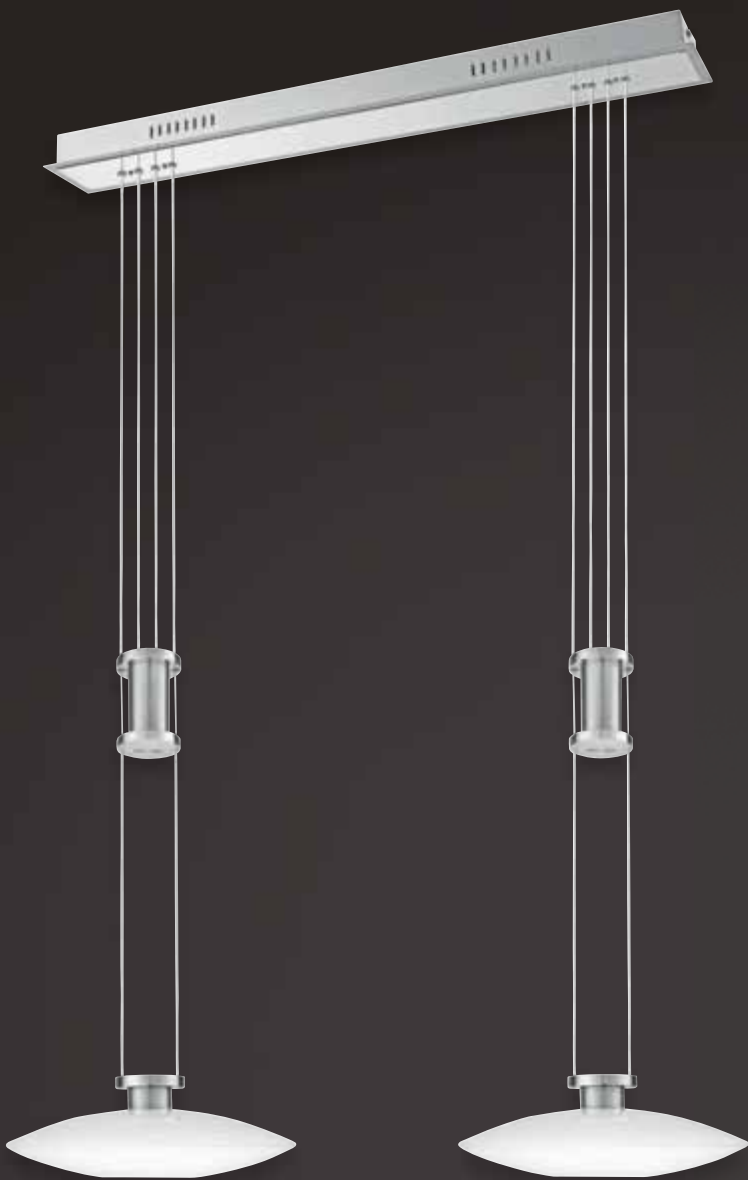

## ELINA

Nickel matt / chrom, Glas opal · nickel mat / chrome, opal glass ·  
 nickel mat / chrome, verre opale · nikkell mat / chroom, opaal glas ·  
 níquel mate / cromo, vidrio opal · nichel opaco / cromo, vetro opale ·  
 nichel mat / crom, sticla opala · harjattu teräs / kromi, opaalilasi ·  
 nikiel mat / chrom, szkło opal · mat nikel / krom, opal cam

102



↔ 67 cm, ↑ 95 - 160 cm  
 incl. 2 x SMD-LED, 6,5 W  
 2 x 650 lm, 3.000 K



325310207



∅ 51 cm, ↑ 95 - 160 cm  
 incl. 3 x SMD-LED, 6,5 W  
 3 x 650 lm, 3.000 K



325330307



↑ 145 cm, ↗ 55 cm  
 incl. 1 x SMD-LED, 6 W  
 550 lm, 3.000 K



425310107





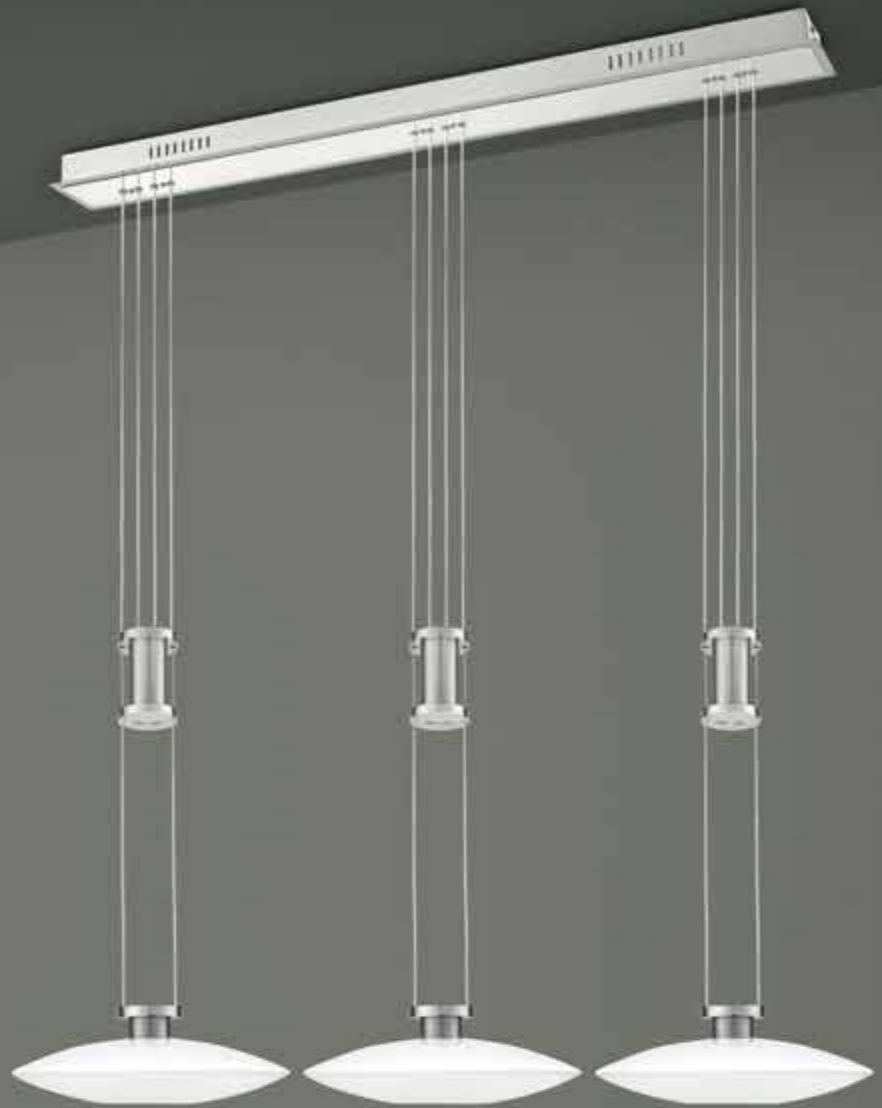

Ø 42,5 cm, ↑ 95 - 160 cm  
incl. 1 x SMD-LED, 34 W  
3.600 lm, 3.000 K



325310107



↔ 93 cm, ↑ 95 - 160 cm  
incl. 3 x SMD-LED, 6,5 W  
3 x 650 lm, 3.000 K



325310307



↑ 184 cm, ↗ 60 cm  
incl. 1 x SMD-LED, 34 W  
3.500 lm, 3.000 K  
incl. 1 x SMD, 6 W  
550 lm, 3.000 K



425310207





## ELINA

Nickel matt / chrom, Glas opal · nickel mat / chrome, opal glass ·  
nickel mat / chrome, verre opale · nikkell mat / chrom, opaal glas ·  
níquel mate / cromo, vidrio opal · nichel opaco / cromo, vetro opale ·  
nichel mat / crom, sticla opala · harjattu teräs / kromi, opaalilasi ·  
nikiel mat / chrom, szkło opal · mat nikel / krom, opal cam

## LED SWITCHDIMMER



106



Ø 11 cm, √ 17,5 cm  
incl. SMD-LED, 7,2 W  
576 lm, 3.000 K



225410207  
225410208



↑ 150 cm, Ø 25 cm  
incl. 3 x SMD-LED, 7,2 W  
3 x 576 lm, 3.000 K



425410607  
425410608



**07** Nickel matt · nickel mat  
**08** Messing matt · brass mat

LED SWITCHDIMMER

## LEICESTER

Nickel matt oder Messing matt · nickel mat or brass mat ·  
nickel mat ou laiton mat · nikkel mat of messing mat · níquel mate o bronze mate ·  
nichel opaco o ottone satinato · nichel mat sau bronz mat · harjattu teräs tai mattamessinki ·  
nikiel mat lub mosiądz mat · mat nikel veya mat piring

107

↔ 100 x 17,5 cm, ↑ 150 cm  
incl. 4 x SMD-LED, 7,2 W  
4 x 576 lm, 3.000 K



325410807  
325410808



07 Nickel matt · nickel mat  
08 Messing matt · brass mat

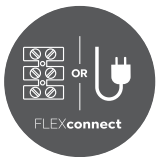

Seite/page 629



## KAZAN

Nickel matt oder schwarz matt · nickel mat or black mat ·  
 nickel mat ou noir mat · nikkell mat of mat zwart ·  
 níquel mate o estera negra · nichel opaco o nero opaco ·  
 nichel mat sau negru mat · harjattu teräs tai musta matto ·  
 nikiel mat lub czarny mat · mat nikel veya siyah mat



Ø 14 cm, √ max. 55 cm  
 incl. 1 x SMD, 8 W  
 800 lm, 3.000 K



274770107  
 274770132



↑ 46 cm, Ø 17 cm, √ max. 53 cm  
 incl. 1 x SMD, 8 W  
 800 lm, 3.000 K



574790107  
 574790132



↑ 120 cm, Ø 24 cm, √ max. 61 cm  
 incl. 1 x SMD, 8 W  
 800 lm, 3.000 K



474790107  
 474790132



**07** Nickel matt · nickel mat  
**32** schwarz matt · black mat



32



# CALCIO

Nickel matt oder Messing matt · nickel mat or brass mat · nickel mat ou laiton mat · nikkel mat of messing mat · níquel mate o bronze mate · nichel opaco o ottone satinato · nichel mat sau bronz mat · harjattu teräs tai mattamessinki · nikiel mat lub mosiądz mat · mat nikel veya mat piringç



08



07



Ø 16 cm, √ max. 63 cm  
incl. 1 x SMD-LED, 6 W  
560 lm, 3.000 K



272470107  
272470108



∫ 43 cm, √ 50 cm  
incl. 1 x SMD-LED, 6 W  
560 lm, 3.000 K



572410107  
572410108



∫ 120 - 140 cm, √ max. 71 cm  
incl. 1 x SMD-LED, 10 W  
1.000 lm, 3.000 K



422410107  
422410108



07 Nickel matt · nickel mat  
08 Messing matt · brass mat



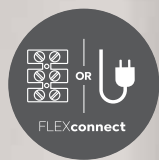

Seite/page 629

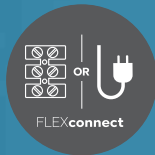

Seite/page 629



Ø 12 cm, √ max. 51 cm  
incl. 1 x SMD, 8,5 W  
830 lm, 3.000 K



275190131



↑ 49 cm, √ max. 57 cm  
incl. 1 x SMD, 8,5 W  
830 lm, 3.000 K



575190131



↑ 120 - 150 cm, √ max. 60 cm  
incl. 1 x SMD, 8,5 W  
830 lm, 3.000 K



475190131

# TENTO

Metall, weiß matt · metal, white mat ·  
metale, blanc mat · metaal, wit mat · metal, estera blanca ·  
metallo, bianco opaco · metal, alb mat · metalli, valkoinen matto ·  
metal, biały mat · metal, beyaz mat





## DUKE

Nickel matt, chrom · nickel mat, chrome ·  
 nickel mat, chrome · nikkell mat, chrom · níquel mate, cromo ·  
 nichel opaco, cromo · nichel mat, crom · harjattu teräs, kromi ·  
 nikiel mat, chrom · mat nikel, krom



Ø 16 cm,, ↗ 15 cm  
 incl. 1 x SMD-LED, 4,3 W  
 400 lm, 3.000 K



872170107



↔ 36,5 cm, ↑ 18 cm  
 incl. 2 x SMD-LED, 4,3 W  
 2 x 400 lm, 3.000 K



872110207



↔ 52,5 cm, ↑ 18 cm  
 incl. 3 x SMD-LED, 4,3 W  
 3 x 400 lm, 3.000 K



872110307



↔ 83 cm, ↑ 18 cm  
 incl. 4 x SMD-LED, 4,3 W  
 4 x 400 lm, 3.000 K



872110407



↓ 43 cm, ↔ 29 cm  
 incl. 2 x SMD-LED, 4,3 W  
 2 x 400 lm, 3.000 K



572110207



↑ 140 cm, ↔ 29 cm  
incl. 3 x SMD-LED, 4,3 W  
3 x 400 lm, 3.000 K



472110307



↔ 90 cm, ↑ 95 - 150 cm  
incl. 5 x SMD-LED, 4,3 W  
5 x 400 lm, 3.000 K



372110507



LED SWITCHDIMMER



LED SWITCHDIMMER

# LENTIL

chrom · chrome ·  
chrome · chroom · cromo ·  
cromo · crom · kromi ·  
chrom · krom



↔ 32 x 7,5 cm, ↗ 13,5 cm  
incl. 4 x SMD-LED, 2,3 W  
4 x 240 lm, 3.000 K



272570406



↔ 45 x 7,5 cm, ↗ 13,5 cm  
incl. 6 x SMD-LED, 2,3 W  
6 x 240 lm, 3.000 K



272570606



↔ 55 x 7,5 cm, ↗ 13,5 cm  
incl. 8 x SMD-LED, 2,3 W  
8 x 240 lm, 3.000 K



272510806



↔ 73 x 34,5 cm, ↑ 22 cm  
incl. 10 x SMD-LED, 2,3 W  
10 x 240 lm, 3.000 K



672511006



↔ 80 x 21 cm, ↑ 95 - 160 cm  
incl. 8 x SMD-LED, 2,3 W  
8 x 240 lm, 3.000 K



372510806



Farblinsen separat erhaltlich ·  
Color lenses separately available ·  
Lentilles de couleur disponibles s par ment ·  
Verschillende kleurlenze speeraat leverbaar ·  
Lentes de colores disponibles por separado ·  
Filtri colorati venduti separatamente ·  
Lentile colorate disponibile ·  
V rilinssit saatavilla erikseen ·  
Soczewki kolorowe dost pne osobno ·  
Renk mercekleri ayrı olarak

Product No. **92805**



↑ 12,5 x 7,5 cm,   13,5 cm  
incl. 2 x SMD-LED, 2,3 W  
2 x 240 lm, 3.000 K

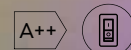

**272570206**



Ø 30 cm, ↓ 150 cm  
incl. SMD-LED, 30 W  
2.650 lm, 3.000 K

↓ 180 cm, ↔ 65 cm  
incl. SMD-LED, 30 W  
2.650 lm, 3.000 K



**376110106**  
**376110131**

**476110106**

**06** chrom · chrome  
**31** weiß matt · white mat



# BALLOON

chrom oder weiß matt · chrome or white mat ·  
chrome ou blanc mat · chrom of wit mat · cromo o estera blanca ·  
cromo o bianco opaco · crom sau alb mat · kromi tai valkoinen matto ·  
chrom lub biały mat · krom veya beyaz mat

**LED SWITCHDIMMER**



LED SWITCHDIMMER

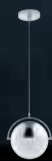

Ø 25 cm, ↑ 150 cm  
incl. SMD-LED, 22 W  
2.000 lm, 3.000 K



378310106



↑ 180 cm, ↗ 52 cm  
incl. 1 x SMD-LED, 22 W , 2.000 lm, 3.000 K  
incl. 1 x SMD-LED, 3,8 W , 350 lm, 3.000 K



478310206



↑ 200 cm, ↗ 61 cm  
incl. 5 x SMD-LED, 3,8 W  
5 x 350 lm, 3.000 K



478310506

# CHRIS

chrom, Acryl mit Kristalleffekt · chrome, broken glass optic ·  
chrome, optique verre pilé · chrom, gebroken glas optiek · cromo, efecto cristal roto ·  
cromo, effetto ottico vetro rotto · crom, aspect de sticla sparta · kromi, lasi efekti optiikka ·  
chrom, optyczne rozbite szkło · krom, çatlatma cam

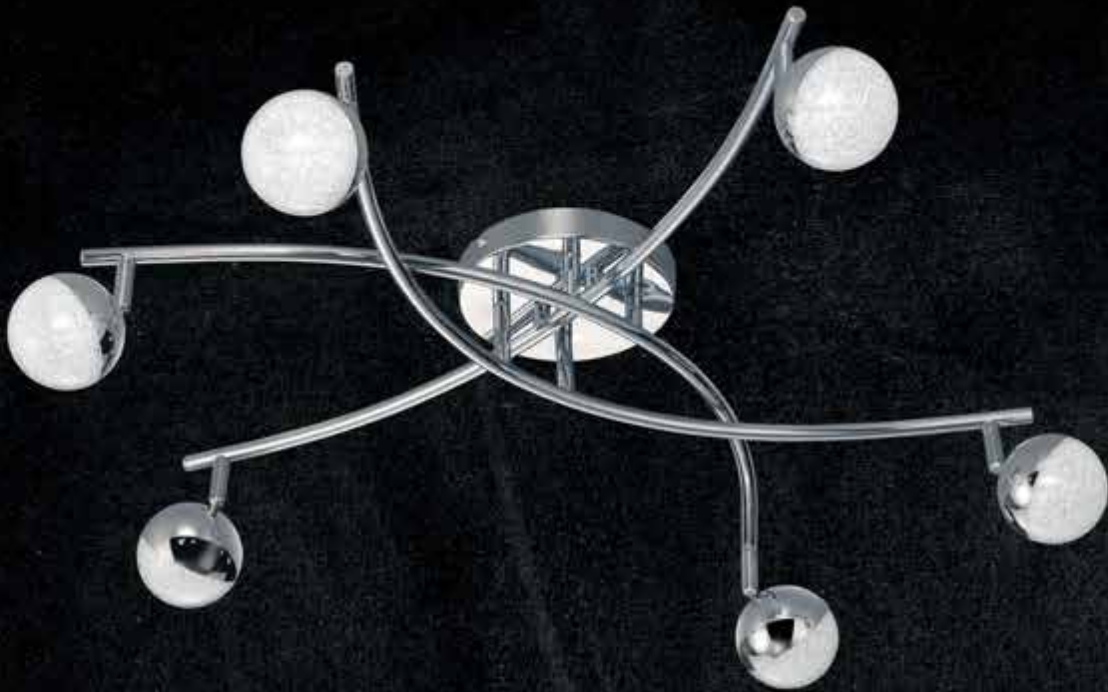

↔ 12,5 cm, ↗ 13,5 cm  
incl. 1 x SMD-LED, 3,8 W  
350 lm, 3.000 K



878310106



↔ 33,5 cm, ↑ 15 cm  
incl. 2 x SMD-LED, 3,8 W  
2 x 350 lm, 3.000 K



878310206



↔ 50 cm, ↑ 15 cm  
incl. 3 x SMD-LED, 3,8 W  
3 x 350 lm, 3.000 K



878310306



↔ 75 cm, ↑ 15 cm  
incl. 4 x SMD-LED, 3,8 W  
4 x 350 lm, 3.000 K



878310406



Ø 71 cm, ↑ 21 cm  
incl. 6 x SMD-LED, 3,8 W  
6 x 350 lm, 3.000 K



678310606

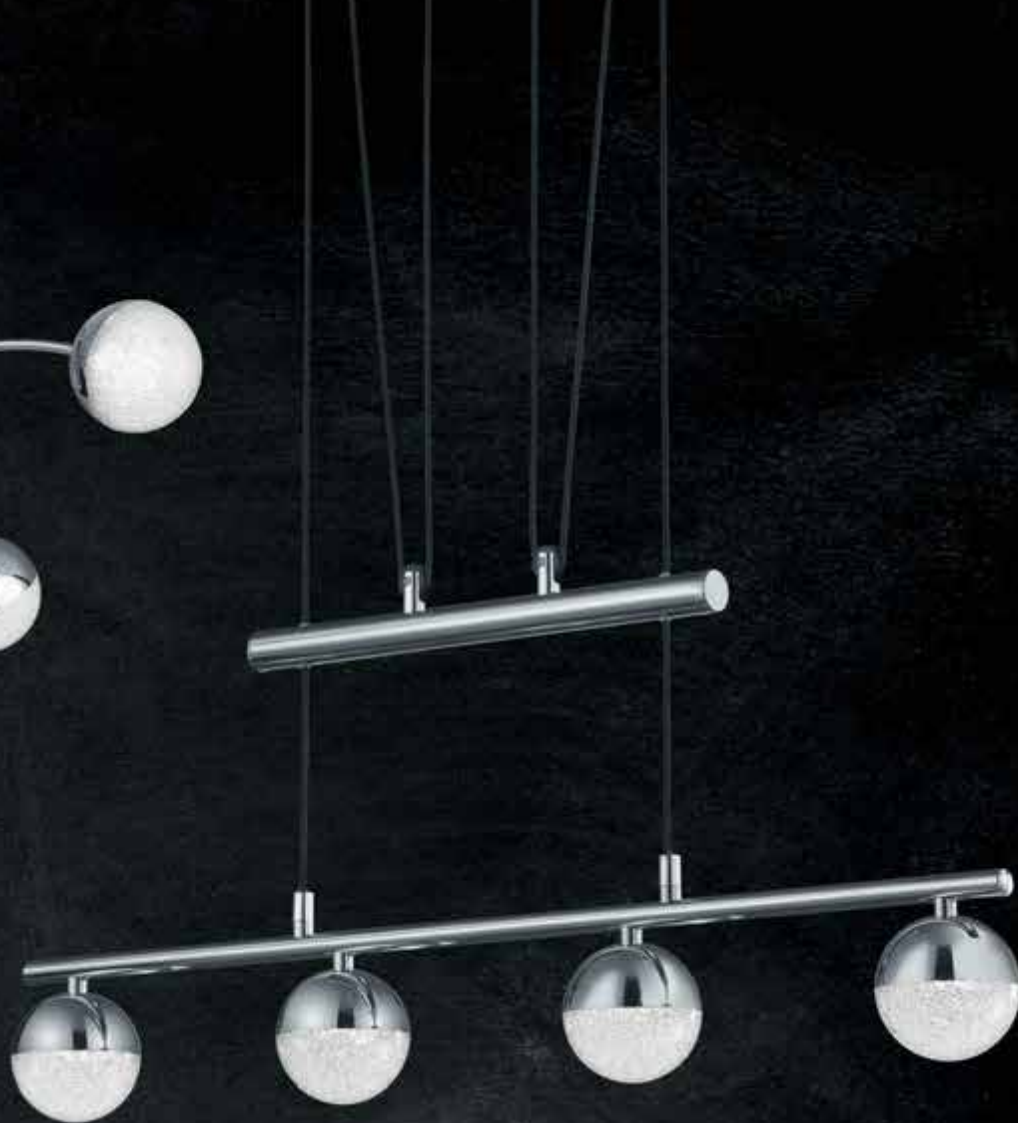

## CHRIS

chrom, Acryl mit Kristalleffekt · chrome, broken glass optic ·  
 chrome, optique verre pilé · chrom, gebroken glas optiek ·  
 cromo, efecto cristal roto · cromo, effetto ottico vetro rotto ·  
 crom, aspect de sticla sparta · kromi, lasi efekti optiikka ·  
 chrom, optyczne rozbite szkło · krom, çatlatma cam



↔ 57 x 34,5 cm, ↓ 20,5 cm  
 incl. 5 x SMD-LED, 3,8 W  
 5 x 350 lm, 3.000 K

A+

678310506



Ø 44 cm, ↓ 18 cm  
 incl. 3 x SMD-LED, 3,8 W  
 3 x 350 lm, 3.000 K

A+

678310306



↔ 74,5 cm, ↓ 95 - 150 cm  
 incl. 4 x SMD-LED, 3,8 W  
 4 x 350 lm, 3.000 K



378310406



↓ 29,5 cm, ↗ 21 cm  
 incl. 1 x SMD-LED, 3,8 W  
 350 lm, 3.000 K



578310106



## THUNDER

Aluminiumgeflecht · aluminium meshwork ·  
 maillage aluminium · aluminium vlechtwerk ·  
 malla de aluminio · reticolo alluminio ·  
 impletitura aluminu · alumiiniverkko ·  
 aluminium koronka · alüminyum örgü



Ø 20 cm  
 incl. SMD-LED, 4 W  
 370 lm, 3.000 K



525112005



Ø 30 cm  
 incl. SMD-LED, 8 W  
 650 lm, 3.000 K



525113005

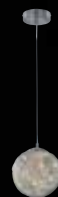

Ø 30 cm, ↑ 150 cm  
incl. SMD-LED, 8 W  
650 lm, 3.000 K



325113005



Ø 40 cm, ↑ 150 cm  
incl. SMD-LED, 10,5 W  
800 lm, 3.000 K



325114005



## DOUGLAS

Metall, chrom · metal, chrome ·  
metale, chrome · metaal, chroom · metal, cromo · metallo, cromo ·  
metal, crom · metalli, kromi · metal, chrom · metal, krom

Empfohlen:  
recommended: LED G9, 3 W  
300 lm, 3.000 K



**929-2300 2er Blister**

126

Ø 70 cm, ↑ 33 cm  
excl. 4 x G9, max. 28 W



**605800406**

Ø 70 cm, ↑ 150 cm  
excl. 5 x G9, max. 28 W

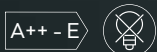

**305800506**









# ARBUSTOS

Aluminiumgeflecht · aluminium meshwork ·  
 maillage aluminium · aluminium vlechtwerk · malla de aluminio ·  
 reticolo alluminio · impletitura aluminii · alumiiniverkko ·  
 aluminium koronka · alüminyum örgü

Empfohlen:

recommended: LED G9, 3,5 W  
 300 lm, 3.000 K



A+

**929-235 2er Blister**



Ø 50 cm, ↓ 42 cm  
 excl. 5 x G9, max. 33 W



**611300506**



Ø 50 cm, ↓ max. 253 cm  
 excl. 6 x G9, max. 33 W



**311300606**



Ø 60 cm, ↓ max. 263 cm  
 excl. 8 x G9, max. 33 W



**311300806**



Ø 22 cm, ↓ 40 cm  
 excl. 3 x G9, max. 33 W



**511300306**



Ø 30 cm, ↓ 130 cm  
 excl. 6 x G9, max. 33 W



**411300606**





Ø 40 cm, ↑ 24 cm  
excl. 5 x G9, max. 42 W

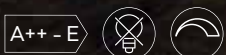

611210506



Ø 40 cm, ↑ 150 cm  
excl. 5 x G9, max. 42 W



311210506



Ø 50 cm, ↑ 150 cm  
excl. 6 x G9, max. 42 W



311210606



Ø 28 cm, ↑ 43 cm  
excl. 3 x G9, max. 42 W



511210306

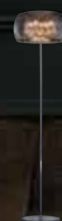

Ø 40 cm, ↑ 160 cm  
excl. 4 x G9, max. 42 W



411210406



## VAPORE

chrom, Glas chrom bedampft · chrome, chroom plated glass ·  
chrome, verre plaqué chrome · chroom, chroom opgedampt glas ·  
cromo, vidrio cromado · cromo, vetro verniciato cromo ·  
crom, sticla cromata · kromi, kromipäällystetty lasi ·  
chrom, szkło chromowane · krom, krom kaplama cam





# MADEIRA

Glas schwarz, innen goldfarbig · glass black, gold colored inside ·  
 verre noir, Or · glas zwart, Binnenkant goudkleur · vidrio negro, Interior en color dorado ·  
 vetro nero, interno colore oro · sticla negru, interior culoare aurie · lasi musta, sisäosa kullanvärinen ·  
 szkło czarny, wewnątrz złoty · cam siyah, altın iç kaplama



↓ 45 cm, ↔ 18 cm, ↗ 19,5 cm  
 excl. 1 x E14, max. 40 W

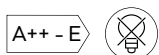

210200102



Ø 30 cm, ↓ 150 cm  
 excl. 1 x E27, max. 60 W

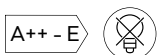

310200102



Ø 48 cm, ↓ 150 cm  
 excl. 1 x E27, max. 60 W

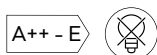

310290102





↑ 45 cm, ↔ 18 cm, ∠ 19,5 cm  
excl. 1 x E14, max. 40 W



210200101



∅ 30 cm, ↑ 150 cm  
excl. 1 x E27, max. 60 W



310200101



∅ 48 cm, ↑ 150 cm  
excl. 1 x E27, max. 60 W



310290101

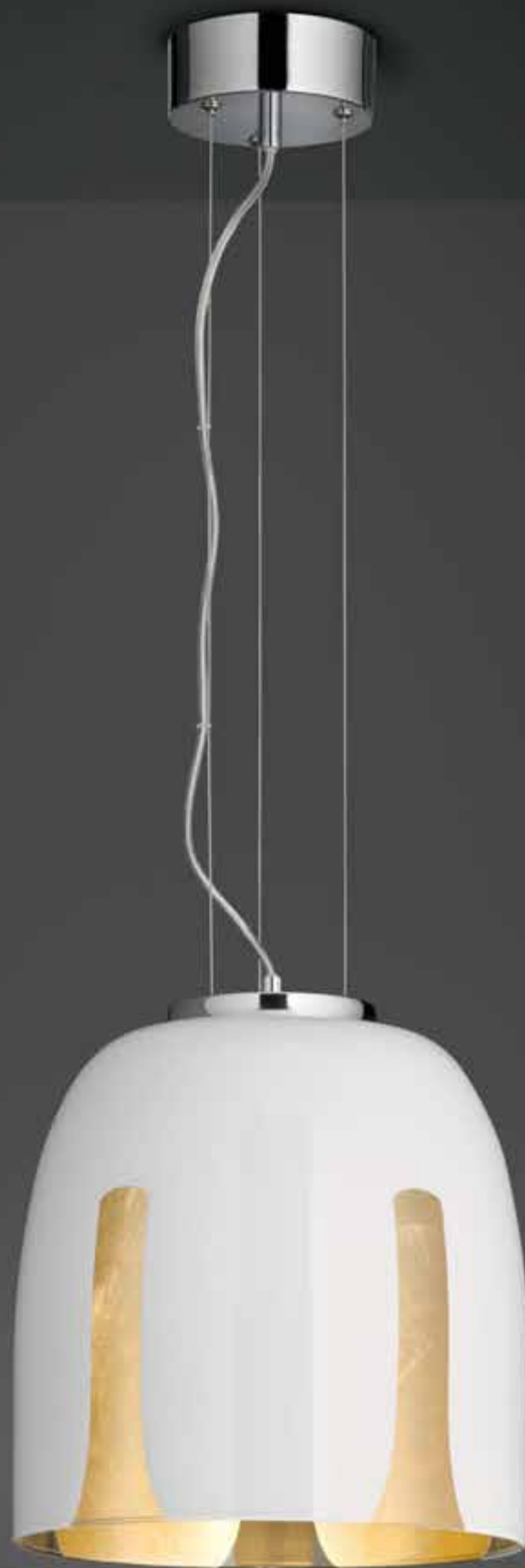





## MADEIRA

Glas weiß, innen goldfarbig · glass white, gold colored inside ·  
verre blanc, Or · glas wit, Binnenkant goudkleur ·  
vidrio blanco, Interior en color dorado · vetro bianco, interno colore oro ·  
sticla alb, interior culoare aurie · lasi valkoinen, sisäosa kullanvärinen ·  
szkło biały, wewnątrz złoty · cam beyaz, altın iç kaplama





## FARO

chrom, Glas schwarz matt, innen goldfarbig · chrome, glass black mat, gold colored inside ·  
chrome, verre noir mat, Or · chroom, glas mat zwart, Binnenkant goudkleur ·  
cromo, vidrio estera negra, Interior en color dorado · cromo, vetro nero opaco, interno colore oro ·  
crom, sticla negru mat, interior culoare aurie · kromi, lasi musta matto, sisäosa kullanvärinen ·  
chrom, szkło czarny mat, wewnątrz złoty · krom, cam siyah mat, altın iç kaplama



136



Ø 40 cm, ↓ 17,5 cm  
excl. 2 x E14, max. 60 W

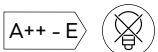

606100232



Ø 50 cm, ↓ 21 cm  
excl. 3 x E27, max. 60 W

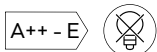

606100332





Ø 30 cm  
excl. 1 x E14, max. 40 W



506100132



Ø 50 cm  
excl. 1 x E27, max. 60 W



506190132



Ø 30 cm, ↓ 150 cm  
excl. 1 x E27, max. 60 W



306100132



Ø 50 cm, ↓ 150 cm  
excl. 1 x E27, max. 60 W



306190132

# FARO

chrom, Glas weiß matt, innen goldfarbig · chrome, glass white mat, gold colored inside ·  
 chrome, verre blanc mat, Or · chrom, glas wit mat, Binnenkant goudkleur ·  
 cromo, vidrio estera blanca, Interior en color dorado · cromo, vetro bianco opaco, interno colore oro ·  
 crom, sticla alb mat, interior culoare aurie · kromi, lasi valkoinen matto, sisäosa kullanvärinen ·  
 chrom, szkło biały mat, wewnątrz złoty · krom, cam beyaz mat, altın iç kaplama



Ø 30 cm  
 excl. 1 x E14, max. 40 W



506100131



Ø 50 cm  
 excl. 1 x E27, max. 60 W



506190131



Ø 30 cm, ↑ 150 cm  
 excl. 1 x E27, max. 60 W



306100131



Ø 50 cm, ↑ 150 cm  
 excl. 1 x E27, max. 60 W



306190131

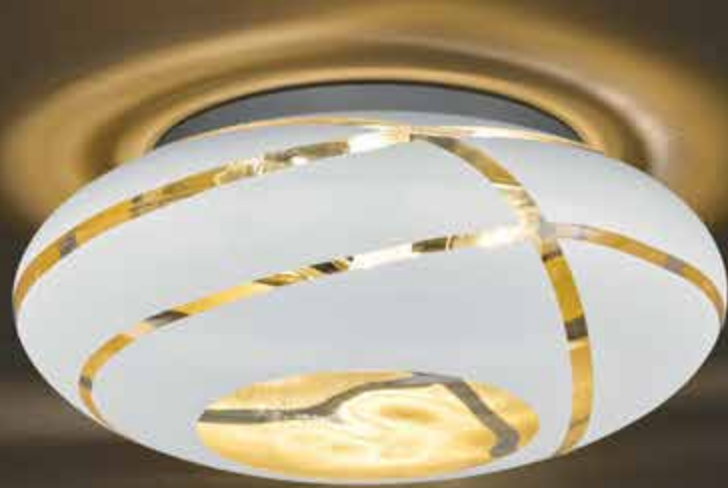

Ø 40 cm, ↑ 17,5 cm  
excl. 2 x E27, max. 60 W

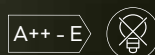

606100231

Ø 50 cm, ↑ 21 cm  
excl. 3 x E27, max. 60 W



606100331

32



## PORTO

Glas, rauchfarbig oder amber · glass, smoke or amber ·  
 verre, fumé ou ambre · glas, rookkleur of amber · vidrio, humo o ámbar · vetro, fume' o ambra ·  
 sticla, fumuriu sau amber · lasi, savu tai meripihka · szkło, przydymiony lub bursztynowy · cam, duman veyá amber



Ø 39,5 cm, ↑ 20 cm  
 excl. 1 x E14, max. 40 W

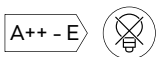

508800131  
 508800132



Ø 39,5 cm, ↑ 130 cm  
 excl. 1 x E27, max. 60 W

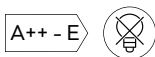

308800131  
 308800132



Ø 55 cm, ↑ 136 cm  
 excl. 1 x E27, max. 60 W

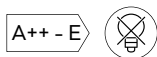

308890131  
 308890132



31 weiß matt · white mat  
 32 schwarz matt · black mat





# KINGSTON

Glas, chrom · glass, chrome ·  
verre, chrome · glas, chrom · vidrio, cromo ·  
vetro, cromo · sticla, crom · lasi, kromi ·  
szkło, chrom · cam, krom



142



↓ 150 cm, Ø 35 cm  
excl. 1 x E27, max. 60 W

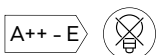

315300106



↓ 150 cm, Ø 20 cm  
excl. 1 x E14, max. 40 W

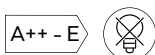

315390106



↓ 30,5 cm, Ø 20 cm  
excl. 1 x E14, max. 40 W



515300106

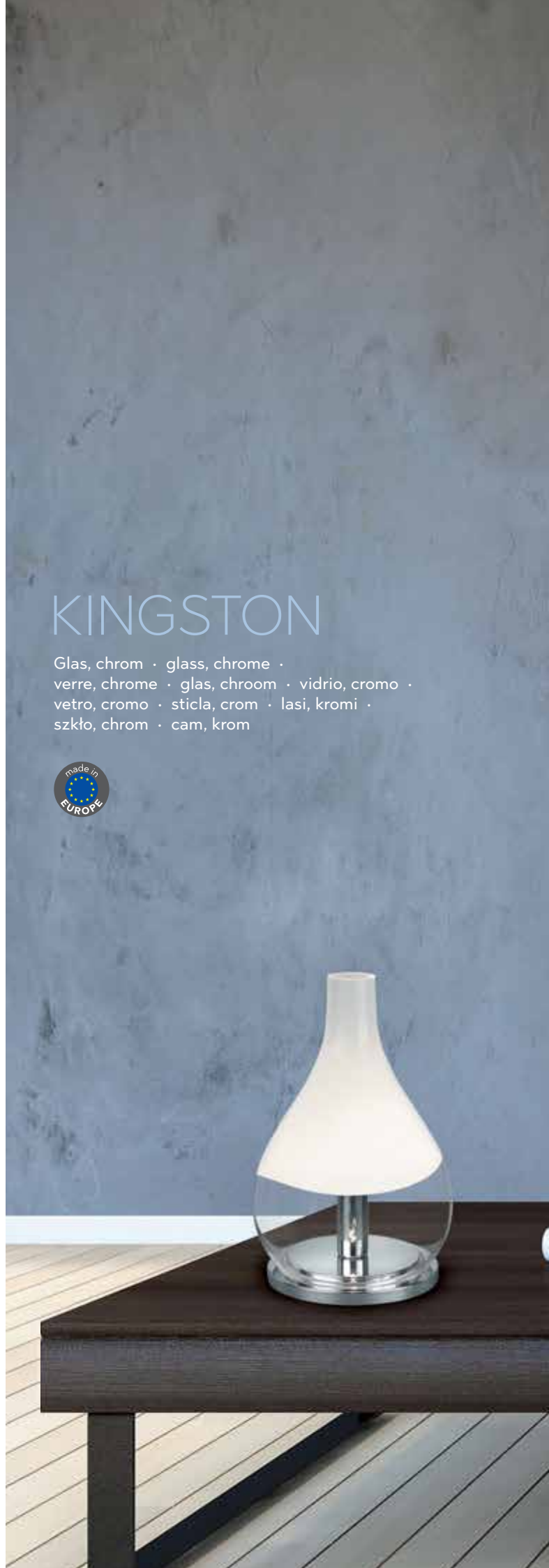





89

09



144



↑ 155 cm, Ø 51 cm  
excl. 1 x E27, max. 60 W

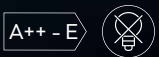

315200109  
315200179  
315200189



09 kupferfarbig · copper  
79 goldfarbig · gold  
89 silberfarbig · silver



## ONTARIO

Glas goldfarbig, silberfarbig oder kupferfarbig · glass gold, silver or copper ·  
verre or, argent ou cuivré · glas goud, zilver of koperkleurig ·  
vidrio oro, plata o color cobre · vetro oro, argento o colore rame ·  
sticla aur, argint sau cupru · lasi kultaa, hopea tai kuperinvärinen ·  
szkło złota, srebrny lub kolorze miedzi · cam altın, gümüş veya bakır renkli





## ONTARIO

Glas goldfarbig oder silberfarbig · glass gold or silver ·  
 verre or ou argent · glas goud of zilver · vidrio oro o plata ·  
 vetro oro o argento · sticla aur sau argint · lasi kultaa tai hopea ·  
 szkło złota lub srebrny · cam altın veya gümüş



↓ 150 cm, Ø 33 cm  
 excl. 1 x E27, max. 60 W

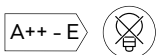

**305200179**  
**305200189**



↓ 150 cm, Ø 18 cm  
 excl. 1 x E14, max. 40 W

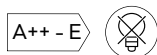

**305290179**  
**305290189**



↔ 80 x 18 cm, ↓ 150 cm  
 excl. 3 x E14, max. 40 W

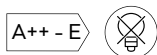

**305200379**  
**305200389**



**79** goldfarbig · gold  
**89** silberfarbig · silver



07



## MIDAS

Glas matt weiß oder Rauchglas · mat glass white or smoked glass · verre mat blanc ou verre fumé · mat glas wit of rookglas · vidrio mate blanco o vidrio ahumado · vetro sabbiato bianco o vetro fume' · sticla mata alb sau sticla fumurie · mattalasi valkoinen tai savulasi · szkło matowane biały lub szkło przydymione · mat cam beyaz veya puslu cam

148



Ø 30 cm  
excl. 1 x E27, max. 60 W

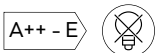

501600106  
501600107



Ø 30 cm, ↑ 150 cm  
excl. 1 x E27, max. 60 W

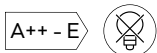

301600106  
301600107



Ø 45 cm, ↑ 150 cm  
excl. 1 x E27, max. 60 W

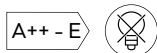

301690106  
301690107



06 chrom · chrome  
07 Nickel matt · nickel mat



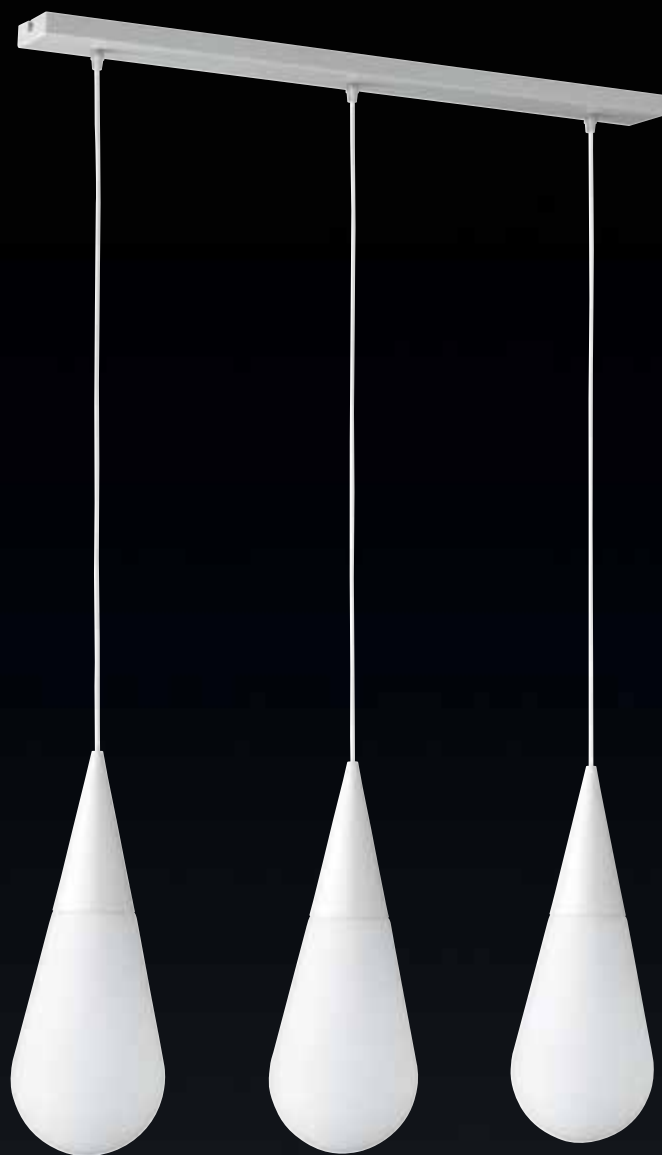

## TOULON

Metall, Glas matt · metal, mat glass ·  
metale, verre mat · metaal, mat glas · metal, vidrio mate · metallo, vetro sabbato ·  
metal, sticla mata · metalli, mattalasi · metal, szkło matowane · metal, mat cam

150



↓ 150 cm, Ø 23 cm  
excl. 1 x E27, max. 60 W

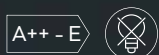

304790101



↓ 150 cm, Ø 17 cm  
excl. 1 x E27, max. 60 W



304700101



↔ 80 x 17 cm, ↓ 120 cm  
excl. 3 x E27, max. 60 W

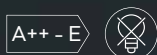

304700301



↔ 13 cm, ↓ 44 cm, ↗ 13 cm  
excl. 1 x E27, max. 60 W

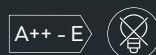

204700101







LED SWITCHDIMMER

# MOSAIQUE

Glas Mosaik · glass mosaic ·  
verre mosaïque · glas mozaiek · vidrio mosaico ·  
vetro mosaico · stilca mozaic · lasi mosaiikki ·  
szkło mozaika · cam mozaik



Ø 20 cm  
excl. 1 x E14, max. 40 W



503000189



Ø 40 cm, ↓ 10 cm  
incl. SMD-LED, 24 W  
2.120 lm, 3.000 K



673012489



Ø 50 cm, ↓ 13 cm  
incl. SMD-LED, 30 W  
2.650 lm, 3.000 K

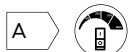

673013089



Ø 30 cm, ↓ 150 cm  
excl. 1 x E27, max. 60 W

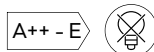

303000189

# HAMILTON

Glas Marmor · glass marble ·  
verre marbre · glas marmer · vidrio mármol ·  
vetro marmo · stilca marmura · lasi marmori ·  
szkło marmur · can mermer



Ø 20 cm  
excl. 1 x E14, max. 28 W



506700106



Ø 39 cm, ↓ 150 cm  
excl. 1 x E27, max. 60 W

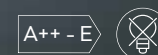

306700106



## GINELLI

Nickel matt, Glas matt · nickel mat, mat glass ·  
 nickel mat, verre mat · nikkel mat, mat glas ·  
 níquel mate, vidrio mate · nichel opaco, vetro sabbato ·  
 nichel mat, sticla mata · harjattu teräs, mattalasi ·  
 nikiel mat, szkło matowane · mat nikel, mat cam



↓ 20 x 14 cm, ↗ 20 cm  
 excl. 1 x E14, max. 28 W

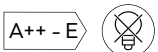

801500107



↔ 44 x 12 cm, ↓ 22 cm  
 excl. 2 x E14, max. 28 W

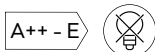

801500207



↔ 60 x 12 cm, ↓ 22 cm  
 excl. 3 x E14, max. 28 W

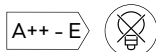

801500307



↔ 80 x 12 cm, ↓ 22 cm  
 excl. 4 x E14, max. 28 W

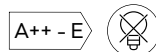

801500407



↔ 90 x 48 cm, ↓ 24 cm  
 excl. 5 x E14, max. 28 W



601500507



↔ 70 x 12 cm, ↓ 150 cm  
excl. 4 x E14, max. 28 W



301500407

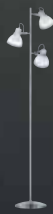

↓ 150 cm, ↔ 37 cm  
excl. 3 x E14, max. 28 W



401500307



04

Empfohlen:  
recommended: LED E14, 6 W  
470 lm, 3.000 K



A+

983-60



07



∅ 9 cm, ↗ 17 cm  
excl. 1 x E14, max. 40 W

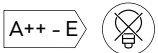

803100104  
803100107



↔ 26 cm, ↓ 19,5 cm  
excl. 2 x E14, max. 40 W

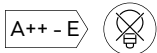

803100204  
803100207



↔ 41 cm, ↓ 19,5 cm  
excl. 3 x E14, max. 40 W

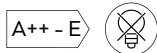

803100304  
803100307

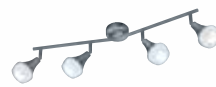

↔ 68 cm, ↓ 19,5 cm  
excl. 4 x E14, max. 40 W



803100404  
803100407



## TRUMPET

Nickel matt oder altmessing, Glas matt · nickel mat or old brass, mat glass ·  
 nickel mat ou laiton fumé, verre mat · nikkell mat of oud brons, mat glas ·  
 níquel mate o bronce viejo, vidrio mate · nichel opaco o ottone invecchiato, vetro sabbiato ·  
 nichel mat sau bronz antic, sticla mata · harjattu teräs tai antiikkimessinki, mattalasi ·  
 nikiel mat lub patyna, szkło matowane · mat nikel veyá antik pirinç, mat cam

157



↓ 40,5 cm, ↗ 34 cm  
 excl. 1 x E14, max. 40 W



503100104  
 503100107



↓ 145 cm, ↗ 39 cm  
 excl. 1 x E14, max. 40 W



403100104  
 403100107



Ø 30 cm, ↓ 150 cm  
 excl. 1 x E27, max. 60 W

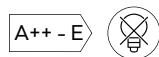

303100104  
 303100107



**04** altmessing · old brass  
**07** Nickel matt · nickel mat

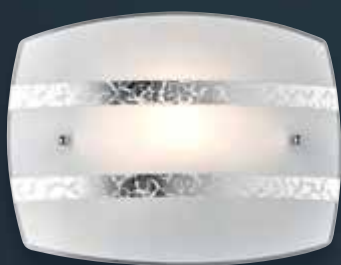
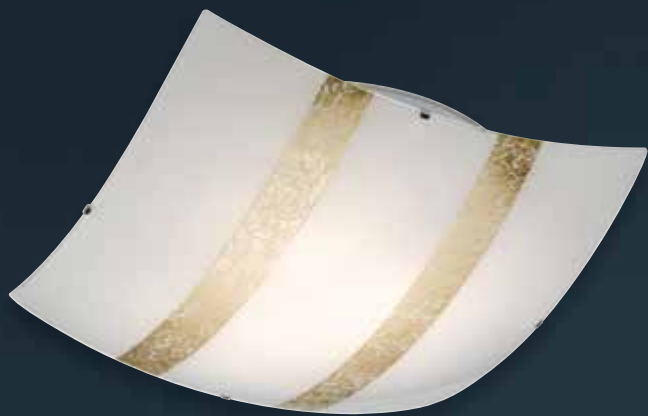

# NIKOSIA

Dekorglas · glas decorated · verre décoré · decoratief glas · vidrio decorado · vetro decorato · sticla decorativa · ornamenttilasi · szkło dekoracyjne · dekoratif cam



↔ 30 x 22 cm, ↗ 7,5 cm  
excl. 1 x E27, max. 40 W



208700179  
208700189



↔ 30 x 30 cm, ↑ 9 cm  
excl. 1 x E27, max. 40 W



608700179  
608700189



↔ 40 x 40 cm, ↑ 9,5 cm  
excl. 2 x E27, max. 40 W

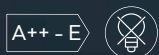

608700279  
608700289



↔ 50 x 50 cm, ↑ 11 cm  
excl. 3 x E27, max. 40 W



608700379  
608700389



↔ 50 x 20 cm, ↑ 150 cm  
excl. 2 x E27, max. 40 W



308700279  
308700289



89



159



Ø 14 cm, ↓ 150 cm  
excl. 1 x E27, max. 40 W



308700179  
308700189



↔ 80 cm, ↓ 150 cm  
excl. 3 x E27, max. 40 W

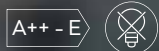

308700379  
308700389



79 goldfarbig · gold  
89 silberfarbig · silver



↔ 30 x 15 cm, ↗ 9 cm  
excl. 1 x E27, max. 40 W



207700100

∅ 30 cm, ↑ 9 cm  
excl. 1 x E27, max. 40 W



607700100

∅ 40 cm, ↑ 10 cm  
excl. 2 x E27, max. 40 W



607700200

∅ 50 cm, ↑ 13 cm  
excl. 3 x E27, max. 40 W



607700300

∅ 50 cm, ↑ 150 cm  
excl. 3 x E27, max. 40 W



307700300



## CHRISTOBAL

chrom, Dekorglas weiß · chrome, glas decorated white ·  
chrome, verre décoré blanc · chroom, decoratief glas wit · cromo, vidrio decorado blanco ·  
cromo, vetro decorato bianco · crom, sticla decorativa alb · kromi, ornamenttilasi valkoinen ·  
chrom, szkło dekoracyjne biały · krom, dekoratif cam beyaz

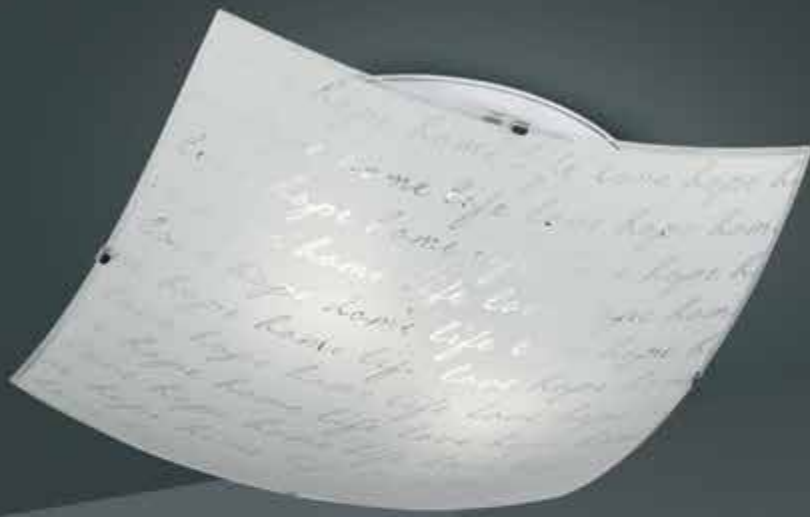

# SIGNA

chrom, Dekorglas weiß · chrome, glas decorated white ·  
 chrome, verre décoré blanc · chroom, decoratief glas wit ·  
 cromo, vidrio decorado blanco · cromo, vetro decorato bianco ·  
 crom, sticla decorativa alb · kromi, ornamenttilasi valkoinen ·  
 chrom, szkło dekoracyjne biały · krom, dekoratif cam beyaz



↔ 20 x 30 cm, ↑ 9 cm  
 excl. 1 x E27, max. 40 W



202500101



↔ 30 x 30 cm, ↑ 9 cm  
 excl. 1 x E27, max. 40 W



602500101



↔ 40 x 40 cm, ↑ 9,5 cm  
 excl. 2 x E27, max. 40 W



602500201



↔ 50 x 50 cm, ↑ 11 cm  
 excl. 3 x E27, max. 40 W



602500301



Ø 50 cm, ↑ 150 cm  
 excl. 3 x E27, max. 40 W



302500301

# SPIRELLI

chrom, Dekorglas weiß · chrome, glas decorated white ·  
 chrome, verre décoré blanc · chroom, decoratief glas wit ·  
 cromo, vidrio decorado blanco · cromo, vetro decorato bianco ·  
 crom, sticla decorativa alb · kromi, ornamenttilasi valkoinen ·  
 chrom, szkło dekoracyjne biały · krom, dekoratif cam beyaz



↔ 30 x 22 cm, ↗ 7,5 cm  
 excl. 1 x E27, max. 40 W



204400101



↔ 30 x 30 cm, ↑ 9 cm  
 excl. 1 x E27, max. 40 W



604400101



↔ 40 x 40 cm, ↑ 9,5 cm  
 excl. 2 x E27, max. 40 W



604400201



↔ 50 x 50 cm, ↑ 11 cm  
 excl. 3 x E27, max. 40 W



604400301



↔ 40 x 20 cm, ↑ 150 cm  
 excl. 2 x E27, max. 40 W



304400201



## EDISON

Nickel matt, Glas matt · nickel mat, mat glass ·  
nickel mat, verre mat · nikkell mat, mat glas ·  
níquel mate, vidrio mate · nichel opaco, vetro sabbato ·  
nichel mat, sticla mata · harjattu teräs, mattalasi ·  
nikiel mat, szkło matowane · mat nikel, mat cam



Ø 24,5 cm, ↓ 200 cm  
excl. 1 x E27, max. 60 W

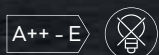

3401011-07



↓ 179 cm, Ø 24,5 cm  
excl. 1 x E27, max. 60 W

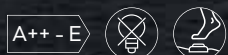

4601011-07



↓ 43 cm, Ø 15 cm  
excl. 1 x E14, max. 40 W



5601011-07

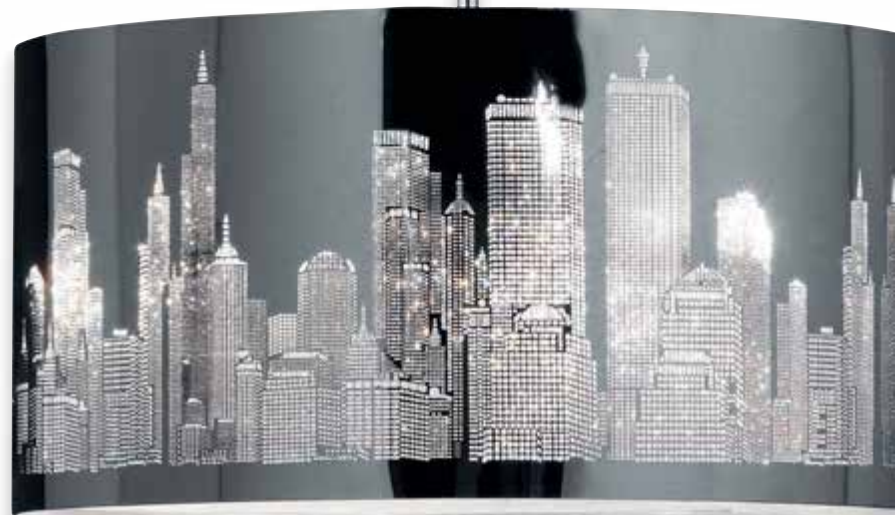
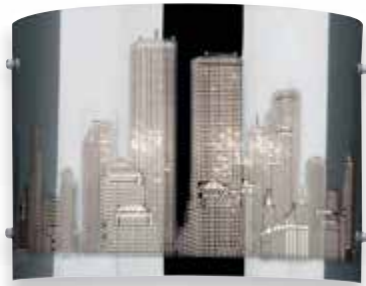

## CAPITAL

Metall, chrom · metal, chrome ·  
 metale, chrome · metaal, chroom · metal, cromo ·  
 metallo, cromo · metal, crom · metalli, kromi ·  
 metal, chrom · metal, krom

165



↔ 22 cm, ↓ 17 cm, ↗ 11 cm  
 excl. 1 x E14, max. 40 W

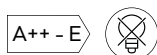

208400106



↓ 130 cm, Ø 40 cm  
 excl. 2 x E14, max. 40 W

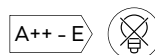

308400206



↓ 40 cm, Ø 12 cm  
 excl. 1 x E14, max. 40 W



598400106



## SWEETY

Acryl · acryl ·  
acryl · acryl · acrílico · acrilico ·  
acrylic · akryyli · akryl · akrilik



Ø 29 cm, ↓ 150 cm  
excl. 1 x E27, max. 60 W

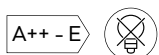

307900100



Ø 30 cm, ↓ 150 cm  
excl. 1 x E27, max. 60 W

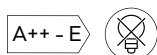

307800100



Ø 40 cm, ↓ 150 cm  
excl. 1 x E27, max. 60 W

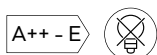

307804100



↓ 23 cm, Ø 25 cm  
excl. 1 x E14, max. 40 W



507800100



↔ 20 x 20 cm, ↗ 9 cm  
excl. 1 x E14, max. 40 W

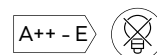

207800100





Ø 30 cm, ↑ 10,5 cm  
excl. 1 x E27, max. 60 W



607800100



32

## DISCALGO

Metall, Kunststoff · metal, plastic ·  
 metale, plastique · metaal, kunststof ·  
 metal, plástico · metallo, plastica ·  
 metal, plastic · metalli, muovi ·  
 metal, plastik · metal, plastik



168



Ø 54 cm, ↑ 30 cm  
 excl. 3 x E14, max. 40 W



609900331  
 609900332



Ø 54 cm, ↑ 150 cm  
 excl. 6 x E14, max. 40 W



309900631  
 309900632



31 weiß matt · white mat  
 32 schwarz matt · black mat





## NACHO

Metall schwarz matt/bronzefarbig, Glas klar · metal black mat/bronze, clear glass ·  
 metale noir mat/bronze, verre claire · metaal mat zwart/bronze, helder glas ·  
 metal estera negra/bronze, vidrio claro · metallo nero opaco/bronzo, vetro chiaro ·  
 metal negru mat/bronz, sticlă transparentă · metalli musta matto/pronssi, kirkas lasi ·  
 metal czarny mat/brąz, przezroczyste szkło · metal siyah mat/tunç, şeffaf



↑ 38,5 x 12 cm, ↗ 16 cm  
 excl. 1 x E14, max. 28 W



200800132



Ø 57 cm, ↑ 45 cm  
 excl. 5 x E14, max. 28 W



600800532



Ø 61 cm, ↑ 150 cm  
 excl. 6 x E14, max. 28 W



100800632



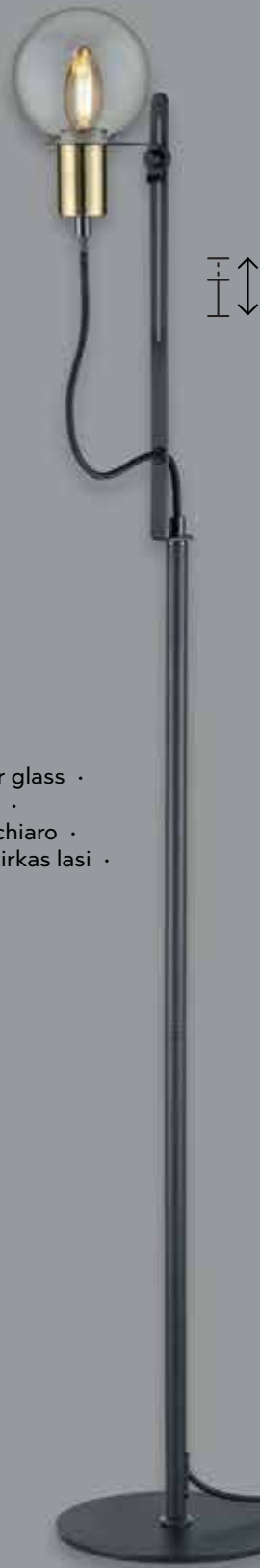

# NACHO

Metall schwarz matt/bronzefarbig, Glas klar · metal black mat/bronze, clear glass ·  
 metale noir mat/bronze, verre claire · metaal mat zwart/bronze, helder glas ·  
 metal estera negra/bronze, vidrio claro · metallo nero opaco/bronzo, vetro chiaro ·  
 metal negru mat/bronz, sticlă transparentă · metalli musta matto/pronssi, kirkas lasi ·  
 metal czarny mat/brąz, przezroczyste szkło · metal siyah mat/tunç, şeffaf

Empfohlen:  
 recommended: Filament LED E14, 4 W  
 470 lm, 3.000 K



**989-4470**



Ø 12 cm, ↓ 120 cm  
 excl. 1 x E14, max. 28 W

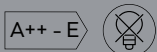

**300800132**



↔ 90 x 12 cm, ↓ 150 cm  
 excl. 4 x E14, max. 28 W



**300800432**



↓ 47 cm, ↔ 16 cm, ↗ 25 cm  
 excl. 1 x E14, max. 28 W



**500800132**



↓ 140 cm, ↔ 22 cm, ↗ 29 cm  
 excl. 1 x E14, max. 28 W



**400800132**





# CROSS

Metall, schwarz matt / goldfarbig · metal, black mat / gold ·  
 metale, noir mat / or · metaal, mat zwart / goud ·  
 metal, estera negra / oro · metallo, nero opaco / oro ·  
 metal, negru mat / aur · metalli, musta matto / kultaa ·  
 metal, czarny mat / złota · metal, siyah mat / altın

Empfohlen:

recommended: LED E27, 6 W  
 420 lm, 2.700 K



A+

988-679



Ø 57 cm, ↓ 19 cm  
 excl. 6 x E27, max. 40 W



606700632



↓ 101 x 56 cm, ↔ 150 cm  
 excl. 7 x E27, max. 28 W

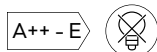

306700732



Ø 54,5 cm, ↓ 150 cm  
 excl. 6 x E27, max. 28 W



306700632



↓ 165 cm, Ø 55 cm  
 excl. 6 x E27, max. 28 W



406700632







31

32

## DAKOTA

Metall, weiß matt oder schwarz matt · metal, white mat or black mat ·  
 metale, blanc mat ou noir mat · metaal, wit mat of mat zwart ·  
 metal, estera blanca o estera negra · metallo, bianco opaco o nero opaco ·  
 metal, alb mat sau negru mat · metalli, valkoinen matto tai musta matto ·  
 metal, biały mat lub czarny mat · metal, beyaz mat veya siyah mat

Empfohlen:  
 recommended: LED G9, 3 W  
 300 lm, 3.000 K



929-2300 2er Blister

↓ 20 x 10 cm, ↗ 13 cm  
 excl. 1 x G9, max. 28 W



804670131  
 804670132

↔ 40 x 20 cm, ↓ 13 cm  
 excl. 2 x G9, max. 28 W



804670231  
 804670232

↔ 60 x 25 cm, ↓ 13 cm  
 excl. 3 x G9, max. 28 W

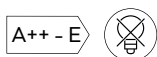

804600331  
 804600332

↔ 80 x 30 cm, ↓ 13 cm  
 excl. 4 x G9, max. 28 W

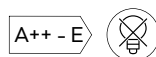

804600431  
 804600432

∅ 50 cm, ↓ 13 cm  
 excl. 5 x G9, max. 28 W

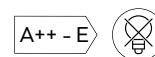

604600531  
 604600532



↔ 80 x 30 cm, ↑ 150 cm  
excl. 5 x G9, max. 28 W



304600531  
304600532

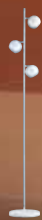

↑ 155 cm, ↔ 23 cm  
excl. 3 x G9, max. 28 W



404600331  
404600332



31 weiß matt · white mat  
32 schwarz matt · black mat

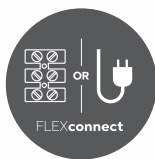

Seite/page 629



Ø 12 cm, ↗ 50 cm  
excl. 1 x E14, max. 28 W



208870131  
208870132



Ø 80 cm, ↑ 26 cm  
excl. 6 x E14, max. 28 W

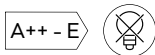

608800631  
608800632



Ø 80 cm, ↑ 150 cm  
excl. 6 x E14, max. 28 W

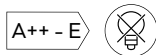

118800631  
118800632



↑ 160 cm, ↔ 38 cm  
excl. 3 x E14, max. 28 W



408800331  
408800332



**31** weiß matt · white mat  
**32** schwarz matt · black mat



## EDWARD

Metall · metal ·  
metale · metaal · metal · metallo ·  
metal · metalli · metal · metal

Empfohlen:  
recommended: Filament LED E14, max. 4 W  
470 lm, 2.700 K



A++



983-4470



02



## LORELEY

chrom, Acryl, Stoffschirm · chrome, acryl, fabric shade ·  
chrome, acryl, abat-jour tissu · chrom, acryl, Stoffen kap ·  
cromo, acrílico, Pantalla de tela · cromo, acrilico, paralume in tessuto ·  
chrom, acrilic, abajur textil · kromi, akryyli, kangas varjostin ·  
chrom, akryl, Klosz z materiału · krom, akrilik, Kumaş şapka



180



↓ 51 cm, Ø 30 cm  
excl. 2 x E14, max. 40 W



509300201  
509300202



Ø 50 cm, ↓ 150 cm  
excl. 3 x E14, max. 40 W

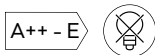

309300301  
309300302



01 weiß · white  
02 schwarz · black

01





32



31

# BARON

Metall, Acryl · metal, acryl ·  
metale, acryl · metaal, acryl · metal, acrílico · metallo, acrilico ·  
metal, acrilic · metalli, akryyli · metal, akryl · metal, akrilik

182



Ø 52 cm, ↑ 24 cm  
excl. 4 x E27, max. 40 W

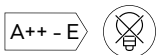

609800431  
609800432



Ø 52 cm, ↑ 150 cm  
excl. 4 x E27, max. 40 W

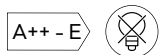

309800431  
309800432



31 weiß matt · white mat  
32 schwarz matt · black mat





# RODNEY

Beton grau · concrete grey ·  
béton gris · beton grijs · hormigón gris · cemento grigio ·  
beton gri · betoni harmaa · beton popielaty · beton gri



↓ 150 cm, Ø 17,5 cm  
excl. 1 x E14, max. 40 W

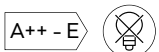

306100178



↔ 85 x 17,5 cm, ↓ 150 cm  
excl. 3 x E27, max. 60 W

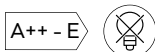

306100378



↓ 38 cm, Ø 25 cm  
excl. 1 x E14, max. 40 W



506100178



↓ 51 cm, Ø 30 cm  
excl. 1 x E27, max. 60 W



506190178







09



04



07

# JASPER

Metall · metal ·  
metale · metaal · metal · metallo ·  
metal · metalli · metal · metal

187



Ø 31 cm, ↓ 150 cm  
excl. 1 x E27, max. 60 W

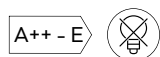

300500104  
300500107  
300500109



↓ 45 cm, ↗ 23 cm  
excl. 1 x E14, max. 40 W



500500104  
500500107  
500500109



↓ 140 cm, ↗ 52 cm  
excl. 1 x E14, max. 40 W



400500104  
400500107  
400500109



**04** altmessing · old brass  
**07** nickel matt · matt nickel  
**09** kupferfarbig · copper



## VEGAS

Metall, Acryl · metal, acryl ·  
 metale, acryl · metaal, acryl · metal, acrílico ·  
 metallo, acrilico · metal, acrylic · metalli, akryyli ·  
 metal, akryl · metal, akrilik



Ø 50 cm, ↑ 27 cm  
 excl. 3 x E27, max. 42 W

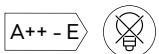

**606000307**  
**606000331**  
**606000332**



Ø 50 cm, ↑ 150 cm  
 excl. 1 x E27, max. 42 W

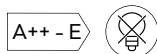

**306000107**  
**306000131**  
**306000132**



**07** Nickel matt · nickel mat  
**31** weiß matt · white mat  
**32** schwarz matt · black mat





↔ 40 x 36,5 cm, ↗ 21 cm  
excl. 2 x E14, max. 28 W

∅ 50 cm, ↑ 50 cm  
excl. 4 x E14, max. 28 W

∅ 52 cm, ↑ 150 cm  
excl. 4 x E14, max. 28 W

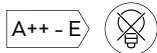
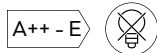

210370206  
210370228

610300406  
610300428

110300406  
110300428



06 chrom · chrome  
28 rostfarbig antik · antique rust





## NAPOLI

Metall mit Acrylapplikationen · metal with acrylic decoration ·  
m tal avec d coration acrylique · Metaal met acryl decoraties ·  
Metal con decoraci n en acr lico · metallo con decorazione in acrilico ·  
metal cu decoratie acrilica · metaalia, jossa akryyli koristeet ·  
Metal z aplikacjami akrylowym · akrilik g r n ml  metal

Empfohlen:  
recommended: Filament LED E14, 4 W  
400 lm, 3.000 K



A++

989-400





↓ 29 cm, ↔ 28 cm, ↗ 18 cm  
excl. 2 x E14, max. 40 W

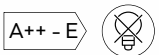

210500228  
210500261



Ø 47 cm, ↓ 150 cm  
excl. 3 x E14, max. 40 W

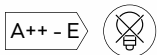

110500328  
110500361



Ø 57 cm, ↓ 150 cm  
excl. 5 x E14, max. 40 W

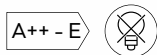

110500528  
110500561



**28** rostfarbig antik · antique rust  
**61** grau antik · antique grey



## CLASSY

Metall mit Acrylapplikationen ·  
 metal with acrylic decoration ·  
 métal avec décoration acrylique ·  
 Metaal met acryl decoraties ·  
 Metal con decoración en acrílico ·  
 metallo con decorazione in acrilico ·  
 metal cu decoratie acrilica ·  
 metaalia, jossa akryyli koristeet ·  
 Metal z aplikacjami akrylowym ·  
 akrilik görünümlü metal

Empfohlen:  
 recommended: Filament LED E14, 5 W  
 400 lm, 3.000 K



A++

990-400





## TRADITIO

Metall, Glas alabasterfarbig · metal, alabaster-coloured glass ·  
 metale, verre couleur albâtre · metaal, albastkleurig glas · metal, vidrio de color alabastro ·  
 metallo, vetro colore alabastro · metal, sticla culoare alabastru · metalli, lasi alabasteri väri ·  
 metal, szkło alabaster kolor · metal, cam kaymaktaşı rengi

194



↔ 21,5 x 13 cm, ↗ 29 cm  
 excl. 1 x E14, max. 40 W

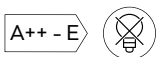

**200700128**  
**200700161**



↓ 32 cm, ↗ 27 cm  
 excl. 1 x E14, max. 40 W



**500700128**  
**500700161**



Ø 70 cm, ↓ 150 cm  
 excl. 3 x E14, max. 40 W

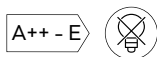

**110700328**  
**110700361**



Ø 70 cm, ↓ 150 cm  
 excl. 5 x E14, max. 40 W

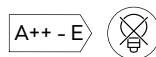

**110700528**  
**110700561**



Ø 61 cm, ↓ 26 cm  
 excl. 3 x E14, max. 40 W

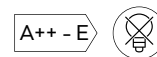

**600700328**  
**600700361**



**28** rostfarbig antik · antique rust  
**61** grau antik · antique grey



## RUSTICA

rostfarbig, Glas matt · rusty, mat glass ·  
rouille, verre mat · roestkleur, mat glas ·  
óxido, vidrio mate · ruggine, vetro sabbiato ·  
ruginiu, sticla mata · rustiikki, mattalasi ·  
miedź, szkło matowane · pas, mat cam



↔ 83 cm, ↓ 150 cm  
excl. 2 x E27, max. 60 W

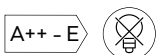

3402021-24



∅ 38 cm, ↓ 14 cm  
excl. 2 x E27, max. 60 W

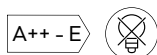

6102021-24



↓ 50 cm, ∅ 33 cm  
excl. 2 x E14, max. 40 W



5602021-24



↓ 180 cm, ∅ 32,5 cm  
excl. 1 x E27, max. 100 W  
excl. 1 x E14, max. 40 W



4602021-24



Ø 40 cm, ↑ 150 cm  
excl. 1 x E27, max. 60 W

A++ - E 

3402011-24



24

## TORNESH

Nickel matt oder rostfarbig, Glas alabasterfarbig ·  
 nickel mat or rusty, alabaster-coloured glass ·  
 nickel mat ou rouille, verre couleur albâtre ·  
 nikkell mat of roestkleur, albastkleurig glas ·  
 níquel mate o óxido, vidrio de color alabastro ·  
 nichel opaco o ruggine, vetro colore alabastro ·  
 nichel mat sau ruginiu, sticla culoare alabastru ·  
 harjattu teräs tai rustiikki, lasi alabasteri väri ·  
 nikiel mat lub miedz, szkło alabaster kolor ·  
 mat nikel veya pas, cam kaymaktaşı rengi



07



**07** Nickel matt · matt nickel  
**24** rostfarbig · rusty



↑ 54 x 14 cm, ↗ 7 cm  
 excl. 1 x G9, 28 W

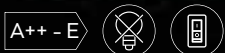

2670911-24



↑ 150 cm, Ø 26 cm  
 excl. 2 x G9, 28 W



4470921-07  
 4470921-24







# AGENTO

Nickel matt oder Messing matt, Stoff · nickel mat or brass mat, fabric · nickel mat ou laiton mat, tissu · nikkell mat of messing mat, textiel · níquel mate o bronze mate, tela · nichel opaco o ottone satinato, tessuto · nichel mat sau bronz mat, textil · harjattu teräs tai mattamessinki, tekstiili · nikiel mat lub mosiądz mat, tkanina · mat nikel veya mat piring, kumaş

## LED SWITCHDIMMER



↑ 32 cm, Ø 20 cm  
incl. 1 x SMD-LED, 7,5 W  
750 lm, 3.000 K

Ø 40 cm, ↑ 10 cm  
incl. 1 x SMD-LED, 24 W  
2.100 lm, 3.000 K

↔ 90 x 20 cm, ↑ 95 - 160 cm  
incl. 3 x SMD-LED, 7,5 W  
3 x 750 lm, 3.000 K

↔ 115 x 20 cm, ↑ 95 - 160 cm  
incl. 4 x SMD-LED, 7,5 W  
4 x 750 lm, 3.000 K



578090107  
578090108

678010107  
678010108

378010307  
378010308

378010407  
378010408

**07** Nickel matt · nickel mat  
**08** Messing matt · brass mat

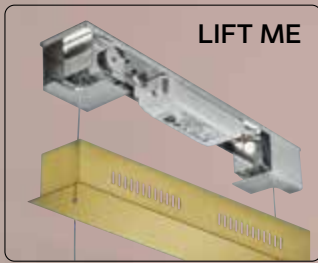

Innovative Höhenverstellung ohne Gegengewicht · Innovative height adjustment without counterweight · Nouveau! Réglage de la hauteur sans contrepoids · Innovatieve hoogteverstelling zonder contragewicht · Innovador sistema de ajuste de altura sin necesidad de contrapeso · Regolazione innovativa dell'altezza senza contrappeso · Ajustare inovativa a inaltimii fara contragreutate · Innovatiivinen korkeuden säätö ilman vastapainoa · Innowacyjna regulacja wysokości bez przeciwwagi · Yenilikçi ve ağırlıksız yükseklik ayarlayıcı



# LUGANO

Nickel matt, Stoffschirm · nickel mat, fabric shade ·  
 nickel mat, abat-jour tissu · nikkell mat, Stoffen kap ·  
 níquel mate, Pantalla de tela · nichel opaco, paralume in tessuto ·  
 nichel mat, abajur textil · harjattu teräs, kangas varjostin ·  
 nikiel mat, Klosz z materiału · mat nikel, Kumaş şapka

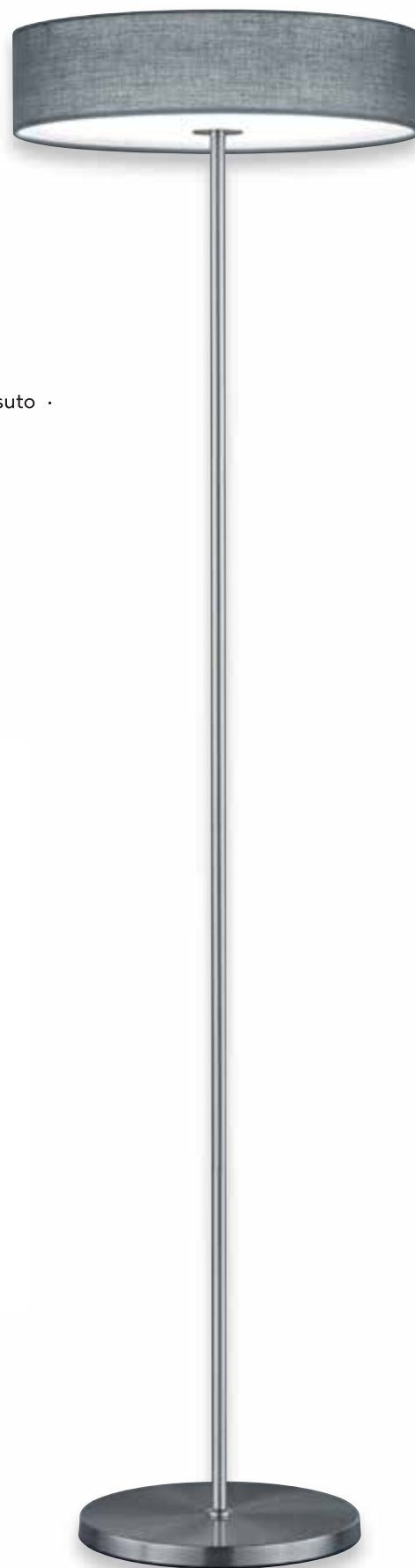

↓ 40 cm, Ø 30 cm  
 incl. SMD-LED, 12 W  
 1.100 lm, 3.000 K



571911201  
 571911211



↓ 150 cm, Ø 40 cm  
 incl. SMD-LED, 24 W  
 2.200 lm, 3.000 K

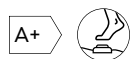

471912401  
 471912411



↔ 100 x 8,5 cm, ↓ 150 cm  
 incl. SMD-LED, 18 W  
 1.500 lm, 3.000 K

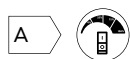

320910101  
 320910111



01 weiß · white  
 11 grau · grey

LED SWITCHDIMMER





LED SWITCHDIMMER



11



01

## LUGANO

Nickel matt, Stoffschirm · nickel mat, fabric shade ·  
nickel mat, abat-jour tissu · nikkell mat, Stoffen kap ·  
níquel mate, Pantalla de tela · nichel opaco, paralume in tessuto ·  
nichel mat, abajur textil · harjattu teräs, kangas varjostin ·  
nikkiel mat, Klosz z materiału · mat nikel, Kumaş şapka



↔ 25 x 8 cm, ↕ 7,5 cm  
incl. SMD-LED, 6 W  
580 lm, 3.000 K



271970601  
271970611



Ø 30 cm, ↓ 9 cm  
incl. SMD-LED, 11 W  
1.100 lm, 3.000 K



621911201  
621911211



Ø 40 cm, ↓ 10,5 cm  
incl. SMD-LED, 22 W  
2.200 lm, 3.000 K



621912401  
621912411



Ø 60 cm, ↓ 7,5 cm  
incl. SMD-LED, 40 W  
3.200 lm, 3.000 K



621914001  
621914011



Ø 75 cm, ↓ 7,5 cm  
incl. SMD-LED, 55 W  
4.400 lm, 3.000 K



621915501  
621915511



01 weiß · white  
11 grau · grey



LED SWITCHDIMMER

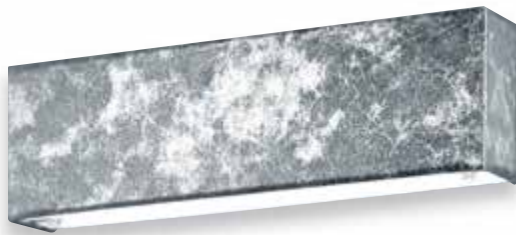

89



79

## LUGANO

Nickel matt, Schirm Kunststofffolie · nickel mat, plastic foil shade ·  
 nickel mat, abat-jour plastique transparent · nikkell mat, Kunststoff folie kap ·  
 níquel mate, Pantalla de papel de plástico · nichel opaco, paralume in materiale acrílico ·  
 nichel mat, abajur folie plastic · harjattu teräs, muovikalvo varjostin ·  
 nikiel mat, Klosz folia z plastiku · mat nikel, Plastik folyo şapka



↔ 25 x 8 cm, ↗ 7,5 cm  
 incl. SMD-LED, 6 W  
 580 lm, 3.000 K



271970679  
 271970689



Ø 30 cm, ↓ 9 cm  
 incl. SMD-LED, 11 W  
 1.100 lm, 3.000 K



621911279  
 621911289



Ø 40 cm, ↓ 10,5 cm  
 incl. SMD-LED, 22 W  
 2.200 lm, 3.000 K

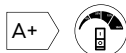

621912479  
 621912489



↔ 100 x 8,5 cm, ↑ 150 cm  
 incl. SMD-LED, 18 W  
 1.500 lm, 3.000 K

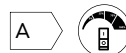

320910179  
 320910189



79 goldfarbig · gold  
 89 silberfarbig · silver





LED SWITCHDIMMER



## MERAN

Nickel matt, Stoffschirm weiß ·  
 nickel mat, fabric shade white ·  
 nickel mat, abat-jour tissu blanc ·  
 nikkell mat, Stoffen kap wit ·  
 níquel mate, Pantalla de tela blanco ·  
 nichel opaco, paralume in tessuto bianco ·  
 nichel mat, abajur textil alb ·  
 harjattu teräs, kangas varjostin valkoinen ·  
 nikiel mat, Klosz z materiału biały ·  
 mat nikel, Kumaş şapka beyaz



↓ 60 cm, Ø 18 cm, ↗ 43 cm  
 excl. 1 x E27, max. 40 W



506800107



↓ 155 cm, Ø 30 cm, ↗ 96 cm  
 excl. 1 x E27, max. 40 W



406800107



↔ 80 cm, ↓ 150 cm  
 excl. 3 x E27, max. 40 W

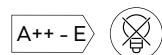

306800307





## MERAN

Nickel matt, Stoffschirm weiß · nickel mat, fabric shade white ·  
 nickel mat, abat-jour tissu blanc · nikkel mat, Stoffen kap wit ·  
 níquel mate, Pantalla de tela blanco · nichel opaco, paralume in tessuto bianco ·  
 nichel mat, abajur textil alb · harjattu teräs, kangas varjostin valkoinen ·  
 nikiel mat, Klosz z materiału biały · mat nikel, Kumaş şapka beyaz

210



↓ 32 cm, Ø 18 cm, ∠ max. 78 cm  
 excl. 1 x E27, max. 40 W



206870107



↓ 150 cm, Ø 28 cm  
 excl. 1 x E27, max. 40 W

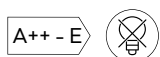

306800107



Ø 74 cm, ↓ 27 cm  
 excl. 3 x E27, max. 40 W

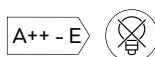

606800307

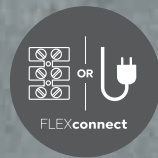

Seite/page 629

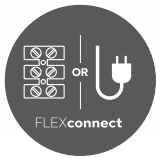

Seite/page 629

## LYON

Nickel matt oder Messing matt, Stoffschirm ·  
 nickel mat or brass mat, fabric shade ·  
 nickel mat ou laiton mat, abat-jour tissu ·  
 nikkell mat of messing mat, Stoffen kap ·  
 níquel mate o bronze mate, Pantalla de tela ·  
 nichel opaco o ottone satinato, paralume in tessuto ·  
 nichel mat sau bronz mat, abajur textil ·  
 harjattu teräs tai mattamessinki, kangas varjostin ·  
 nikiel mat lub mosiądz mat, Klosz z materiału ·  
 mat nikel veya mat pirinç, Kumaş şapka



07

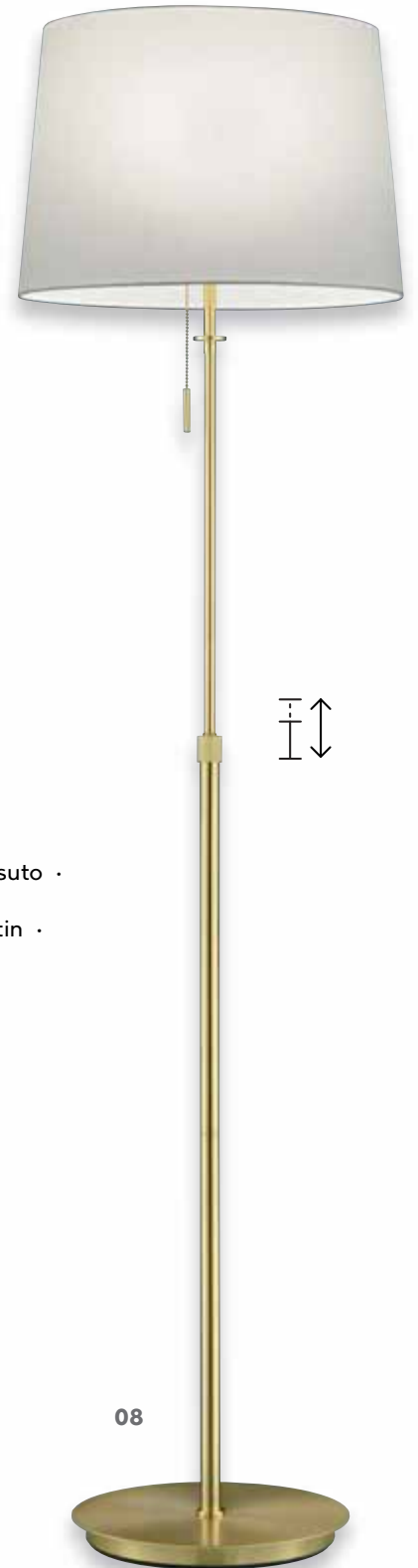

08



↓ 32 cm, ↗ 69 cm  
 excl. 1 x E27, max. 60 W



209100107  
 209100108



↓ 45 - 56 cm, Ø 25,5 cm  
 excl. 1 x E27, max. 60 W



509100107  
 509100108



↓ 138 - 180 cm, Ø 46 cm  
 excl. 3 x E27, max. 60 W

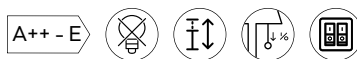

409100307  
 409100308



07 Nickel matt · nickel mat  
 08 Messing matt · brass mat



Getrennt schaltbar · Separately switchable ·  
Interrupteurs séparés · Gescheiden schakelbaar ·  
Interruptores separados · Interruttori separati ·  
Intrerupatoare separate · Erikseen kytkettäissä ·  
Oddzileny przełącznik · Dışarıdan anahtarlı









# HOTEL

Nickel matt, Stoff · nickel mat, fabric ·  
 nickel mat, tissu · nikkell mat, textiel · níquel mate, tela ·  
 nichel opaco, tessuto · nichel mat, textil · harjattu teräs, tekstiili ·  
 nikiel mat, tkanina · mat nikel, kumaş



Ø 40 cm, ↓ 150 cm  
 excl. 1 x E27, max. 60 W

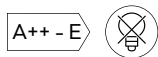

**303300101**  
**303300102**  
**303300114**



Ø 50 cm, ↓ 150 - 180 cm  
 excl. 3 x E27, max. 60 W



**303300301**  
**303300302**  
**303300314**



↓ 160 cm, Ø 35 cm  
 excl. 1 x E27, max. 60 W



**401100101**  
**401100102**  
**401100114**



**01** weiß · white  
**02** schwarz · black  
**14** braun · brown

01



02



## HOTEL

Nickel matt, Stoff · nickel mat, fabric ·  
 nickel mat, tissu · nikkell mat, textiel · níquel mate, tela ·  
 nichel opaco, tessuto · nichel mat, textil · harjattu teräs, tekstiili ·  
 nikiel mat, tkanina · mat nikel, kumaş



216



Ø 30 cm, ↓ 16 cm  
 excl. 2 x E14, max. 40 W

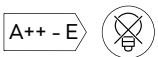

603900201  
 603900202  
 603900214



Ø 50 cm, ↓ 20,5 cm  
 excl. 3 x E27, max. 60 W

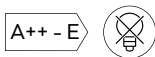

603900301  
 603900302  
 603900314



Ø 65 cm, ↓ 17 cm  
 excl. 5 x E27, max. 60 W

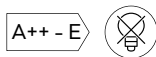

603900501  
 603900502  
 603900514



↓ 32 cm, Ø 20 cm  
 excl. 1 x E14, max. 40 W



501100101  
 501100102  
 501100114



↓ 55 cm, Ø 30 cm  
 excl. 1 x E27, max. 60 W



511100101  
 511100102  
 511100114



↑ 150 - 215 cm, Ø 30 cm, ↗ 107 cm  
excl. 1 x E27, max. 60 W



461100101  
461100102  
461100114

01 weiß · white  
02 schwarz · black  
14 braun · brown

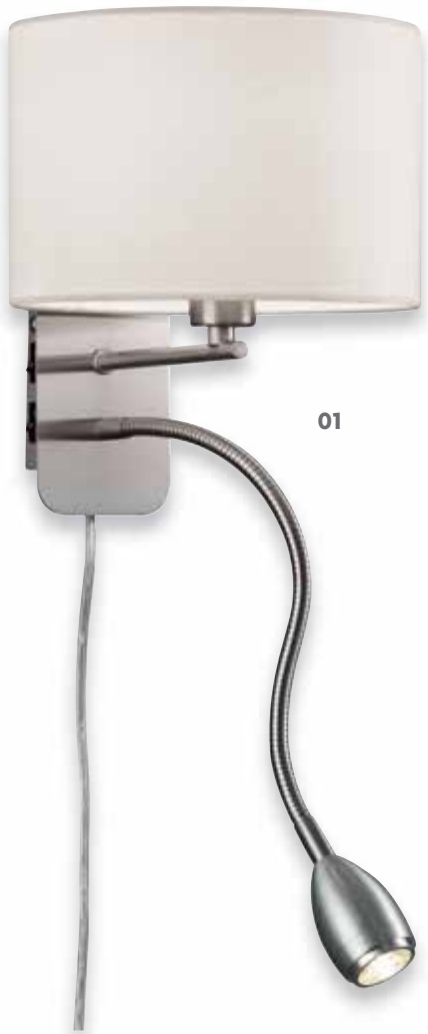

01



14

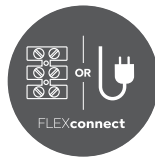

Seite/page 629



01

## HOTEL

Nickel matt, Stoff · matt nickel, fabric  
 Nichel mat, Textil · Mat nikel, Kumaş · Nikiel mat, material ·  
 Harjattu teräs, Tekstiili · Níquel mate, Tela · Nichel opaco, Tessuto ·  
 Nickel mat, Tissu · Nikkel mat, Textiel

218



↔ 20 x 27 cm, ∠ max. 40 cm  
 incl. 1 x SMD-LED, 4 W  
 470 lm, 3.000 K  
 excl. 1 x E14, max. 40 W



271370201  
 271370211  
 271370214



↓ 23,5 cm, Ø 20 cm, ∠ max. 34,5 cm  
 excl. 1 x E14, max. 40 W  
 incl. 1 x COB-LED, 3,2 W  
 300 lm, 3.000 K

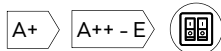

271170201  
 271170202  
 271170214



**01** weiß · white  
**02** schwarz · black  
**11** grau · grey  
**14** braun · brown



11



# ANDREUS

Metall, weiß matt oder schwarz matt · metal, white mat or black mat ·  
metale, blanc mat ou noir mat · metaal, wit mat of mat zwart ·  
metal, estera blanca o estera negra · metallo, bianco opaco o nero opaco ·  
metal, alb mat sau negru mat · metalli, valkoinen matto tai musta matto ·  
metal, biały mat lub czarny mat · metal, beyaz mat veya siyah mat

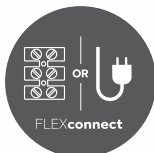

Seite/page 629



Ø 15 cm, ↑ 26,5 cm, ↗ 19,5 cm  
excl. 1 x E14, max. 40 W

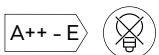

207500179  
207500189



Ø 35 cm, ↑ 150 cm  
excl. 1 x E27, max. 40 W

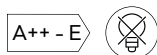

307500179  
307500189



↔ max. 235 cm, ↑ max. 150 cm  
excl. 2 x E14, max. 40 W

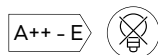

307500279  
307500289



↓ 50 cm, Ø 16 cm, ↗ 32 cm  
excl. 1 x E14, max. 40 W



507500179  
507500189



↑ 180 cm, Ø 35 cm, ↗ 80 cm  
excl. 1 x E27, max. 40 W



407500179  
407500189



79 goldfarbig · gold  
89 silberfarbig · silver

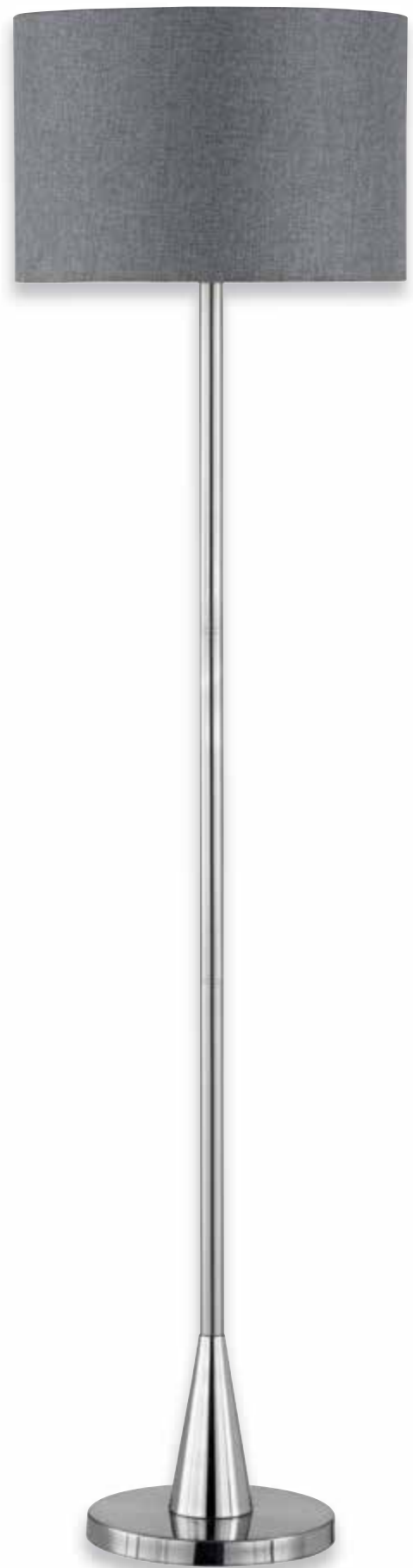

Ø 40 cm, ↓ 150 cm  
excl. 1 x E27, max. 60 W

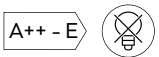

306500107



↓ 35 cm, Ø 20 cm  
excl. 1 x E14, max. 40 W



506500107



↓ 55 cm, Ø 30 cm  
excl. 1 x E27, max. 60 W



556500107



↓ 155 cm, Ø 40 cm  
excl. 1 x E27, max. 60 W



406500107



# COSINUS

Nickel matt, Stoff · nickel mat, fabric ·  
nickel mat, tissu · nikkell mat, textiel ·  
níquel mate, tela · nichel opaco, tessuto ·  
nichel mat, textil · harjattu teräs, tekstiili ·  
nikiel mat, tkanina · mat nikel, kumaş





## GARDA

Nickel matt, Stoffschirm taupe · nickel mat, fabric shade taupe ·  
 nickel mat, abat-jour tissu taupe · nikkell mat, Stoffen kap taupe ·  
 níquel mate, Pantalla de tela gris pardo · nichel opaco, paralume in tessuto taupe ·  
 nichel mat, abajur textil taupe · harjattu teräs, kangas varjostin ruskeanharmaa ·  
 nikiel mat, Klosz z materiału ciemnoszary · mat nikel, Kumaş şapka taupe



On/off touch

224



↓ 18 cm, Ø 9,5 cm  
 excl. 1 x E14, max. 40 W



595400141



↔ 75 x 44,2 cm, ↓ 22 cm  
 excl. 5 x E14, max. 40 W



605400541



↔ 77 x 13,5 cm, ↓ 95 - 150 cm  
 excl. 4 x E14, max. 40 W



305400441





79



89



↓ 18 cm, Ø 9,5 cm  
excl. 1 x E14, max. 40 W



595400101  
595400111  
595400179  
595400189



↔ 75 x 44,2 cm, ↓ 22 cm  
excl. 5 x E14, max. 40 W



605400501  
605400511  
605400579  
605400589



↔ 77 x 13,5 cm, ↓ 95 - 150 cm  
excl. 4 x E14, max. 40 W



305400401  
305400411  
305400479  
305400489



01 weiß · white  
11 grau · grey  
79 goldfarbig · gold  
89 silberfarbig · silver



## GARDA

Nickel matt, Stoffschirm · nickel mat, fabric shade ·  
nickel mat, abat-jour tissu · nikkell mat, Stoffen kap ·  
níquel mate, Pantalla de tela · nichel opaco, paralume in tessuto ·  
nichel mat, abajur textil · harjattu teräs, kangas varjostin ·  
nikiel mat, Klosz z materiału · mat nikel, Kumaş şapka



01



11



On/off touch



# HOSTEL

Metall, weiß matt oder schwarz matt, Stoffschirm · metal, white mat or black mat, fabric shade ·  
 metale, blanc mat ou noir mat, abat-jour tissu · metaal, wit mat of mat zwart, Stoffen kap ·  
 metal, estera blanca o estera negra, Pantalla de tela · metallo, bianco opaco o nero opaco, paralume  
 in tessuto · metal, alb mat sau negru mat, abajur textil · metalli, valkoinen matto tai musta matto,  
 kangas varjostin · metal, biały mat lub czarny mat, Klosz z materiału · metal, beyaz mat veya siyah mat,  
 Kumaş şapka



Ø 30 cm, ↓ 22 cm  
 excl. 2 x E14, max. 40 W

Ø 40 cm, ↓ 150 cm  
 excl. 1 x E27, max. 60 W

↓ 33 cm, Ø 20 cm  
 excl. 1 x E27, max. 60 W

↓ 160 cm, Ø 35 cm  
 excl. 1 x E27, max. 60 W

↓ max. 160 cm, Ø 35 cm, ↗ max. 63 cm  
 excl. 1 x E27, max. 60 W

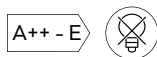
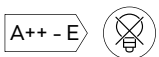

608200279  
 608200289

308200179  
 308200189

508200179  
 508200189

408200179  
 408200189

408290179  
 408290189



79 goldfarbig · gold  
89 silberfarbig · silver



## HOOD

Holz, Stoffschirm · wood, fabric shade ·  
 bois, abat-jour tissu · hout, Stoffen kap ·  
 madera, Pantalla de tela · di legno, paralume in tessuto ·  
 lemn, abajur textil · puu, kangas varjostin ·  
 drewno, Klosz z materiału · tahta, Kumaş şapka



11

01



Ø 36 cm, ↓ 150 cm  
 excl. 1 x E27, max. 40 W

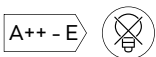

305000101  
 305000111



↓ 50 cm, Ø 24 cm  
 excl. 1 x E27, max. 40 W



505000101  
 505000111



↓ 150 cm, Ø 36 cm  
 excl. 1 x E27, max. 60 W



405000101  
 405000111



01 weiß · white  
 11 grau · grey



# TRIPOLIS

Nickel matt, Stoffschirm · nickel mat, fabric shade ·  
nickel mat, abat-jour tissu · nikkel mat, Stoffen kap ·  
níquel mate, Pantalla de tela · nichel opaco, paralume in tessuto ·  
nichel mat, abajur textil · harjattu teräs, kangas varjostin ·  
nikiel mat, Klosz z materiału · mat nikel, Kumaş şapka

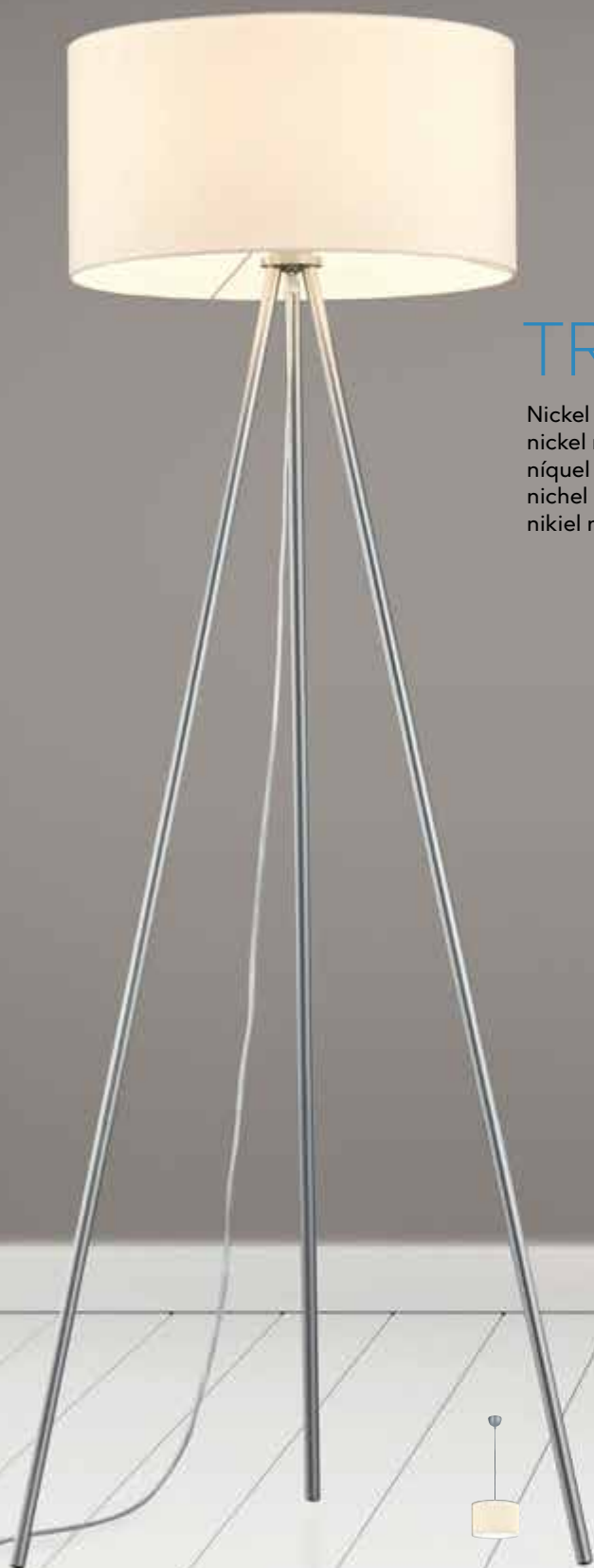

↓ 150 cm, Ø 35 cm  
excl. 1 x E27, max. 60 W

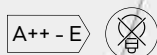

306600101



↓ 50 cm, ↔ 29 cm  
excl. 1 x E14, max. 40 W



506600101



↓ 150 cm, ↔ 66 cm  
excl. 1 x E27, max. 60 W



406600101

VINTAGE





## Leuchten im Vintage Stil

Vintage style luminaires

Luminaire style Vintage

Armaturen in Vintage stijl

Lámparas vintage

Apparecchi stile vintage

Corpuri de iluminat vintage

Vintage valaisimet

Lampy w stylu vintage

# GOTHAM

Metall, silber antik · metal, antique silver ·  
 metale, argent antique · metaal, antiek zilver · metal, plateado antiquo ·  
 metallo, argento anticato · metal, argint antic · metalli, antiikkihopea ·  
 metal, antyczne srebro · metal, gümüş antika

Empfohlen:  
 recommended: Filament LED E27, 6 W  
 420 lm, 2.700 K



A+

987-679

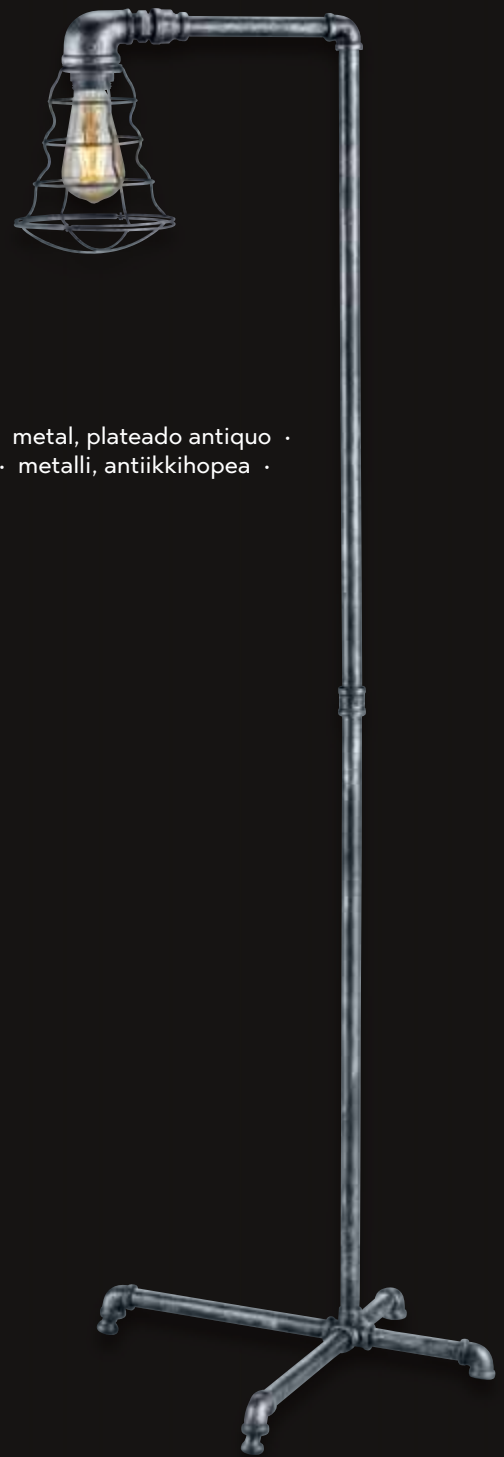

↑ 46,5 x 14,6 cm, ↗ 17,3 cm  
 excl. 1 x E27, max. 60 W



207000188



↑ 150 cm, Ø 14,6 cm  
 excl. 1 x E27, max. 60 W



307000188



↔ 103 x 46,3 cm, ↑ 150 cm  
 excl. 6 x E27, max. 60 W



307000688



↑ 145,5 cm, ↗ 49,5 cm  
 excl. 1 x E27, max. 60 W



407000188



↑ 40 cm, ↗ 40 cm  
 excl. 1 x E27, max. 60 W



507000188





## NO. 5

Metall, silber antik · metal, antique silver ·  
 metale, argent antique · metaal, antiek zilver ·  
 metal, plateado antiguo · metallo, argento anticato ·  
 metal, argint antic · metalli, antiikkihopea ·  
 metal, antyczne srebro · metal, gümüş antika

236



↓ 36 cm, ↔ 20 cm  
 excl. 1 x E27, max. 40 W



504200188



↓ 134 cm, ↔ 60 cm  
 excl. 1 x E27, max. 40 W



404200188





## CORD

Metall, Stoffkabel · metal, fabric sheathed cable ·  
 metale, câble gainé de tissu · metaal, kabel met stofmantel ·  
 metal, cable forrado de tela · metallo, cavo rivestito in tessuto ·  
 metal, țesătură din fibră de sticlă · metalli, kangaspäällysteinen kaapeli ·  
 metal, kabel z osłoną z tkaniny · metal, kumaş kılıflı kablo

Leuchtmittel · Light sources · Ampoules · Lichtbronnen · Fuentes de luz ·  
 Lampadine · Becuri · Valonlähteet · Źródła światła · Işık kaynakları

Seite/page 609



↓ 150 cm, Ø 12 cm  
 excl. 1 x E27, max. 60 W



310100107  
 310100108  
 310100161  
 310100162



↓ 150 cm, ↔ max. 180 cm  
 excl. 5 x E27, max. 60 W



310100561  
 310100562



07 Nickel matt · nickel mat  
 08 Messing matt · brass mat  
 61 grau antik · antique grey  
 62 kupfer antik · antique copper







## TIMBER

Nickel matt, Holz · nickel mat, wood · nickel mat, bois ·  
 nikkell mat, hout · níquel mate, madera · nichel opaco, di legno ·  
 nichel mat, lemn · harjattu teräs, puu · nikiel mat, drewno · mat nikel, tahta



↔ 12,5 x 15 cm, ↗ 21,5 cm  
 excl. 1 x E14, max. 40 W

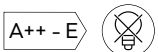

805000130



↔ 35 x 12,5 cm, ↓ 25 cm  
 excl. 2 x E14, max. 40 W

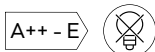

805000230



↔ 65 x 12,5 cm, ↓ 25 cm  
 excl. 3 x E14, max. 40 W

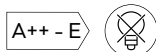

805000330



↔ 90 x 12,5 cm, ↓ 25 cm  
 excl. 4 x E14, max. 40 W



805000430



↓ 45 x 13 cm, ↗ 29 cm  
 excl. 1 x E14, max. 40 W



505000130



↑ 150 x 18 cm, ↗ 44 cm  
excl. 1 x E14, max. 640 W



405000130

↔ 85 x 12,5 cm, ↑ 150 cm  
excl. 4 x E14, max. 40 W



305000430

VINTAGE



## JANKO

Holz, Stoffschirm · wood, fabric shade ·  
bois, abat-jour tissu · hout, Stoffen kap · mader, Pantalla de tela ·  
di legno, paralume in tessuto · lemn, abajur textil · puu, kangas varjostin ·  
drewno, Klosz z materiału · tahta, Kumaş şapka



↓ 44 cm, ↗ 26 cm  
excl. 1 x E14, max. 40 W



507700114



↓ 160 cm, ↗ 40 cm  
excl. 1 x E14, max. 40 W



407700114





VINTAGE



## ROTIN

Rattangeflecht, grau antik · rattan meshwork, antique grey ·  
 maillage rotin, gris ancien · rotan vlechtwerk, antiek grijs · malla de rattan, gris antiguo ·  
 reticolo rattan, grigio antico · impletitura ratan, antic gri · rottinki, antiikki harmaa ·  
 rattan, starodawny szary · örgü, antika gri



↓ 40 cm, Ø 18 cm  
 excl. 1 x E14, max. 40 W



510900111



↓ 165 cm, Ø 39 cm  
 excl. 1 x E27, max. 60 W



410900111



Ø 39 cm, ↓ 150 cm  
 excl. 1 x E27, max. 60 W

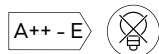

310900111



Ø 70 cm, ↓ 150 cm  
 excl. 5 x E14, max. 40 W

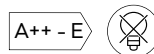

110900511



VINTAGE

62



61



04



## FISHERMAN

Metall, Glas klar · metal, clear glass ·  
metale, verre claire · metaal, helder glas · metal, vidrio claro ·  
metallo, vetro chiaro · metal, sticlă transparentă · metalli, kirkas lasi ·  
metal, przezroczyste szkło · metal, şeffaf



Ø 32 cm, ↑ 150 cm  
excl. 1 x E27, max. 28 W

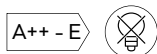

304500104  
304500161  
304500162



**04** altmessing · old brass  
**61** grau antik · gray antique  
**62** kupferfarbig antik · copper-coloured antik



# ELSA

Metall, Glas klar · metal, clear glass ·  
metale, verre claire · metaal, helder glas ·  
metal, vidrio claro · metallo, vetro chiaro ·  
metal, sticlă transparentă · metalli, kirkas lasi ·  
metal, przezroczyste szkło · metal, şeffaf

Empfohlen:  
recommended: Filament LED E27, 6 W  
420 lm, 2.700 K



A+

987-679

61

62



↔ 18,5 x 18,5 cm, ↓ 150 cm  
excl. 1 x E27, max. 60 W

A++ - E



302600161  
302600162

61 grau antik · gray antique  
62 kupferfarbig antik · copper-coloured antique



## BIRTE

Metall, Glas klar · metal, clear glass ·  
 metale, verre claire · metaal, helder glas ·  
 metal, vidrio claro · metallo, vetro chiaro ·  
 metal, sticlă transparentă · metalli, kirkas lasi ·  
 metal, przezroczyste szkło · metal, şeffaf

Empfohlen:  
 recommended: Filamnet LED E14, 4 W  
 400 lm, 3.000 K



A++

989-400



02

61

62



Ø 14,5 cm, ↑ 150 cm  
 excl. 1 x E14, max. 40 W

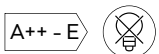

303800102  
 303800161  
 303800162



Ø 12,5 cm, ↑ 22 cm  
 excl. 1 x E14, max. 40 W



503800102  
 503800161  
 503800162



02 schwarz · black  
 61 grau antik · gray antique  
 62 kupferfarbig antik · copper-coloured antique



Ø 30 cm, ↑ 120 cm  
excl. 5 x E14, max. 40 W

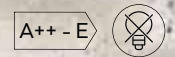

303800517



## ASTRID

Metall, Glas klar · metal, clear glass ·  
 metale, verre claire · metaal, helder glas ·  
 metal, vidrio claro · metallo, vetro chiaro ·  
 metal, sticlă transparentă · metalli, kirkas lasi ·  
 metal, przezroczyste szkło · metal, şeffaf

Empfohlen:  
 recommended: Filament LED E14, 4 W  
 400 lm, 3.000 K



A++

989-400



Ø 14,5 cm, ↑ 150 cm  
 excl. 1 x E14, max. 40 W



302700102



Ø 15 cm, ↑ 28 cm  
 excl. 1 x E14, max. 40 W



502700102



27



62

## EDDA

Metall, Glas · metal, glass ·  
 metale, verre · metaal, glas · metal, vidrio ·  
 metallo, vetro · metal, sticla · metalli, lasi ·  
 metal, szkło · metal, cam

Empfohlen:  
 recommended: Filament LED E27, 6 W  
 600 lm, 3.000 K



A+

987-600



Ø 26,5 cm, ↑ 150 cm  
 excl. 1 x E27, max. 60 W



340100127  
 340100162



27 weiß antik · antique white  
 62 kupferfarbig antik · antique copper



04



61



62

## LINDA

Metall, Glas klar · metal, clear glass ·  
 metale, verre claire · metaal, helder glas ·  
 metal, vidrio claro · metallo, vetro chiaro ·  
 metal, sticlă transparentă · metalli, kirkas lasi ·  
 metal, przezroczyste szkło · metal, şəffaf

Empfohlen:  
 recommended: Filament LED E14, 4 W  
 400 lm, 3.000 K



A++

990-400



Ø 18 cm, ↑ 32,5 cm  
 excl. 1 x E14, max. 40 W



503500104  
 503500161  
 503500162

04 altmessing · old brass  
 61 grau antik · gray antique  
 62 kupferfarbig antik · copper-coloured antik

# JUDTIH

Glas klar · clear glass ·  
verre claire · helder glas ·  
vidrio claro · vetro chiaro ·  
sticlă transparentă · kirkas lasi ·  
przezroczyste szkło · şeffaf

Empfohlen:

recommended: Filament LED E27, 6 W  
420 lm, 2.700 K



A+

987-679



253



Ø 24,5 cm, ↑ 150 cm  
excl. 1 x E27, max. 60 W

A++ - E



302900102



32



61



62

## LARA

Metall, Glas matt · metal, mat glass ·  
 metallo, vetro sabbato · metal, sticla mata · metalli, matalasi ·  
 metal, szklo matowane · metal, mat cam



↔ 28 x 15 cm, ↑ 21 cm  
 excl. 1 x E14, max. 28 W



508400132  
 508400161  
 508400162



32 schwarz matt · black mat  
 61 grau antik · antique grey  
 62 kupfer antik · antique copper



# TANJA

Metall · metal ·  
metale · metaal · metal · metallo ·  
metal · metalli · metal · metal



# SANNA

Metall · metal ·  
metale · metaal · metal · metallo ·  
metal · metalli · metal · metal



255

Ø 25 cm, ↑ 150 cm  
excl. 1 x E27, max. 60 W



300900101  
300900102

Ø 39 cm, ↑ 150 cm  
excl. 1 x E27, max. 60 W



300700101  
300700102



01 weiß · white  
02 schwarz · black



61

## JOHANN

Metall, grau antik oder kupfer antik · metal, antique grey or antique copper ·  
 metale, gris ancien ou cuivre ancien · metaal, antiek grijs of antiek koper ·  
 metal, gris antiguo o cobre antiguo · metallo, grigio antico o rame antico ·  
 metal, antic gri sau cupru antic · metalli, antiikki harmaa tai antiikki kupari ·  
 metal, starodawny szary lub antyczne miedzi · metal, antika gri veya antik bakır

Empfohlen:

recommended: Filament-LED E27, 6 W  
 600 lm, 3.000 K



987-660

62

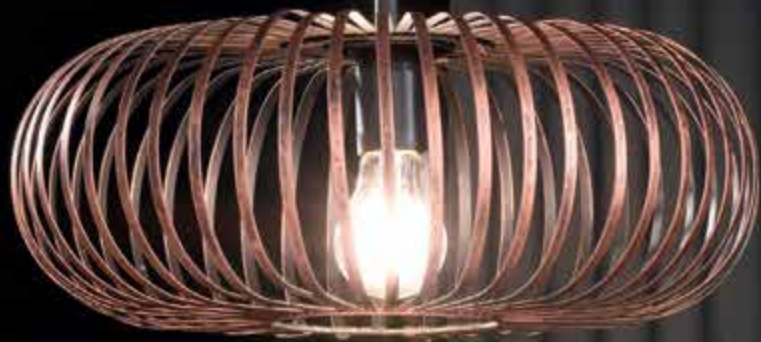

Ø 40 cm, ↑ 17 cm  
 excl. 1 x E27, max. 60 W

↑ 150 cm, Ø 40 cm  
 excl. 1 x E27, max. 60 W

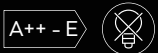

606900161  
 606900162

306900161  
 306900162

61 grau antik · antique grey  
 62 kupfer antik · antique copper



# JACOB

Metall, grau antik oder kupfer antik · metal, antique grey or antique copper ·  
 metale, gris ancien ou cuivre ancien · metaal, antiek grijs of antiek koper ·  
 metal, gris antiguo o cobre antiguo · metallo, grigio antico o rame antico ·  
 metal, antic gri sau cupru antic · metalli, antiikki harmaa tai antiikki kupari ·  
 metal, starodawny szary lub antyczne miedzi · metal, antika gri veya antik bakır

Empfohlen:

recommended: Filament LED E27, 6 W  
 600 lm, 3.000 K



A+

988-660



62



61



Ø 30 cm, ↑ 31 cm  
 excl. 1 x E27, max. 60 W



505100161  
 505100162



Ø 40 cm, ↑ 150 cm  
 excl. 1 x E27, max. 60 W



305100161  
 305100162



61 grau antik · antique grey  
 62 kupfer antik · antique copper



04



62

## FRIEDA

Metall · metal ·  
metale · metaal · metal · metallo ·  
metal · metalli · metal · metal

258



Ø 33 cm, ↓ 150 cm  
excl. 1 x E27, max. 40 W

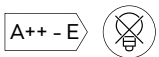

302200104  
302200161  
302200162



↔ 28 x 16 cm, ↗ 15 cm  
excl. 1 x E14, max. 40 W

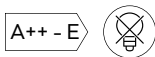

202200104  
202200161  
202200162



**04** altmessing · old brass  
**61** grau antik · gray antique  
**62** kupferfarbig antik · copper-coloured antik



61



# JANA

Metall · metal ·  
metale · metaal · metal · metallo ·  
metal · metalli · metal · metal



04

62

61



↔ 10,5 x 10,5 cm, ↓ 27,5 cm  
excl. 1 x E14, max. 40 W



503300104  
503300161  
503300162

04 altmessing · old brass  
61 grau antik · gray antique  
62 kupferfarbig antik · copper-coloured antik

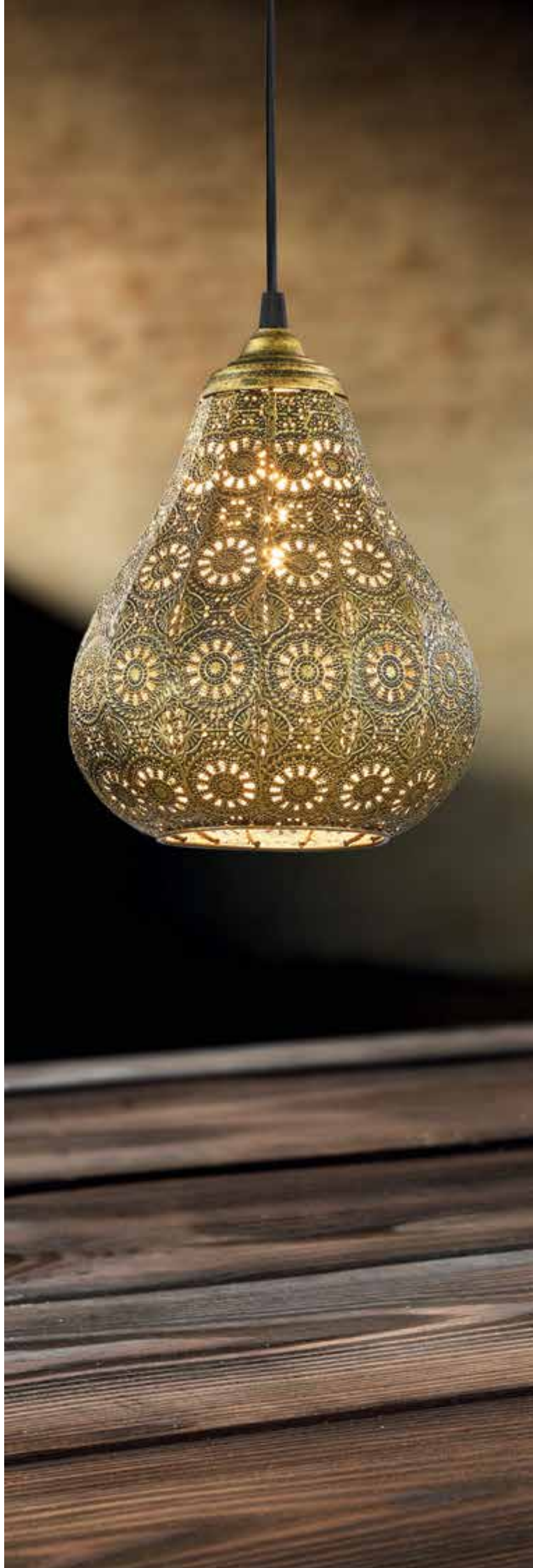

# JASMIN

Metall · metal ·  
metale · metaal · metal · metallo ·  
metal · metalli · metal · metal



62



61



04



Ø 19 cm, ↑ 150 cm  
excl. 1 x E14, max. 40 W

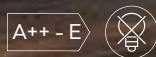

303700104  
303700161  
303700162



Ø 19 cm, ↑ 36 cm  
excl. 1 x E14, max. 40 W

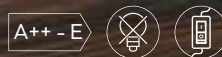

503700104  
503700161  
503700162



**04** altmessing · old brass  
**61** grau antik · gray antique  
**62** kupferfarbig antik · copper-coloured antique







## Wand- und Deckenleuchten

Wall & Ceiling lamps  
Plafonniers & appliques  
Wandlampen & plafonnières  
Apliques y plafones  
Applique e plafoniere  
Plafoniere si aplice  
Seinä- & katto  
Sufitowe i ścienne  
Tavan & Duvar armatürleri



# TORRANCE

Metall, titanfarbig, Acryl · metal, titan, acryl ·  
 metale, titane, acryl · metaal, titaan, acryl · metal, titán, acrílico ·  
 metallo, titano, acrilico · metal, titaniu, acrilic · metalli, titaani, akryyli ·  
 metal, tytanowy, akryl · metal, titan, akrilik



↔ 64 x 44 cm, ↑ 6,2 cm  
 incl. SMD-LED, 32 W  
 3.200 lm, 2.700 - 6.500 K



674110687

↔ 80 x 52 cm, ↑ 6,2 cm  
 incl. SMD-LED, 45 W  
 5.000 lm, 2.700 - 6.500 K



674110887

↔ 110 x 70 cm, ↑ 6,2 cm  
 incl. SMD-LED, 55 W  
 6.000 lm, 2.700 - 6.500 K



674111187



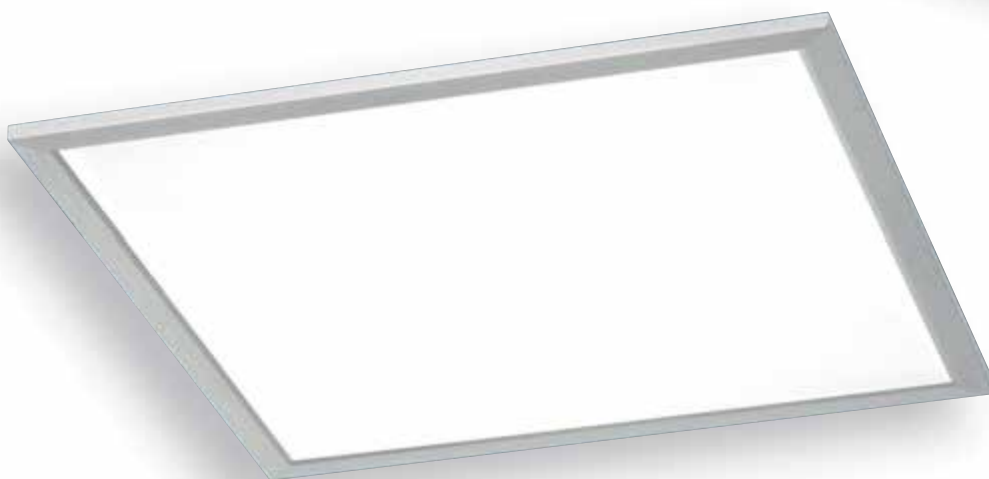

## PHOENIX

Nickel matt, Acryl · nickel mat, acryl ·  
nickel mat, acryl · nikkell mat, acryl · níquel mate, acrílico · nichel opaco, acrílico ·  
nichel mat, acrilicharjattu teräs, akryyli · nikiel mat, akryl · mat nikel, akrilik



Ø 30 cm, ↓ 4,5 cm  
incl. SMD-LED, 15 W  
1.500 lm, 3.000 K



674093007



Ø 45 cm, ↓ 4,5 cm  
incl. SMD-LED, 24 W  
2.500 lm, 3.000 K



674094507



Ø 62 cm, ↓ 4,5 cm  
incl. SMD-LED, 30 W  
3.000 lm, 3.000 K



674096207



↔ 30 x 30 cm, ↓ 4 cm  
incl. SMD-LED, 15 W  
1.500 lm, 3.000 K



674013007



↔ 45 x 45 cm, ↓ 4 cm  
incl. SMD-LED, 24 W  
2.500 lm, 3.000 K

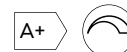

674014507



↔ 62 x 62 cm, ↓ 4 cm  
incl. SMD-LED, 30 W  
3.000 lm, 3.000 K



674016207

↔ 120 x 30 cm, ↓ 4 cm  
incl. SMD-LED, 30 W  
3.000 lm, 3.000 K



674011207



## LUCAS

Aluminium gebürstet, Acryl · brushed aluminium, acryl · aluminium balayé, acryl · geborsteld aluminium, acryl · aluminio pulido, acrílico · alluminio spazzolato, acrilico · aluminiu lucios, acrilic · harjattu alumiini, akryyli · aluminium szczotkowane, akryl · alüminyum, akrilik



## MARCOS

Aluminium gebürstet, Acryl · brushed aluminium, acryl · aluminium balayé, acryl · geborsteld aluminium, acryl · aluminio pulido, acrílico · alluminio spazzolato, acrilico · aluminiu lucios, acrilic · harjattu alumiini, akryyli · aluminium szczotkowane, akryl · alüminyum, akrilik



↔ 41,5 x 41,5 cm, ↓ 4,5 cm  
incl. SMD-LED, 24 W  
2.000 lm, 3.000 K

↔ 81,5 x 31,5 cm, ↓ 5 cm  
incl. SMD-LED, 30 W  
3.000 lm, 3.000 K

↔ 28 x 28 cm, ↓ 9 cm  
incl. SMD-LED, 12 W  
1.050 lm, 3.000 K

↔ 43 x 43 cm, ↓ 10 cm  
incl. SMD-LED, 23 W  
2.000 lm, 3.000 K



659512405



659513605

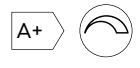

625911205



625912305

# FUTURE

Edelstahl, Acryl · steel, acryl ·  
acier, acryl · staal, acryl · acero, acrílico ·  
acciaio, acrilico · inox, acrilic · teräs, akryyli ·  
stal, akryl · çelik, akrilik

IP44

269

↔ 40 x 40 cm, ↑ 4,5 cm  
incl. SMD-LED, 18 W  
1.600 lm, 3.500 K

A+ IP44

622714007

↔ 30 x 30 cm, ↑ 4,5 cm  
incl. SMD-LED, 12 W  
1.100 lm, 3.500 K

A+ IP44

622713007



## HOKKAIDO

Nickel matt, Acryl · nickel mat, acryl ·  
nickel mat, acryl · nikkell mat, acryl · níquel mate, acrílico ·  
nichel opaco, acrilico · nichel mat, acrilic · harjattu teräs, akryyli ·  
nikiel mat, akryl · mat nikel, akrilik



270



↔ 80 x 30 cm, ↑ 7,7 cm  
incl. SMD-LED, max. 40 W  
max. 3.800 lm, 3.000 - 5.500 K



658090107

↔ 50 x 50 cm, ↑ 7,7 cm  
incl. SMD-LED, max. 40 W  
max. 3.800 lm, 3.000 - 5.500 K



658010107



# KOBE

Nickel matt, Acryl · nickel mat, acryl ·  
nickel mat, acryl · nikkel mat, acryl · níquel mate, acrílico ·  
nichel opaco, acrílico · nichel mat, acrilic · harjattu teräs, akryyli ·  
nikiel mat, akryl · mat nikel, akrilik



Ø 50 cm, ↓ 7,7 cm  
incl. SMD-LED, max. 40 W  
max. 3.800 lm, 3.000 - 5.500 K



658110107

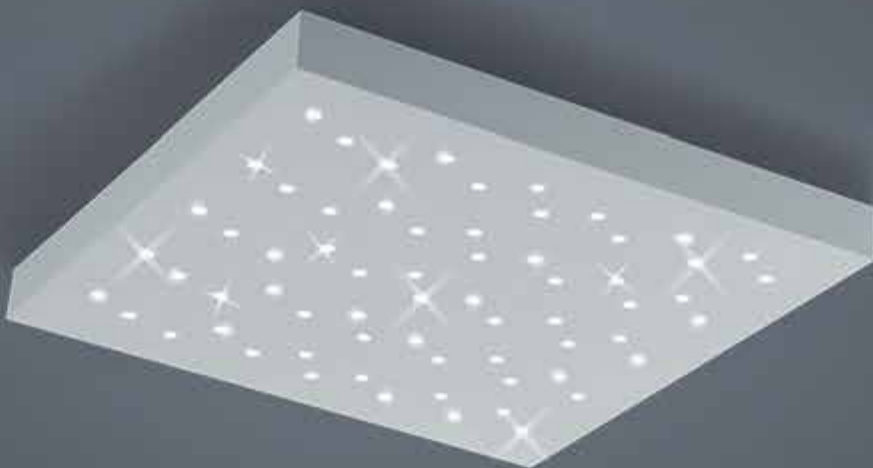
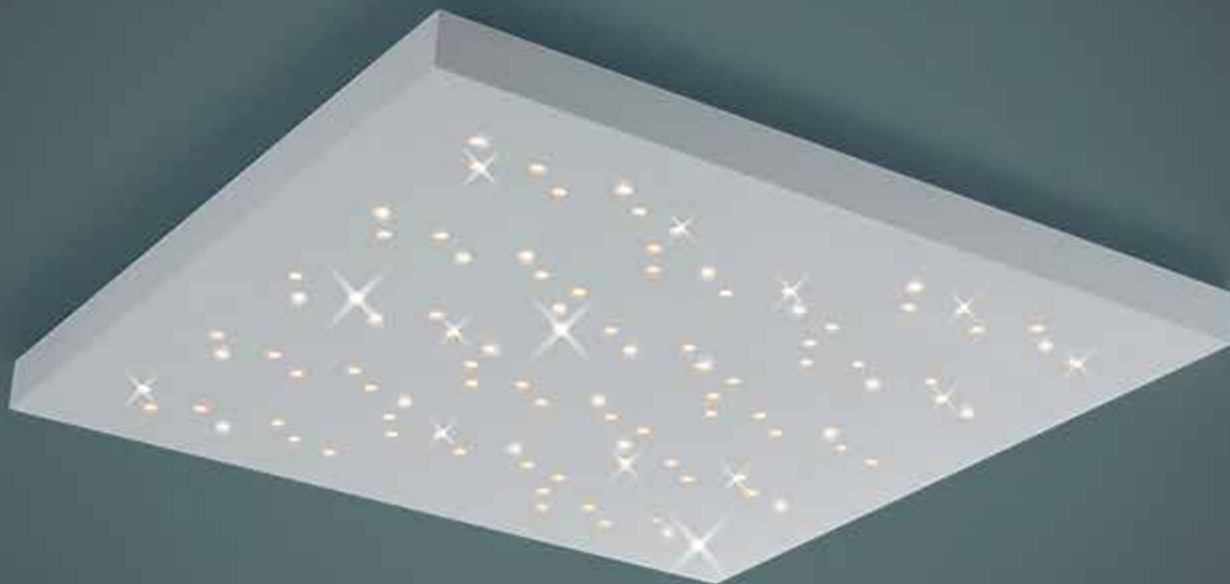

## TITUS

Metall, weiß matt · metal, white mat ·  
 metale, blanc mat · metaal, wit mat · metal, estera blanca · metallo, bianco opaco ·  
 metal, alb mat · metalli, valkoinen matto · metal, biały mat · metal, beyaz mat

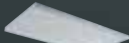

↔ 50 x 50 cm, ↑ 4,5 cm  
 incl. SMD-LED, 22 W  
 2.100 lm, 3.000 - 6.000 K



676615031

↔ 75 x 75 cm, ↑ 4,5 cm  
 incl. SMD-LED, 36 W  
 3.300 lm, 3.000 - 6.000 K



676617531

↔ 110 x 60 cm, ↑ 4,5 cm  
 incl. SMD-LED, 48 W  
 4.300 lm, 3.000 - 6.000 K



676611031





## SUBARA

Metall weiß matt, Acryl · metal white mat, acryl ·  
metale blanc mat, acryl · metaal wit mat, acryl · metal estera blanca, acrílico ·  
metallo bianco opaco, acrilico · metal alb mat, acrilic ·  
metalli valkoinen matto, akryyli · metal biały mat, akryl · metal beyaz mat, akrilik



### LED SWITCHDIMMER



↔ 40 x 26 cm, ↑ 5,6 cm  
incl. SMD-LED, 20 W  
2.100 lm, 3.000 + 5.000 K



274510107



↔ 88 x 58 cm, ↑ 6,4 cm  
incl. SMD-LED, 58 W  
5.400 lm, 3.000 - 5.500 K



674510107





## SUZUKA

Metall weiß matt, Acryl · metal white mat, acryl ·  
 metale blanc mat, acryl · metaal wit mat, acryl · metal estera blanca, acrílico ·  
 metallo bianco opaco, acrilico · metal alb mat, acrilic · metalli valkoinen matto, akryyli ·  
 metal biały mat, akryl · metal beyaz mat, akrilik



↔ 55 x 55 cm, ↑ 6,5 cm  
 incl. 1 x SMD-LED, max. 45 W  
 max. 3.800 lm, 3.000 - 5.500 K



675010101



↔ 70 x 70 cm, ↑ 6,5 cm  
 incl. 1 x SMD-LED, max. 60 W  
 max. 5.300 lm, 3.000 - 5.000 K



675070101



↔ 98 x 68 cm, ↑ 6,5 cm  
 incl. 1 x SMD-LED, max. 75 W  
 max. 7.000 lm, 3.000 - 5.500 K



675090101

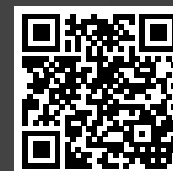





# LOTUS

Acryl, weiß, chrom · acryl, white, chrome ·  
 acryl, blanc, chrome · acryl, wit, chrom · acrílico, blanco, cromo ·  
 acrilico, bianco, cromo · acrilic, alb, crom · akryyli, valkoinen, kromi ·  
 akryl, biały, chrom · akrilik, beyaz, krom



Seite/page 628

278



Ø 60 cm, ↑ 7,5 cm  
 incl. SMD-LED, max. 45 W  
 4.000 lm, 3.000 - 5.500 K



629010101



Ø 80 cm, ↑ 9 cm  
 incl. SMD-LED, max. 70 W  
 6.500 lm, 3.000 - 5.500 K



629090101







## TOYAMA

Acryl mit Kristalleffekt · broken glass optic ·  
 optique verre pilé · Gebroken glas optiek · Efecto cristal roto · effetto ottico vetro rotto ·  
 aspect de sticla sparta · lasi efekti optiikka · Optyczne rozbite szkło · Çatlatma cam



Seite/page 628



## AKURA

Acryl mit Kristalleffekt · broken glass optic ·  
 optique verre pilé · Gebroken glas optiek · Efecto cristal roto ·  
 effetto ottico vetro rotto · aspect de sticla sparta ·  
 lasi efekti optiikka · Optyczne rozbite szkło · Çatlatma cam



Ø 60 cm, ↑ 6,5 cm  
 incl. SMD-LED, max. 45 W  
 4.000 lm, 3.000 - 5.500 K

↔ 52 x 52 cm, ↑ 6,5 cm  
 incl. SMD-LED, max. 45 W  
 4.000 lm, 3.000 - 5.500 K



Seite/page 628



628990100

628890100



# TAKESHI

Acryl, Starlight-Effekt · acryl, starlight effect ·  
acryl, effet étoile · acryl, sterlicht effect · acrílico, efecto de la luz ·  
acrílico, effetto di stelle · acrilic, efect lumina stelelor · akryyli, starlight vaikutus ·  
akryl, efekt starlight · akrilik, starlight etkisi



Seite/page 628



Ø 80 cm, ↑ 9 cm  
incl. SMD-LED, max. 70 W  
6.500 lm, 3.000 - 5.500 K



628918000



LED SWITCHDIMMER



Ø 21 cm, ↑ 5 cm  
incl. SMD-LED, max. 12 W  
max. 1.050 lm, 3.000 K

Ø 42 cm, ↑ 7 cm  
incl. SMD-LED, max. 30 W  
max. 3.100 lm, 3.000 - 6.000 K

Ø 67 cm, ↑ 10 cm  
incl. SMD-LED, max. 100 W  
max. 9.800 lm, 3.000 - 6.000 K



678711206

678713006

678710006



## OSAKA

chrom, Acryl, Starlight-Effekt · chrome, acryl, starlight effect ·  
chrome, acryl, effet étoile · chroom, acryl, sterlicht effect ·  
cromo, acrílico, efecto de la luz · cromo, acrilico, effetto di stelle ·  
chrom, acrilic, efect lumina stelelor · kromi, akryyli, starlight vaikutus ·  
chrom, akryl, efekt starlight · krom, akrilik, starlight etkisi





## NAGANO

Acryl, Starlight-Effekt · acryl, starlight effect ·  
acryl, effet étoile · acryl, sterlicht effect · acrílico, efecto de la luz ·  
acrilico, effetto di stelle · acrilic, efect lumina stelelor · akryyli, starlight vaikutus ·  
akryl, efekt starlight · akrilik, starlight etkisi



Ø 80 cm, ↑ 10,8 cm  
incl. 1 x SMD-LED, max. 80 W  
max. 6.400 lm, 3.000 - 5.500 K



677718000



## MIKO

chrom, Acryl, Starlight-Effekt · chrome, acryl, starlight effect ·  
chrome, acryl, effet étoile · chrom, acryl, sterlicht effect ·  
cromo, acrílico, efecto de la luz · cromo, acrilico, effetto di stelle ·  
chrom, acrilic, efect lumina stelelor · kromi, akryyli, starlight vaikutus ·  
chrom, akryl, efekt starlight · krom, akrilik, starlight etkisi



Ø 85 cm, ↑ 11 cm  
incl. SMD-LED, 95 W  
9.600 lm, 3.000 - 6.000 K



675610106

## TOLEDO

Nickel matt, Acryl, Starlight-Effekt · nickel mat, acryl, starlight effect ·  
nickel mat, acryl, effet étoile · nikkell mat, acryl, sterlicht effect ·  
níquel mate, acrílico, efecto de la luz · nichel opaco, acrílico, effetto di stelle ·  
nichel mat, acrilic, efect lumina stelelor · harjattu teräs, akryyli, starlight vaikutus ·  
nikiel mat, akryl, efekt starlight · mat nikel, akrilik, starlight etkisi



## CHIBA

Acryl, Starlight-Effekt · acryl, starlight effect ·  
acryl, effet étoile · acryl, sterlicht effect · acrílico, efecto de la luz ·  
acrílico, effetto di stelle · acrilic, efect lumina stelelor · akryyli, starlight vaikutus ·  
akryl, efekt starlight · akrilik, starlight etkisi



↔ 110 x 9 cm, ↓ 9 cm  
incl. SMD-LED, 29 W  
2.850 lm, 3.000 - 5.000 K



679310107

↔ 110 x 30 cm, ↓ 7,7 cm  
incl. SMD-LED, max. 60 W  
max. 5.800 lm, 3.000 - 5.500 K



628898000





## KYOTO

Acryl, Starlight-Effekt · acryl, starlight effect ·  
acryl, effet étoile · acryl, sterlicht effect · acrílico, efecto de la luz ·  
acrilico, effetto di stelle · acrilic, efect lumina stelelor · akryyli, starlight vaikutus ·  
akryl, efekt starlight · akrilik, starlight etkisi



Seite/page 628

287



↔ 73 x 73 cm, ↑ 7,2 cm  
incl. SMD-LED, max. 60 W  
max. 5.800 lm, 3.000 - 5.500 K



628818000



## TOKYO

Acryl · acryl · acryl · acryl · acrílico · acrilico · acrilic · akryyli · akryl · akrilik



Seite/page 628



## KYOTO

Acryl · acryl · acryl · acryl · acrílico · acrilico · acrilic · akryyli · akryl · akrilik



Seite/page 628



Ø 60 cm, ↑ 6,5 cm  
incl. SMD-LED, 45 W  
4.000 lm, 3.000 - 5.500 K



628915001

↔ 52,5 x 52,5 cm, ↑ 6,5 cm  
incl. SMD-LED, 50 W  
4.000 lm, 3.000 - 5.500 K



628815001



## SHOGUN

Acryl, Starlight-Effekt · acryl, starlight effect ·  
 acryl, effet étoile · acryl, sterlicht effect ·  
 acrílico, efecto de la luz · acrílico, effetto di stelle ·  
 acrílic, efect lumina stelelor · akryyli, starlight vaikutus ·  
 akryl, efekt starlight · akrilik, starlight etkisi



## SAMURAI

Acryl, Starlight-Effekt · acryl, starlight effect ·  
 acryl, effet étoile · acryl, sterlicht effect ·  
 acrílico, efecto de la luz · acrílico, effetto di stelle ·  
 acrílic, efect lumina stelelor · akryyli, starlight vaikutus ·  
 akryl, efekt starlight · akrilik, starlight etkisi



Ø 42,5 cm, ↑ 6 cm  
 incl. SMD-LED, 30 W  
 2.400 lm, 3.000-5.500 K



628513001

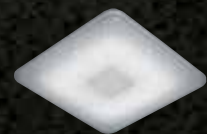

↔ 42,5 x 42,5 cm, ↑ 6 cm  
 incl. SMD-LED, 30 W  
 2.400 lm, 3.000-5.500 K



628613001



## SAPPORO

Acryl, Starlight-Effekt · acryl, starlight effect ·  
acryl, effet étoile · acryl, sterlicht effect ·  
acrílico, efecto de la luz · acrilico, effetto di stelle ·  
acrilic, efect lumina stelelor · akryyli, starlight vaikutus ·  
akryl, efekt starlight · akrilik, starlight etkisi



↔ 41,5 x 41,5 cm, ↑ 7,5 cm  
incl. SMD-LED, max. 30 W  
max. 2.100 lm, 3.000 - 5.500 K



677610106

↔ 51,5 x 51,5 cm, ↑ 8,5 cm  
incl. SMD-LED, max. 60 W  
max. 4.500 lm, 3.000 - 5.500 K



677690106



## CUMANO

Acryl · acryl ·  
acryl · acryl · acrílico · acrilico · acrilic · akryyli · akryl · akrilik



291

Ø 74 cm, ↑ 12,6 cm  
incl. SMD-LED, 60 W  
max. 5.800 lm, 3.000 - 5.500 K



675310106

## SHAOLIN

Acryl · acryl ·  
acryl · acryl · acrílico · acrilico ·  
acrilic · akryyli · akryl · akrilik



## YOKOHAMA

Acryl, Fernbedienung · acryl, remote control ·  
acryl, commande à distance · acryl, afstandsbediening · acrílico, mando a distancia ·  
acrilico, comando a distanza · acrilic, telecomanda · akryyli, kauko-ohjain ·  
akryl, pilot · akrilik, uzaktan kumanda



Ø 45 cm, ↑ 5,5 cm  
incl. SMD-LED, 30 W  
max. 2.500 lm, 3.000 - 5.500 K



628313001



Ø 48 cm, ↑ 10 cm,  
incl. SMD-LED, max. 40 W  
max. 3.600 lm, 3.000 - 5.500 K



658714001

# CONTRAST

Acryl, Starlight-Effekt · acryl, starlight effect ·  
acryl, effet étoile · acryl, sterlicht effect · acrílico, efecto de la luz ·  
acrílico, effetto di stelle · acrilic, efect lumina stelelor ·  
akryyli, starlight vaikutus · akryl, efekt starlight · akrilik, starlight etkisi

**LED SWITCHDIMMER**



# CONDOR

Acryl, Starlight-Effekt · acryl, starlight effect ·  
acryl, effet étoile · acryl, sterlicht effect · acrílico, efecto de la luz ·  
acrílico, effetto di stelle · acrilic, efect lumina stelelor ·  
akryyli, starlight vaikutus · akryl, efekt starlight · akrilik, starlight etkisi

**LED SWITCHDIMMER**



# OREGON

Acryl, Starlight-Effekt · acryl, starlight effect ·  
acryl, effet étoile · acryl, sterlicht effect · acrílico, efecto de la luz ·  
acrílico, effetto di stelle · acrilic, efect lumina stelelor ·  
akryyli, starlight vaikutus · akryl, efekt starlight · akrilik, starlight etkisi

**LED SWITCHDIMMER**



↔ 42,5 x 42,5 cm, ↑ 9 cm  
incl. SMD-LED, 21 W  
2.200 lm, 4.000 K



657910100



∅ 42 cm, ↑ 9,5 cm  
incl. SMD-LED, 21 W  
2.200 lm, 4.000 K



657810100



∅ 43 cm, ↑ 9 cm  
incl. SMD-LED, 21 W  
2.200 lm, 4.000 K



657710100



## CONCORDE

Acryl · acryl ·  
acryl · acryl · acrílico · acrilico ·  
acrilic · akryyli · akryl · akrilik

**LED AUTODIMMER**



## CONGRESS

Acryl · acryl ·  
acryl · acryl · acrílico · acrilico ·  
acrilic · akryyli · akryl · akrilik

**LED AUTODIMMER**



↔ 43 x 43 cm, ↓ 9,4 cm  
incl. SMD-LED, 21 W  
max. 2.000 lm, 3.000 K



658512601



Ø 41 cm, ↓ 9 cm  
incl. SMD-LED, 21 W  
max. 2.000 lm, 3.000 K



658412601

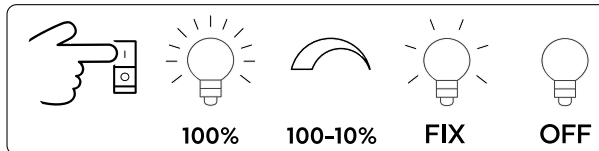

Durch mehrmaliges Schalten lässt sich die Helligkeit stufenlos einstellen ·  
The level of brightness can be adjusted infinitely by switching several times ·  
Varier infiniment le niveau d'éclairage en utilisant l'interrupteur de manière répétée ·  
Door meermaals te schakelen kan de helderheid traploos ingesteld worden ·  
El brillo se puede variar infinitamente encendiendo repetidas veces ·  
Il livello di luminosità, può essere regolato infinite volte ad ogni accensione ·  
Nivelul de lumina poate fi ajustat infinit de mult utilizand intrerupatorul de cateva ori ·  
Kirkkauden tason voi säätää useammalla painalluksella ·  
Przez wielokrotne przełączenie, jasność można regulować bezstopniowo ·  
Parlaklık seviyesi birkaç açma kapama hamlesi ile sınırsızca ayarlanabilir





## CONTENDER

Nickel matt, Acryl · nickel mat, acryl ·  
 nickel mat, acryl · nikkell mat, acryl · níquel mate, acrílico ·  
 nichel opaco, acrílico · nichel mat, acrílico · harjattu teräs, akryyli ·  
 nikiel mat, akryl · mat nikel, akrilik

**LED AUTODIMMER**



## CONVERTER

Acryl · acryl ·  
 acryl · acryl · acrílico · acrílico ·  
 acrílico · akryyli · akryl · akrilik

**LED AUTODIMMER**



Ø 30 cm, ↓ 9,5 cm  
 incl. SMD-LED, 11 W  
 max. 1.000 lm, 3.000 K



**658311401**



Ø 43 cm, ↓ 10 cm  
 incl. SMD-LED, 21 W  
 max. 2.000 lm, 3.000 K



**658312601**



Ø 31 cm, ↓ 9 cm  
 incl. SMD-LED, 11 W  
 max. 1.000 lm, 3.000 K



**658611407**



Ø 42 cm, ↓ 10 cm  
 incl. SMD-LED, 21 W  
 max. 2.000 lm, 3.000 K

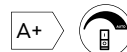

**658612607**



**01** weiß · white  
**07** Nickel matt · nickel mat



# TURNER

chrom, Acryl · chrome, acryl ·  
 chrome, acryl · chroom, acryl · cromo, acrílico ·  
 cromo, acrílico · crom, acrílic · kromi, akryyli ·  
 chrom, akryl · krom, akrilik



296



Ø 45 cm, ↑ 15 cm  
 incl. 3 x SMD-LED, 4,2 W  
 3 x 400 lm, 3.000 K

A+



624410306

Ø 63 cm, ↑ 15 cm  
 incl. 5 x SMD-LED, 4,2 W  
 5 x 400 lm, 3.000 K

A+



624410506

↔ 57 x 37 cm, ↑ 20 cm  
 incl. 6 x SMD-LED, 4,2 W  
 6 x 400 lm, 3.000 K

A+



624410606

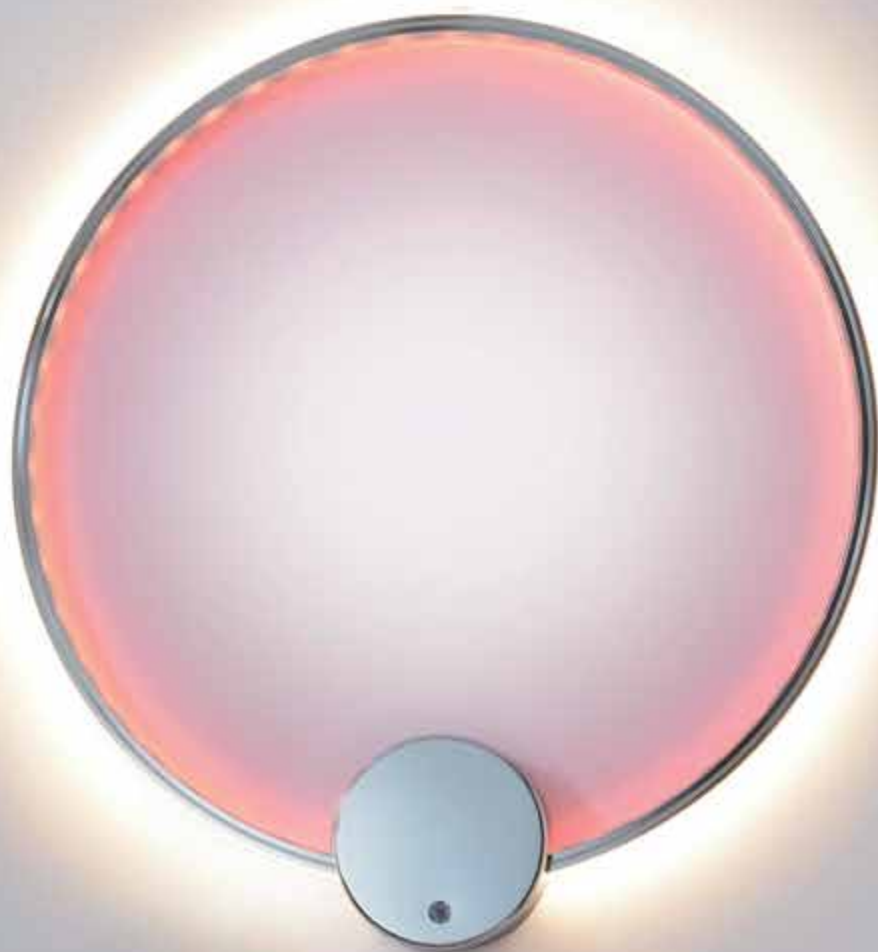

## DRAGON

chrom, Acryl · chrome, acryl ·  
chrome, acryl · chroom, acryl · cromo, acrílico · cromo, acrílico ·  
crom, acrílic · kromi, akryyli · chrom, akryl · krom, akrilik



Ø 69,5 cm, ↓ 4,5 cm  
incl. SMD-LED, 30 W  
2.500 lm, 3.000 K  
incl. RGB-SMD, 15 W  
1.300 lm



620210206



31

## SEDONA

Aluminium gebürstet oder weiß matt · brushed aluminium or white mat · aluminium balayé ou blanc mat · geborsteld aluminium of wit mat · aluminio pulido o estera blanca · alluminio spazzolato o bianco opaco · aluminiiu lucios sau alb mat · harjattu alumiini tai valkoinen matto · aluminium szczotkowane lub biały mat · alüminyum veya beyaz mat

**LED SWITCHDIMMER**

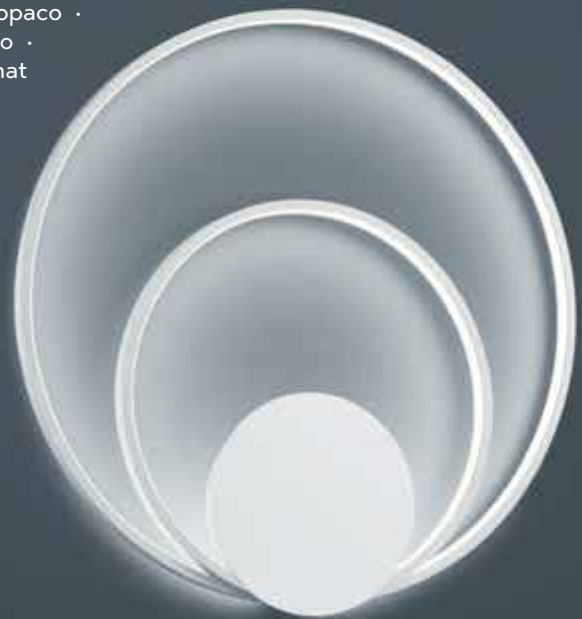

298



Ø 60 cm, ↑ 6 cm  
incl. SMD-LED, 30 W  
2.800 lm, 3.000 K



673210206  
673210231

Ø 80 cm, ↑ 8 cm  
incl. SMD-LED, 40 W  
3.600 lm, 3.000 K



673210306  
673210331



**06** chrom · chrome  
**31** weiß matt · white mat



06



# HYDRA

Nickel matt · nickel mat ·  
 nickel mat · nikkell mat · níquel mate · nichel opaco ·  
 nichel mat · harjattu teräs · nikiel mat · mat nikel

## LED SWITCHDIMMER



Seite/page 629

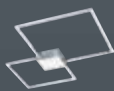

↔ 52,5 x 40,5 cm, ↗ 3,5 cm  
 incl. SMD-LED, 20 W  
 1.450 lm, 3.000 K

↔ 60 cm, ↑ 30 cm, ↗ 4 cm  
 incl. SMD-LED, 15,5 W  
 1.250 lm, 3.000 K

↔ 65 x 65 cm, ↑ 5 cm  
 incl. SMD-LED, 28 W  
 2.600 lm, 3.000 K

↔ 80,5 x 45 cm, ↑ 5 cm  
 incl. SMD-LED, 28 W  
 2.600 lm, 3.000 K



276210207



276290107



676210307



676290307



## HYDRA

Nickel matt · nickel mat ·  
nickel mat · nikkell mat · níquel mate · nichel opaco ·  
nichel mat · harjattu teräs · nikiel mat · mat nikel

**LED SWITCHDIMMER**

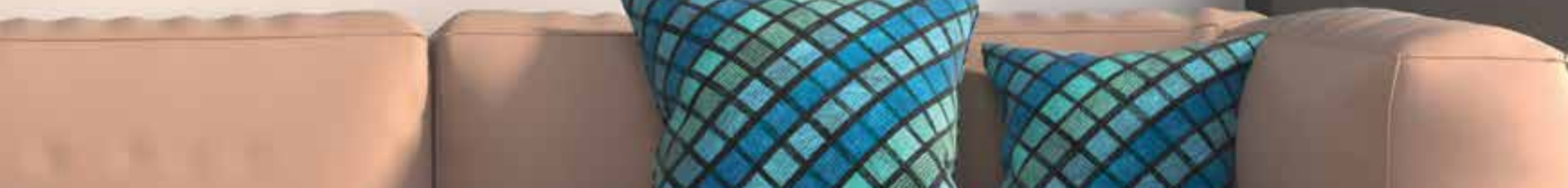

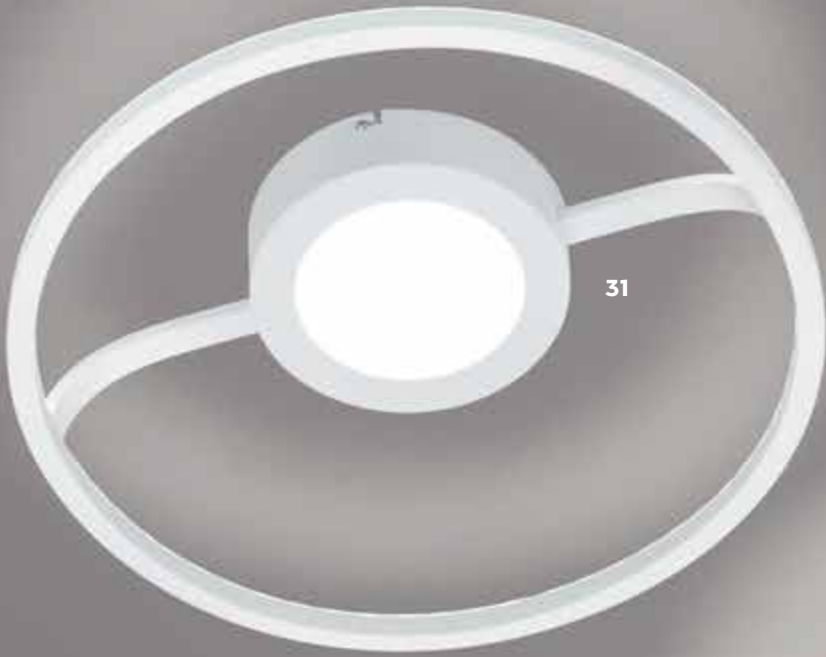

## CISCO

Nickel matt oder weiß matt · nickel mat or white mat ·  
nickel mat ou blanc mat · nikkell mat of wit mat · níquel mate o estera blanca ·  
nichel opaco o bianco opaco · nichel mat sau alb mat · harjattu teräs tai valkoinen matto ·  
nikiel mat lub biały mat · mat nikel veya beyaz mat

Gibt Licht nach oben und unten, getrennt schaltbar · up and down lighting, separately switchable ·  
point lumineux en haut et en bas, interrupteurs séparés · lichtpunt boven en onder, gescheiden schakelbaar ·  
luz de arriba y abajo, interruptores separados · luce su e giù, interruttori separati · sus și în jos lumina, intreruptoare separate ·  
ylös ja alas valoa, erikseen kytkettävissä · w górę i w dół światło, oddzielny przełącznik · yukarı ve aşağı ışık, dışarıdan anahtarlı



Ø 45 cm, ↑ 11 cm  
incl. 2 x SMD-LED, 11 W  
2 x 1.250 lm, 3.000 K



670010207  
670010231



07 Nickel matt · nickel mat  
31 weiß matt · white mat





## SAMBO

Nickel matt oder weiß matt · nickel mat or white mat ·  
nickel mat ou blanc mat · nikkell mat of wit mat · níquel mate o estera blanca ·  
nichel opaco o bianco opaco · nichel mat sau alb mat · harjattu teräs tai valkoinen matto ·  
nikiel mat lub biały mat · mat nikel veya beyaz mat

Gibt Licht nach oben und unten, getrennt schaltbar · up and down lighting, separately switchable ·  
point lumineux en haut et en bas, interrupteurs séparés · lichtpunt boven en onder, gescheiden schakelbaar ·  
luz de arriba y abajo, interruptores separados · luce su e giù, interruttori separati · sus și în jos lumina,  
intreruptoare separate · ylös ja alas valoa, erikseen kytkettävissä · w górę iw dół światło, oddzielny  
przełącznik · yukarı ve aşağı ışık, dışarıdan anahtarlı



↔ 45 x 45 cm, ↑ 11 cm  
incl. 2 x SMD-LED, 11 W  
2 x 1.250 lm, 3.000 K



670110207  
670110231



**07** Nickel matt · nickel mat  
**31** weiß matt · white mat

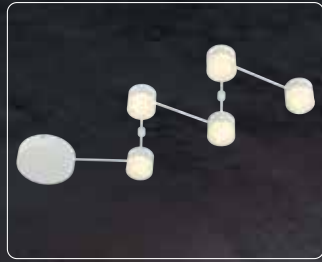
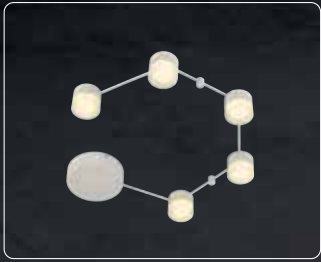

# NASHVILLE

Metall, Acryl · metal, acryl ·  
metale, acryl · metaal, acryl · metal, acrílico ·  
metallo, acrilico · metal, acrilic · metalli, akryyli ·  
metal, akryl · metal, akrilik

LED SWITCHDIMMER

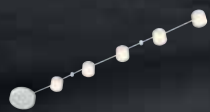
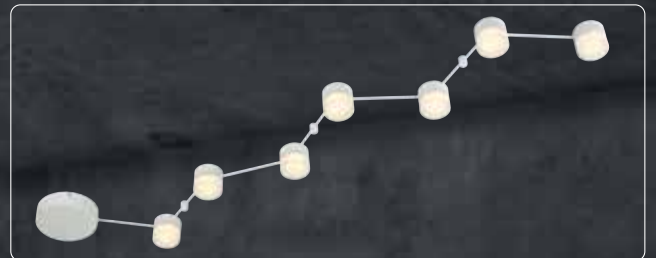
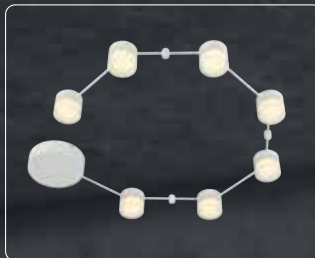

↔ max. 120 cm, ↑ 5,4 cm  
incl. 5 x SMD-LED, 3,5 W  
5 x 250 lm, 3.000 K



672410531

↔ max. 162 cm, ↑ 5,4 cm  
incl. 7 x SMD-LED, 3,5 W  
7 x 250 lm, 3.000 K



672410731



## INDIRA

Nickel matt, Acryl · nickel mat, acryl ·  
nickel mat, acryl · nikkell mat, acryl · níquel mate, acrílico ·  
nichel opaco, acrílico · nichel mat, acrílic · harjattu teräs, akryyli ·  
nikiel mat, akryl · mat nikel, akrilik

Gibt Licht nach oben und unten · up and down lighting ·  
point lumineux en haut et en bas · lichtpunt boven en onder ·  
luz de arriba y abajo · luce su e giù · sus și în jos lumina ·  
ylös ja alas valoa · w górę iw dół światło · yukarı ve aşağı ışık

### LED SWITCHDIMMER

↔ max. 245 cm, ↓ 6,5 cm  
incl. 3 x SMD-LED, 6 W  
3 x 650 lm, 3.000 K  
incl. 2 x SMD-LED, 3,5 W  
2 x 350 lm, 3.000 K



674610507

# SNAKE

Metall weiß matt · metal white mat ·  
metale blanc mat · metaal wit mat · metal estera blanca · metallo bianco opaco ·  
metal alb mat · metalli valkoinen matto · metal biały mat · metal beyaz mat

## LED SWITCHDIMMER



Seite/page 629



↔ 85 x 30 cm, ↗ 4 cm  
incl. SMD-LED, 16 W  
1.500 lm, 3.000 K



226811531



↔ 115 x 32,5 cm, ↗ 4 cm  
incl. SMD-LED, 20 W  
1.850 lm, 3.000 K



226812031





# HIGHWAY

Aluminium gebürstet · brushed aluminium ·  
aluminium balayé · geborsteld aluminium · aluminio pulido · alluminio spazzolato ·  
aluminium lucios · harjattu alumiini · aluminium szczotkowane · alüminyum



↔ 100 x 10 cm, ↑ 8,5 cm  
incl. 2 x SMD-LED, 11 W  
2 x 1.100 lm, 3.000 K



871810205



↔ 180 x 10 cm, ↑ 12 cm  
incl. 4 x SMD-LED, 11 W  
4 x 1.100 lm, 3.000 K



871810405



Ø 60 cm, ↑ 14 cm  
incl. 3 x SMD-LED, 6 W  
3 x 640 lm, 3.000 K



671810305



## CATOKI II

chrom, Acryl · chrome, acryl ·  
chrome, acryl · chroom, acryl · cromo, acrílico ·  
cromo, acrílico · crom, acrílic · kromi, akryyli ·  
chrom, akryl · krom, akrilik



↔ 88 x 15 cm, ↑ 8,5 cm  
incl. SMD-LED, 20 W  
1.800 lm, 3.000 K

A+

676712406



## BODRUM

chrom · chrome ·  
 chrome · chroom · cromo · cromo ·  
 crom · kromi · chrom · krom



310



Ø 65 cm, ↑ 8 cm  
 incl. 10 x SMD-LED, 2,1 W  
 10 x 200 lm, 3.000 - 6.500 K  
 incl. 1 x SMD-LED, 6,6 W  
 570 lm, 3.000 - 6.500 K



67331106

Ø 100 cm, ↑ 8,5 cm  
 incl. 12 x SMD-LED, 2,1 W  
 12 x 200 lm, 3.000 - 6.500 K  
 incl. 1 x SMD-LED, 6,6 W  
 570 lm, 3.000 - 6.500 K



673311306





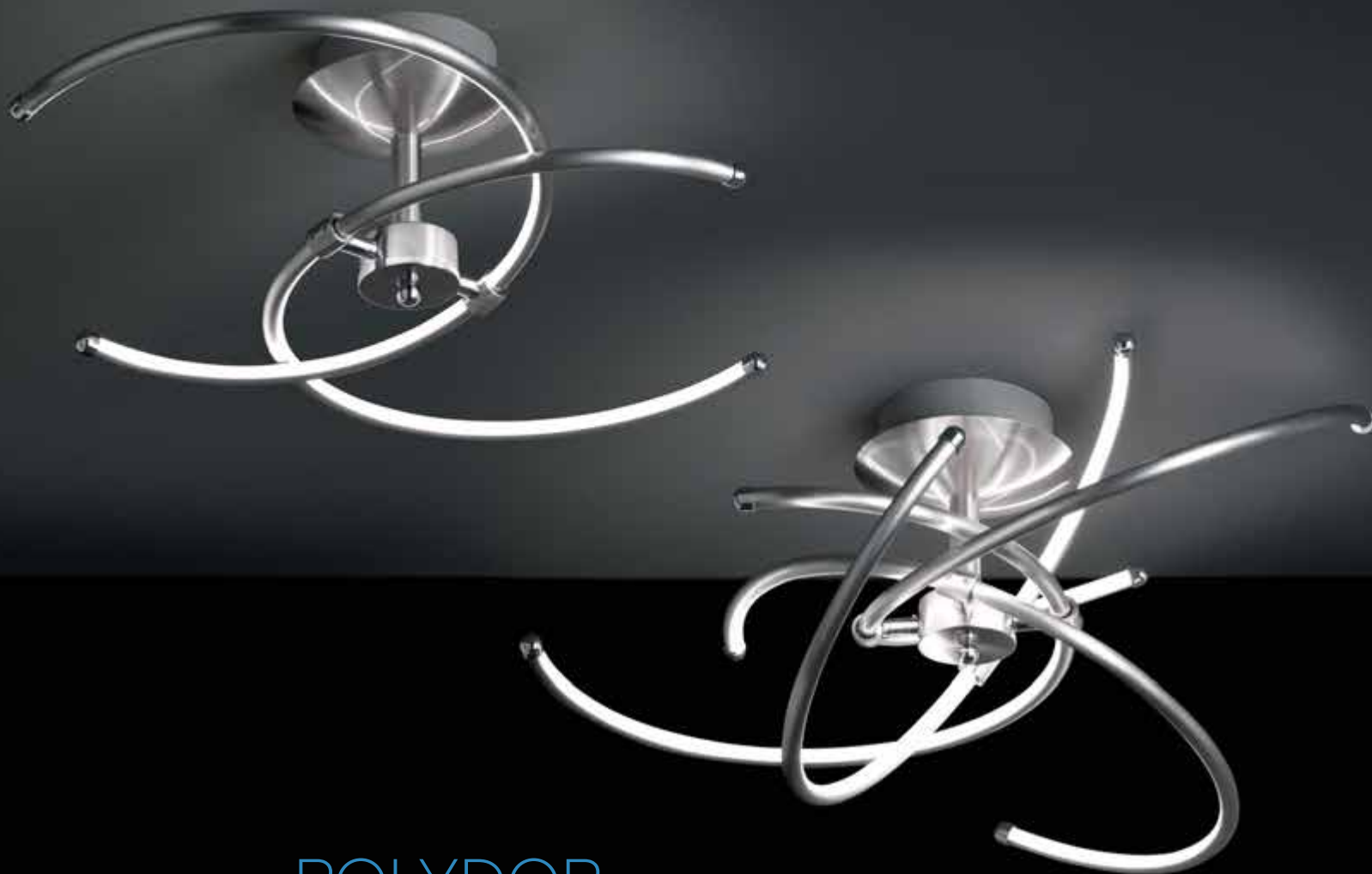

## POLYDOR

Nickel matt · nickel mat ·  
nickel mat · nikkell mat · níquel mate · nichel opaco ·  
nichel mat · harjattu teräs · nikiel mat · mat nikel

312



Ø 56 cm, ↑ 23,5 cm  
incl. 2 x SMD-LED, 6 W  
2 x 600 lm, 3.000 K



672710207



Ø 56 cm, ↑ 26 cm  
incl. 4 x SMD-LED, 6 W  
4 x 600 lm, 3.000 K



672710407



## TORINO

chrom, Kristallglas · chrome, crystalglass ·  
chrome, cristalverre · chroom, kristalglas ·  
cromo, cristalvidrio · cromo, cristallovetro ·  
crom, cristalsticla · kromi, kristallilasi ·  
chrom, kryształszkło · krom, camkumaş



313



Ø 50 cm, ↑ 8,5 cm  
incl. SMD-LED, 12,5 W  
1.250 lm, 3.000 K  
incl. 5 x SMD-LED, 4,5 W  
5 x 450 lm, 3.000 K

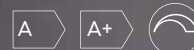

621513506



Ø 38 cm, ↑ 8 cm  
incl. SMD-LED, 10 W  
900 lm, 3.000 K  
incl. 5 x SMD-LED, 2,8 W  
5 x 340 lm, 3.000 K



621512406



## ANTONIO

chrom, Glas satiniert · chrome, satinated glass ·  
 chrome, verre satiné · chrom, gesatineerd glas · cromo, vidrio satinado ·  
 cromo, vetro satinato · crom, sticla satinata · kromi, satinoitu lasi ·  
 chrom, szkło satynowe · krom, satin cam



↔ 12 x 12 cm, ↗ 8 cm  
 incl. 1 x SMD-LED, 4,5 W  
 400 lm, 3.000 K



227970106

↔ 26 x 12 cm, ↗ 8 cm  
 incl. 2 x SMD-LED, 4,3 W  
 2 x 430 lm, 3.000 K



227970206

↔ 45 x 12 cm, ↗ 8 cm  
 incl. 4 x SMD-LED, 4,3 W  
 4 x 430 lm, 3.000 K



227970406

↔ 26 x 26 cm, ↑ 8 cm  
 incl. 4 x SMD-LED, 4,3 W  
 4 x 430 lm, 3.000 K



627910406

↔ 38 x 38 cm, ↑ 8 cm  
 incl. 5 x SMD-LED, 4,3 W  
 5 x 430 lm, 3.000 K



627910506



## PYRAMID

chrom, Glas satiniert · chrome, satinated glass ·  
chrome, verre satiné · chroom, gesatineerd glas · cromo, vidrio satinado ·  
cromo, vetro satinato · crom, sticla satinata · kromi, satinoitu lasi ·  
chrom, szkło satynowe · krom, satin cam



↔ 38 x 38 cm, ↓ 8 cm  
incl. 1 x SMD-LED, 18 W  
1.440 lm, 3.000 K



628611806



# CESAR

chrom, Acryl mit Kristalleffekt · chrome, broken glass optic ·  
 chrome, optique verre pilé · chroom, Gebroken glas optiek ·  
 cromo, Efecto cristal roto · cromo, effetto ottico vetro rotto ·  
 crom, aspect de sticla sparta · kromi, lasi efekti optiikka ·  
 chrom, Optyczne rozbite szkło · krom, Çatlatma cam

## LED SWITCHDIMMER

IP44



↔ 30 x 30 cm, ↓ 3 cm  
 incl. SMD-LED, 18 W  
 1.650 lm, 3.000 K



656511806

↔ 40 x 40 cm, ↓ 3 cm  
 incl. SMD-LED, 24 W  
 2.000 lm, 3.000 K



656512006

↔ 60 x 60 cm, ↓ 3 cm  
 incl. SMD-LED, 30 W  
 2.800 lm, 3.000 K



656513006

↔ 80 x 30 cm, ↓ 3 cm  
 incl. SMD-LED, 24 W  
 2.000 lm, 3.000 K



656512406



Ø 26 cm, ↑ 3 cm  
incl. SMD-LED, 15 W  
1.350 lm, 3.000 K



656411506



Ø 40 cm, ↑ 3 cm  
incl. SMD-LED, 24 W  
2.000 lm, 3.000 K



656412406



Ø 60 cm, ↑ 3 cm  
incl. SMD-LED, 30 W  
2.800 lm, 3.000 K



656413006

## LED SWITCHDIMMER

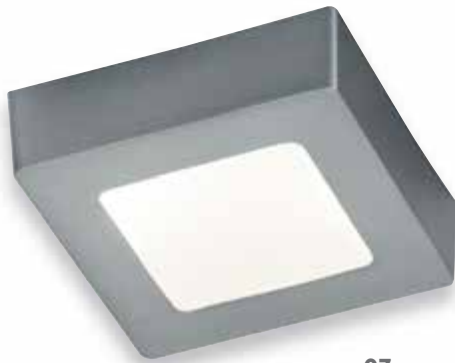

07

01

# ZEUS

Metall, Acryl · metal, acryl ·  
metale, acryl · metaal, acryl · metal, acrílico · metallo, acrilico ·  
metal, acrilic · metalli, akryyli · metal, akryl · metal, akrilik

318



↔ 12 x 12 cm, ↓ 3,5 cm  
incl. SMD-LED, 5,5 W  
450 lm, 3.000 K

A+

657110601  
657110607



↔ 17 x 17 cm, ↓ 3,5 cm  
incl. SMD-LED, 12,5 W  
1.100 lm, 3.000 K

A+

657111201  
657111207



↔ 22,5 x 22,5 cm, ↓ 3,5 cm  
incl. SMD-LED, 17 W  
1.600 lm, 3.000 K

A+

657111801  
657111807



↔ 40 x 40 cm, ↓ 6 cm  
incl. SMD-LED, 24 W  
2.100 lm, 3.000 K

A+



657112401  
657112407



01 weiß · white  
07 Nickel matt · nickel mat



## LED SWITCHDIMMER



07



01

# CENTO

Metall, Acryl · metal, acryl ·  
metale, acryl · metaal, acryl · metal, acrílico · metallo, acrilico ·  
metal, acrylic · metalli, akryyli · metal, akryl · metal, akrilik



Ø 12 cm, ↑ 3,5 cm  
incl. SMD-LED, 5,5 W  
450 lm, 3.000 K



657010601  
657010607



Ø 17 cm, ↑ 3,5 cm  
incl. SMD-LED, 11,5 W  
1.100 lm, 3.000 K



657011201  
657011207



Ø 22,5 cm, ↑ 3,5 cm  
incl. SMD-LED, 17 W  
1.600 lm, 3.000 K



657011801  
657011807



Ø 40 cm, ↑ 6 cm  
incl. SMD-LED, 24 W  
1.900 lm, 3.000 K



657012401  
657012407



**01** weiß · white  
**07** Nickel matt · nickel mat

LED SWITCHDIMMER



## PENTA

Dekorglas · glas decorated ·  
verre décoré · decoratief glas · vidrio decorado ·  
vetro decorato · sticla decorativa · ornamenttilasi ·  
szkło dekoracyjne · dekoratif cam

320



Ø 25 cm, ↑ 8,5 cm  
incl. SMD-LED, 8 W  
750 lm, 4.000 K

A

656310800

Ø 30 cm, ↑ 9,5 cm  
incl. SMD-LED, 12 W  
1.100 lm, 4.000 K

A

656311200

Ø 40 cm, ↑ 12 cm  
incl. SMD-LED, 20 W  
1.800 lm, 4.000 K

A+ 

656311800

LED SWITCHDIMMER

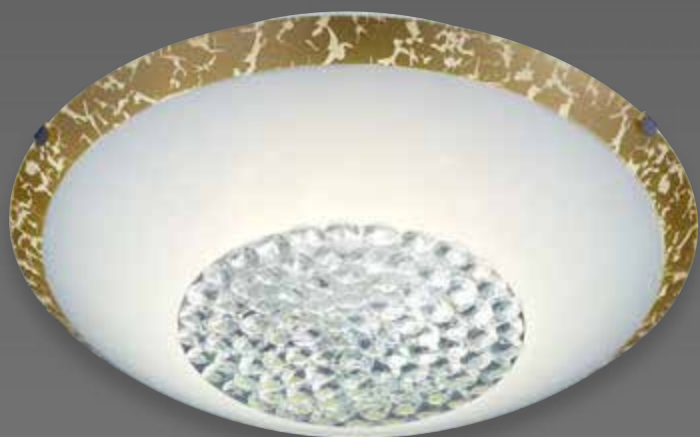

## COMTESS

Dekorglas · glas decorated ·  
verre décoré · decoratief glas · vidrio decorado ·  
vetro decorato · sticla decorativa · ornamenttilasi ·  
szkło dekoracyjne · dekoratif cam

321



Ø 25 cm, ↑ 8,5 cm  
incl. SMD-LED, 8 W  
750 lm, 3.000 K



656210800



Ø 30 cm, ↑ 9,5 cm  
incl. SMD-LED, 12 W  
1.100 lm, 3.000 K



656211200



Ø 40 cm, ↑ 12 cm  
incl. SMD-LED, 20 W  
1.800 lm, 3.000 K



656211800



## NICOLAS

chrom, Acryl · chrome, acryl ·  
 chrome, acryl · chroom, acryl · cromo, acrílico ·  
 cromo, acrilico · crom, acrilic · kromi, akryyli ·  
 chrom, akryl · krom, akrilik



## ALVARO

Nickel matt, Glas matt · nickel mat, mat glass ·  
 nickel mat, verre mat · nikkell mat, mat glas ·  
 níquel mate, vidrio mate · nichel opaco, vetro sabbiato ·  
 nichel mat, sticla mata · harjattu teräs, mattalasi ·  
 nikiel mat, szkło matowane · mat nikel, mat cam



Ø 31 cm, ↓ 9 cm  
 incl. SMD-LED, 12 W  
 1.050 lm, 3.000 K



624011206



Ø 42 cm, ↓ 10 cm  
 incl. SMD-LED, 25 W  
 2.000 lm, 3.000 K



624012306



Ø 30 cm, ↓ 9,5 cm  
 incl. 3 x SMD-LED, 4,5 W  
 3 x 400 lm, 3.000 K



625211007



LED SWITCHDIMMER

## STALYPSO

Nickel matt, Dekorglas · nickel mat, glass decorated ·  
 nickel mat, verre décoré · nikkell mat, decoratief glas ·  
 níquel mate, vidrio decorado · nichel opaco, vetro decorato ·  
 nichel mat, sticla decorativa · harjattu teräs, ornamenttilasi ·  
 nikiel mat, szkło dekoracyjne · mat nikel, dekoratif cam



LED SWITCHDIMMER

## ROMADOUR

Nickel matt, Dekorglas · nickel mat, glass decorated ·  
 nickel mat, verre décoré · nikkell mat, decoratief glas ·  
 níquel mate, vidrio decorado · nichel opaco, vetro decorato ·  
 nichel mat, sticla decorativa · harjattu teräs, ornamenttilasi ·  
 nikiel mat, szkło dekoracyjne · mat nikel, dekoratif cam



Ø 29 cm, ↓ 7 cm  
 incl. SMD-LED, 9 W  
 810 lm, 3.000 K



677410907



Ø 38 cm, ↓ 10,5 cm  
 incl. SMD-LED, 20 W  
 1.800 lm, 3.000 K

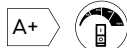

677412007



Ø 29 cm, ↓ 7 cm  
 incl. SMD-LED, 9 W  
 810 lm, 3.000 K



677310907



Ø 38 cm, ↓ 10,5 cm  
 incl. SMD-LED, 20 W  
 1.765 lm, 3.000 K

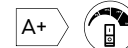

677312007



06



87

## PAGENO

Metall, Glas satiniert · metal, satinated glass ·  
 metale, verre satiné · metaal, gesatineerd glas · metal, vidrio satinado ·  
 metallo, vetro satinato · metal, sticla satinata · metalli, satinoitu lasi ·  
 metal, szkło satynowe · metal, satin cam



## PACCO

Metall, Dekorglas · metal, glas decorated ·  
 metale, verre décoré · metaal, decoratief glas ·  
 metal, vidrio decorado · metallo, vetro decorato ·  
 metal, sticla decorativa · metalli, ornamenttilasi ·  
 metal, szkło dekoracyjne · metal, dekoratif cam

## FACETTE

chrom, Facettenglas · chrome, faceted glass ·  
 chrome, verre à facettes · chroom, facet glas ·  
 cromo, cristal facetado · cromo, vetro sfaccettato ·  
 crom, sticlă fațetată · kromi, fasettihiottuja ·  
 chrom, szkło szlifowane · krom, yönlü cam



Ø 30 cm, ↑ 8 cm  
 incl. SMD-LED, 10 W  
 800 lm, 3.000 K

A+

677211006  
 677211087



Ø 30 cm, ↑ 8 cm  
 incl. SMD-LED, 10 W  
 800 lm, 3.000 K

A+

677111001



Ø 30 cm, ↑ 8 cm  
 incl. SMD-LED, 9 W  
 810 lm, 3.000 K

A+

629110106



01 weiß · white  
 06 chrom · chrome  
 87 titanfarbig · titanium-coloured



1



3



2

## GEMMA

Dekorglas · glas decorated · verre décoré · decoratief glas · vidrio decorado · vetro decorato · sticla decorativa · ornamentilasi · szkło dekoracyjne · dekoratif cam

**LED SWITCHDIMMER**

## CRISTALINA

Dekorglas · glas decorated · verre décoré · decoratief glas · vidrio decorado · vetro decorato · sticla decorativa · ornamentilasi · szkło dekoracyjne · dekoratif cam



1

Ø 30 cm, ↓ 9,5 cm  
incl. SMD-LED, 12 W  
900 lm, 3.000 K

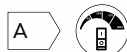

673611201



2

Ø 30 cm, ↓ 9,5 cm  
incl. SMD-LED, 12 W  
900 lm, 3.000 K

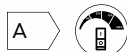

673511201



3

Ø 30 cm, ↓ 9,5 cm  
incl. SMD-LED, 12 W  
900 lm, 3.000 K



673411201



Ø 25 cm, ↓ 9,5 cm  
incl. SMD-LED, 10 W  
800 lm, 3.000 K



659611006



## JOEL

Kunststoff, weiß · plastic, white ·  
plastique, blanc · kunststof, wit · plástico, blanco ·  
plastica, bianco · plastic, alb · muovi, valkoinen ·  
plastik, biały · plastik, beyaz

326



Ø 29 cm, ↑ 5,4 cm  
incl. SMD-LED, 10 W  
730 lm, 3.000 K

A

627111001



Ø 33 cm, ↑ 5,4 cm  
incl. SMD-LED, 15 W  
1.100 lm, 3.000 K

A

627111501





87



01

327

# GONZALO

Kunststoff, weiß oder titanfarbig · plastic, white or titan ·  
plastique, blanc ou titane · kunststof, wit of titaan · plástico, blanco o títan ·  
plastica, bianco o titano · plastic, alb sau titaniu · muovi, valkoinen tai titaani ·  
plastik, biały lub tytanowy · plastik, beyaz veya titan



Ø 29 cm, ↑ 8 cm  
incl. SMD-LED, 9 W  
750 lm, 3.000 K



626510901  
626510987



Ø 34 cm, ↑ 9 cm  
incl. SMD-LED, 12 W  
1.050 lm, 3.000 K



626511201  
626511287



Ø 42 cm, ↑ 10 cm  
incl. SMD-LED, 25 W  
2.000 lm, 3.000 K



626512501  
626512587



01 weiß · white  
87 titanfarbig · titanium-coloured



## ADRIAN

Glas alabasterfarbig · alabaster-coloured glass ·  
verre couleur albâtre · albastkleurig glas ·  
vidrio de color alabastro · vetro colore alabastro ·  
sticla culoare alabastru · lasi alabasteri väri ·  
szkło alabaster kolor · cam kaymaktaşı rengi

328



Ø 30 cm, ↓ 9 cm  
excl. 1 x E27, max. 40 W

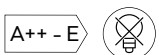

6105011-01



Ø 40 cm, ↓ 10 cm  
excl. 2 x E27, max. 40 W

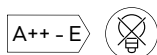

6105021-01



## BULTO

Nickel matt, Glas matt · nickel mat, mat glass ·  
nickel mat, verre mat · nikkell mat, mat glas ·  
níquel mate, vidrio mate · nichel opaco, vetro sabbiato ·  
nichel mat, sticla mata · harjattu teräs, mattalasi ·  
nikiel mat, szkło matowane · mat nikel, mat cam

329



Ø 29 cm, ↑ 11,7 cm  
excl. 1 x E27, max. 60 W

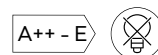

6107011-07



Ø 40 cm, ↑ 14,3 cm  
excl. 2 x E27, max. 60 W

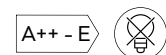

6107021-07



## ESPEJO

Spiegelglas, Glas satiniert · mirror glass, satinated glass ·  
 verre miroir, verre satiné · spiegelglas, gesatineerd glas · espejo de cristal, vidrio satinado ·  
 specchio, vetro satinato · sticla oglinda, sticla satinata · peililasi, satinoitu lasi ·  
 lustro szkło, szkło satynowe · ayna cam, satin cam



## FLORIS

Dekorglas · glas decorated ·  
 verre décoré · decoratief glas · vidrio decorado ·  
 vetro decorato · sticla decorativa · ornamentilasi ·  
 szkło dekoracyjne · dekoratif cam

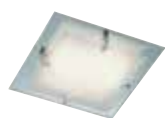

↔ 32 x 32 cm, ↓ 8,2 cm  
 excl. 2 x E14, max. 40 W

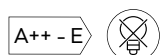

601100200



↔ 28,5 x 28,5 cm, ↓ 8,5 cm  
 excl. 1 x E27, max. 40 W

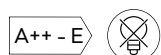

604200106



↔ 32,5 x 32,5 cm, ↓ 9 cm  
 excl. 2 x E27, max. 40 W

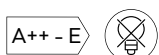

604200206



## CARBONADO

Dekorglas · glas decorated ·  
verre décoré · decoratief glas · vidrio decorado ·  
vetro decorato · sticla decorativa · ornamenttilasi ·  
szkło dekoracyjne · dekoratif cam



331



↔ 22 x 20 cm, ↗ 10 cm  
excl. 1 x E14, max. 40 W

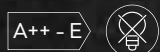

202400106



Ø 25 cm, ↓ 9,5 cm  
excl. 1 x E27, max. 40 W

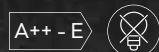

602400106



Ø 30 cm, ↓ 10,5 cm  
excl. 2 x E27, max. 40 W



602400206



Ø 40 cm, ↓ 10,5 cm  
excl. 3 x E27, max. 40 W



602400306



## CORMINT

Dekorglas · glas decorated ·  
verre décoré · decoratief glas · vidrio decorado ·  
vetro decorato · sticla decorativa · ornamentilasi ·  
szkło dekoracyjne · dekoratif cam

332



↔ 20 x 22 cm, ↗ 8 cm  
excl. 1 x E14, max. 40 W

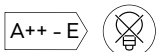

204000106



Ø 25 cm, ↓ 7,5 cm  
excl. 1 x E27, max. 40 W

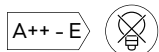

604000106



Ø 30 cm, ↓ 8,5 cm  
excl. 2 x E27, max. 40 W

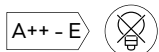

604000206



## ALBA

Dekorglas · glas decorated ·  
 verre décoré · decoratief glas · vidrio decorado ·  
 vetro decorato · sticla decorativa · ornamenttilasi ·  
 szkło dekoracyjne · dekoratif cam



## LUCIA

Dekorglas · glas decorated ·  
 verre décoré · decoratief glas · vidrio decorado ·  
 vetro decorato · sticla decorativa · ornamenttilasi ·  
 szkło dekoracyjne · dekoratif cam



Ø 25 cm, ↑ 8 cm  
 excl. 1 x E27, max. 40 WW

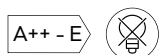

601900100



Ø 30 cm, ↑ 8,5 cm  
 excl. 2 x E27, max. 40 W

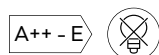

601900200



Ø 30 cm, ↑ 8 cm  
 excl. 2 x E14, max. 40 W

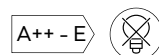

602600200



Ø 40 cm, ↑ 9 cm  
 excl. 2 x E27, max. 40 W

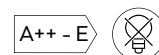

602700200

# NORA

Dekorglas · glas decorated · verre décoré · decoratief glas · vidrio decorado · vetro decorato · sticla decorativa · ornamenttilasi · szkło dekoracyjne · dekoratif cam



07 alabasterfarbig · alabaster-coloured

01 weiß matt · white mat



# LANA

Glas · glass · verre · glas · vidrio · vetro · sticla · lasi · szkło · cam



06 weiß satiniert · white satinated



00 opal · opal

01 alabasterfarbig · alabaster-coloured

# BUSA

Glas · glass · verre · glas · vidrio · vetro · sticla · lasi · szkło · cam



Ø 25 cm, ↑ 8 cm  
excl. 1 x E27, max. 40 W

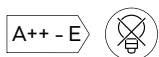

602100100



Ø 30 cm, ↑ 8,5 cm  
excl. 2 x E27, max. 40 W

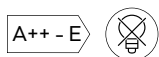

602100200



Ø 25 cm, ↑ 8 cm  
excl. 1 x E27, max. 40 W

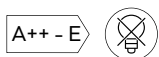

6196011-01  
6196011-07



↔ 23 x 23 cm, ↑ 7,5 cm  
excl. 1 x E27, max. 40 W

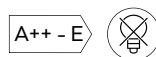

601400100  
601400101  
601400106



## CHICO

Glas · glass ·  
verre · glas · vidrio · vetro ·  
sticla · lasi · szkło · cam



07



01



06

## PRIMO

Metall, Glas · metal, glass ·  
metale, verre · metaal, glas · metal, vidrio · metallo, vetro ·  
metal, sticla · metalli, lasi · metal, szkło · metal, cam



Ø 30 cm, ↑ 7,5 cm  
excl. 1 x E27, max. 60 W

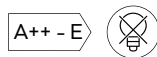

6160011-00



Ø 30 cm, ↑ 7,5 cm  
excl. 1 x E27, max. 60 W

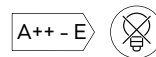

6101011-01  
6101011-06  
6101011-07



**01** weiß · white  
**06** chrom · chrome  
**07** Nickel matt · nickel mat



## CURVA

Nickel matt, Glas matt · nickel mat, mat glass ·  
 nickel mat, verre mat · nikkell mat, mat glas · níquel mate, vidrio mate ·  
 nichel opaco, vetro sabbaiato · nichel mat, sticla mata · harjattu teräs, mattalasi ·  
 nikiel mat, szkło matowane · mat nikel, mat cam



↔ 50 x 20 cm, ↓ 27 cm  
 excl. 3 x E14, max. 40 W

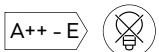

605600307



↔ 72 x 28 cm, ↓ 27 cm  
 excl. 5 x E14, max. 40 W

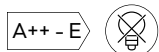

605600507

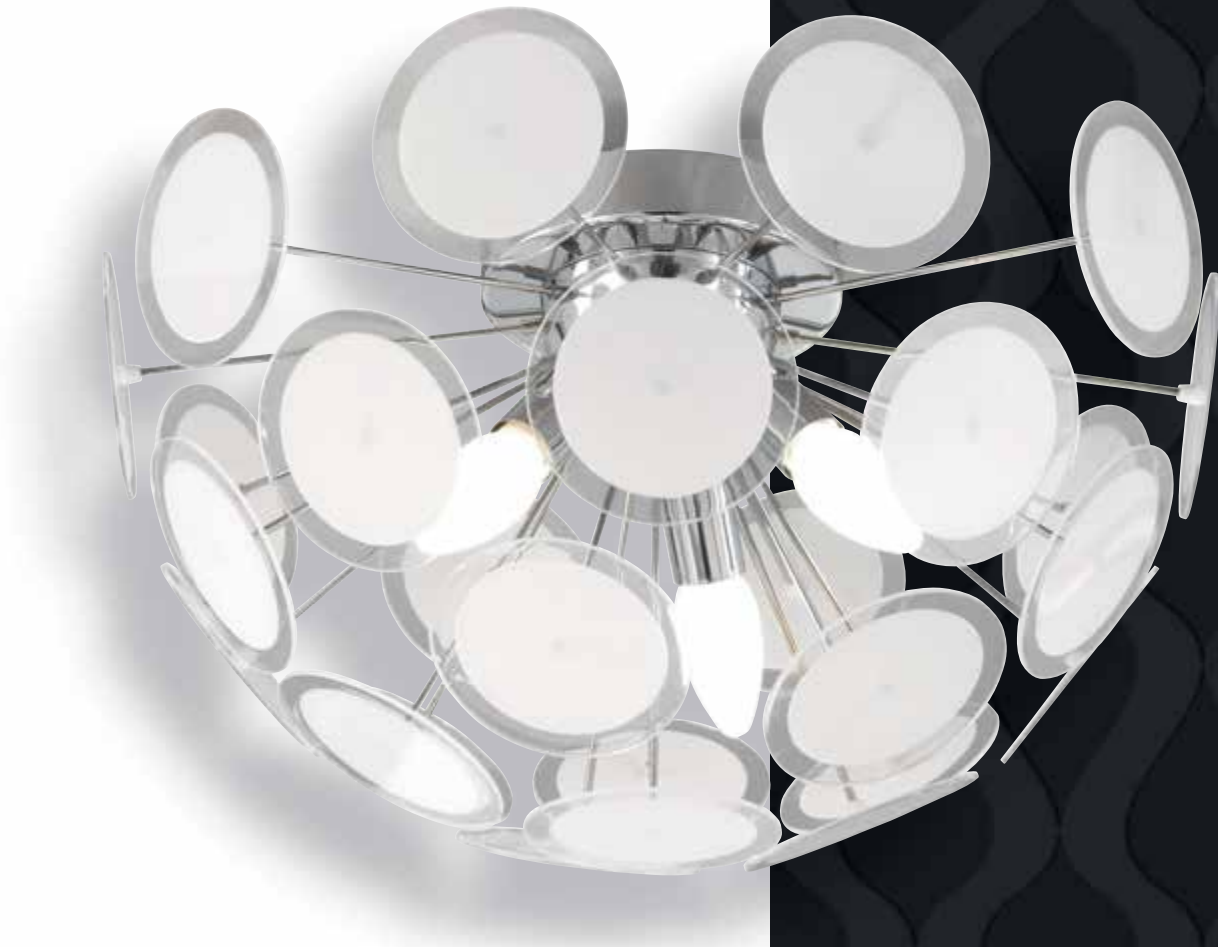

## DISC

chrom, Acryl · chrome, acryl ·  
chrome, acryl · chroom, acryl · cromo, acrílico · cromo, acrilico ·  
crom, acrylic · kromi, akryyli · chrom, akryl · krom, akrilik

337



Ø 45 cm, ↑ 25 cm  
excl. 3 x E14, max. 40 W

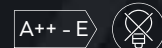

609000306

28



338



Ø 80 cm, ↑ 10,5 cm  
incl. 15 x SMD-LED, 1 W  
15 x 90 lm, 3.000 K



622811527  
622811528



27 weiß antik · antique white  
28 rostfarbig antik · antique rust

27



## REPOSA

weiß antik oder rostfarbig antik, Glas matt · antique white or antique rust, mat glass ·  
blanc antique ou rouille antique, verre mat · antiek wit of roestkleur antiek, mat glas · blanco decapé o oxido,  
vidrio mate · bianco anticato o ruggine anticato, vetro sabbiato · alb antic sau ruginiu antic, sticla mata ·  
antiikkivalkoinen tai rustiikki, mattalasi · antyczny biały lub antyczny rdzawy, szkło matowane · antik beyaz  
veya antik pas rengi, mat cam





# DOLPHIN

Nickel matt oder goldfarbig · nickel mat or gold ·  
 nickel mat ou or · nikkell mat of goud · níquel mate o oro ·  
 nichel opaco o oro · nichel mat sau aur · harjattu teräs tai kultaa ·  
 nikiel mat lub złota · mat nikel veya altın

LED SWITCHDIMMER



↔ 55 x 18 cm, ↑ 8,5 cm  
 incl. 3 x SMD, 3,6 W  
 3 x 380 lm, 3.000 K



677010307  
 677010379

↔ 85 x 20 cm, ↑ 8,5 cm  
 incl. 5 x SMD, 3,5 W  
 5 x 380 lm, 3.000 K



677010507  
 677010579

Ø 45 cm, ↑ 8,5 cm  
 incl. 6 x SMD, 3,6 W  
 6 x 380 lm, 3.000 K



677010607  
 677010679



**07** Nickel matt · nickel mat  
**79** goldfarbig · gold



## CLEO

Metall, goldfarbig · metal, gold ·  
metale, or · metaal, goud · metal, oro ·  
metallo, oro · metal, aur · metalli, kultaa ·  
metal, złota · metal, altın

Empfohlen:  
recommended: LED GU10, 5 W  
400 lm, 3.000 K



956-55



## AURORA

Metall, goldfarbig · metal, gold ·  
metale, or · metaal, goud · metal, oro ·  
metallo, oro · metal, aur · metalli, kultaa ·  
metal, złota · metal, altın

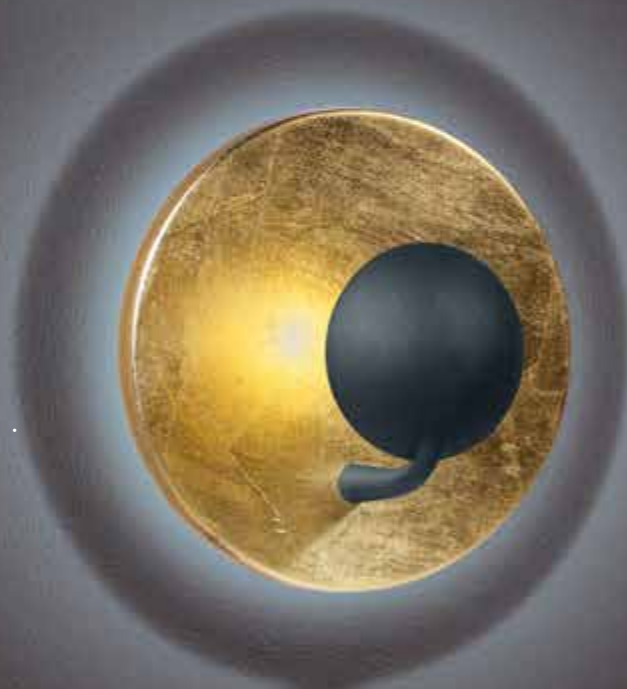

↗ 12 cm, Ø 20 cm  
incl. 1 x SMD-LED, 3,2 W, 300 lm  
incl. 1 x SMD-LED, 3 W, 200 lm  
3.000 K



223810279



↑ max. 50 cm, Ø 36 cm  
incl. 1 x SMD-LED, 19 W  
1.700 lm, 3.000 K



323810179



↑ 16,5 x 6 cm, ↗ 10 cm  
excl. 2 x GU10, max. 35 W



206400279



↑ 15 x 8 cm, ↗ 8 cm  
excl. 2 x GU10, max. 35 W



206500279





## ZENIT

Metall, goldfarbig, Acryl · metal, gold, acryl ·  
metale, or, acryl · metaal, goud, acryl ·  
metal, oro, acrílico · metallo, oro, acrilico ·  
metal, aur, acrilic · metalli, kultaa, akryyli ·  
metal, złota, akryl · metal, altın, akrilik



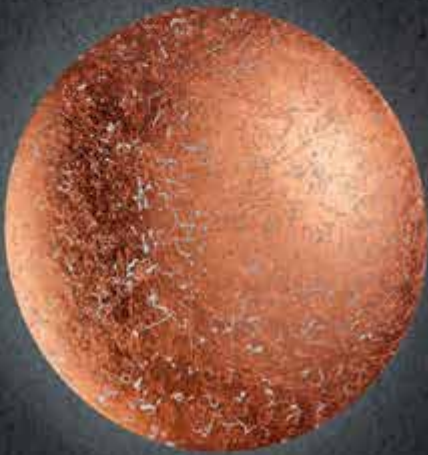

09



89



79

344



Ø 22 cm, ↗ 6,5 cm  
incl. 1 x SMD-LED, 8 W  
800 lm, 3.000 K

Ø 32 cm, ↑ 6 cm  
incl. 1 x SMD-LED, 12 W, 1.100 lm  
incl. 1 x SMD-LED, 3,5 W, 350 lm  
3.000 K

A+

A+



224110109  
224110179  
224110189

624110209  
624110279  
624110289

09 kupferfarbig · copper  
79 goldfarbig · gold  
89 silberfarbig · silver

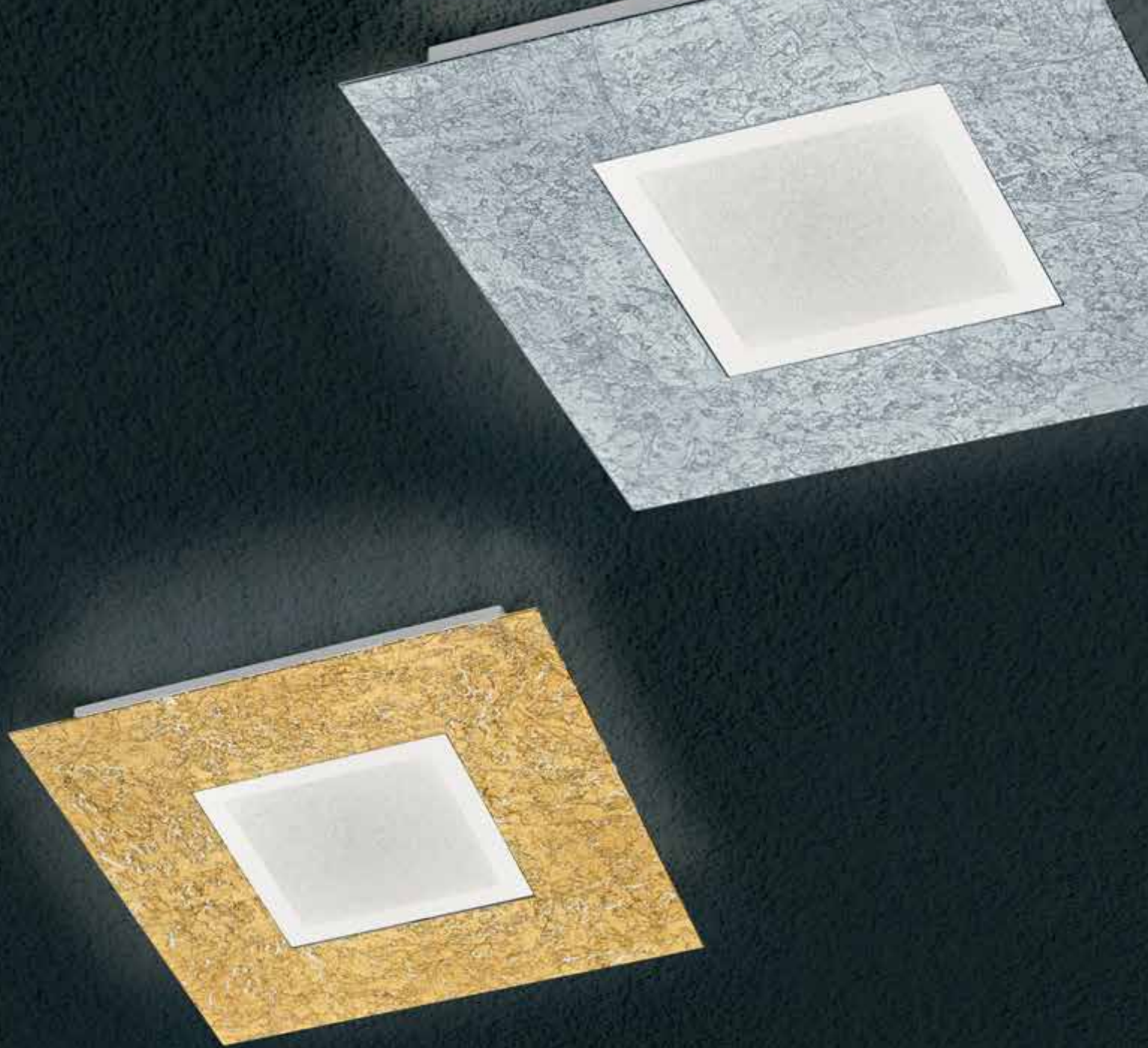

# CHIROs

Metall, Glas satiniert · metal, satinated glass ·  
 metale, verre satiné · metaal, gesatineerd glas · metal, vidrio satinado ·  
 metallo, vetro satinato · metal, sticla satinata · metalli, satinoitu lasi ·  
 metal, szkło satynowe · metal, satin cam



↔ 30 x 30 cm, ↑ 4 cm  
 incl. 1 x SMD-LED, 12 W, 1.100 lm  
 incl. 1 x SMD-LED, 3,5 W, 350 lm  
 3.000 K



**624210209**  
**624210279**  
**624210289**



**09** kupferfarbig · copper  
**79** goldfarbig · gold  
**89** silberfarbig · silver

89



79



## VANCOUVER

Glas, weiß, silberfarbig oder goldfarbig ·  
 glass, white, silver or gold · verre, blanc, argent ou or · glas, wit, zilver of goud ·  
 vidrio, blanco, plata o oro · vetro, bianco, argento o oro · sticla, alb, argint sau aur ·  
 lasi, valkoinen, hopea tai kultaa · szkło, biały, srebrny lub złota · cam, beyaz, gümüş veya altın



Ø 50 cm, ↑ 8,5 cm  
 incl. SMD-LED, 30 W  
 2.580 lm, 3.000 K



656813079  
 656813089



Ø 40 cm, ↑ 8,5 cm  
 incl. SMD-LED, 20 W  
 1.720 lm, 3.000 K



656812079  
 656812089



79 goldfarbig · gold  
 89 silberfarbig · silver

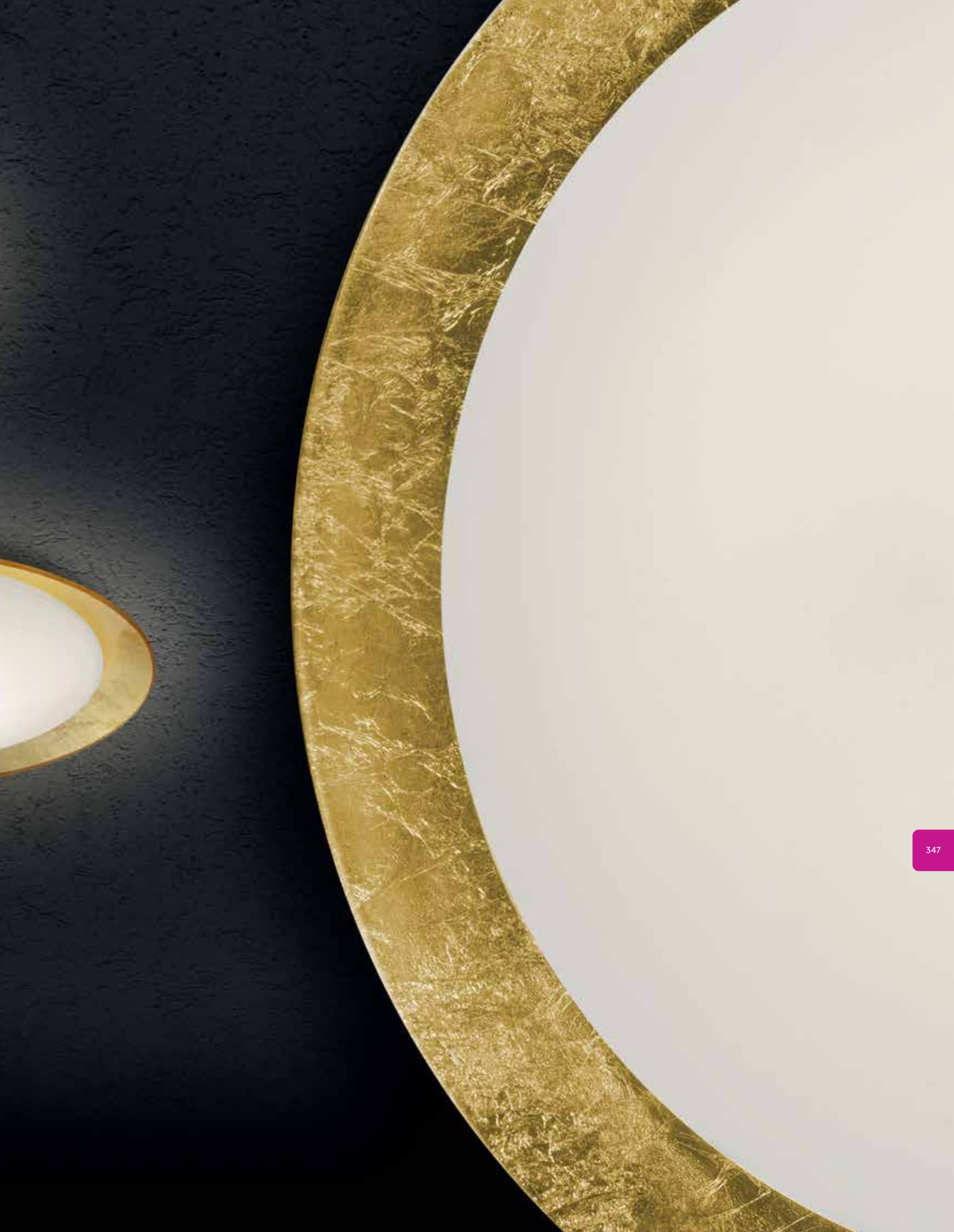



## MILANO

Glas opal · opal glass  
verre opale · opaal glas · vidrio opal · vetro opale ·  
sticla opala · opaalilasi · szkło opal · opal cam



## ALABASTER

Glas alabasterfarbig · alabaster-coloured glass  
verre couleur albâtre · albastkleurig glas · vidrio de color alabastro ·  
vetro colore alabastro · sticla culoare alabastru · lasi alabasteri väri ·  
szkło alabaster kolor · cam kaymaktaşı rengi



Ø 40 cm, ↑ 9,5 cm  
incl. SMD-LED, 30 W  
2.580 lm, 3.000 K



656613001



Ø 32 cm, ↑ 8,5 cm  
incl. SMD-LED, 20 W  
1.720 lm, 3.000 K



656612001



Ø 45 cm, ↑ 11,5 cm  
incl. SMD-LED, 30 W  
2.580 lm, 3.000 K



656713001



Ø 36 cm, ↑ 11,5 cm  
incl. SMD-LED, 20 W  
1.720 lm, 3.000 K



656712001

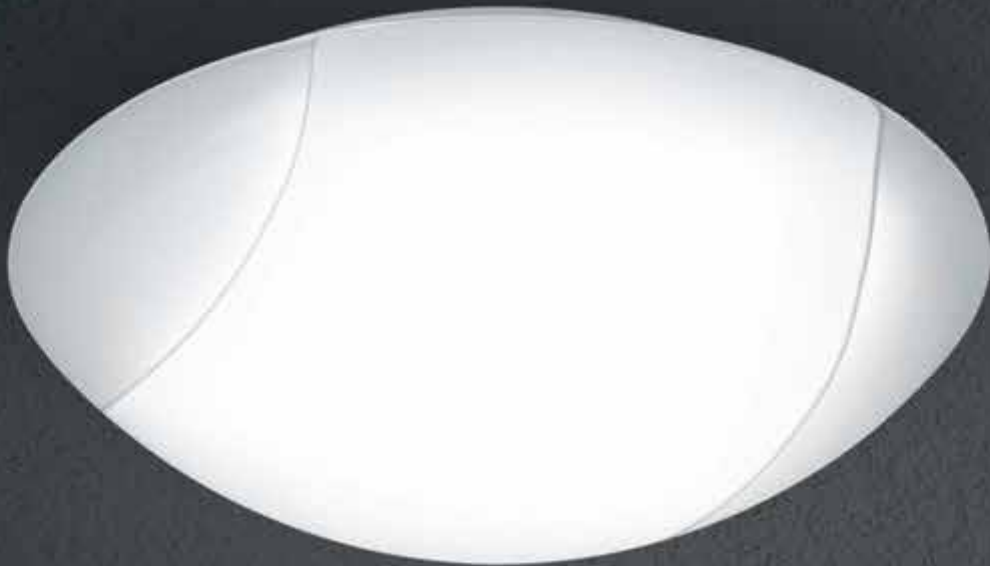

## ONTARIO

Glas opal · opal glass  
verre opale · opaal glas · vidrio opal ·  
vetro opale · sticla opala · opaalilasi ·  
szkło opal · opal cam



Ø 40 cm, ↑ 13,5 cm  
incl. SMD-LED, 30 W  
2.580 lm, 3.000 K



655213031



Ø 32 cm, ↑ 12 cm  
incl. SMD-LED, 20 W  
1.720 lm, 3.000 K



655212031



01

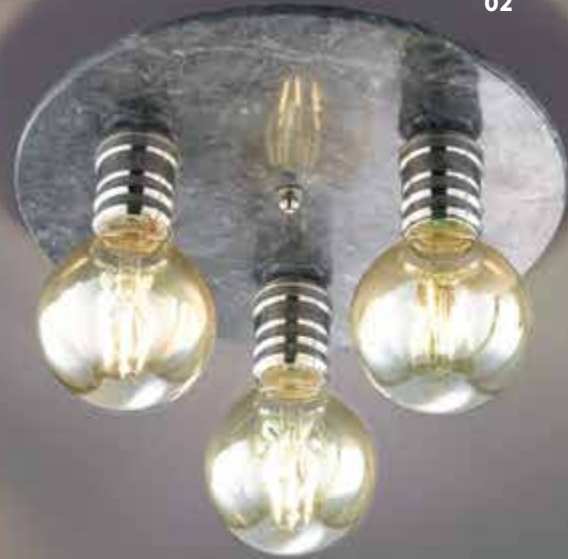

02

## CLAIRE

Empfohlen:  
recommended: Filament LED E27, 6 W  
420 lm, 2.700 K



A+

988-679

Leuchten aus echtem Marmor bestechen durch die natürliche und einzigartige Maserung, die jede Leuchte zu einem Unikat macht ·

Luminaires made of real marble impress with their natural and unique pattern, which makes every lamp to one of a kind ·

Luminaires en marbre véritable. Le grain naturel qui les constitue donne à chaque lampe une apparence propre et rend chaque modèle unique ·

Armaturen gemaakt van echt marmer hebben een eigen natuurlijke tekening, die elke lamp uniek maakt ·

Las luminarias de mármol genuino impresionan por su veta natural y única que hace que cada lámpara sea diferente ·

Gli apparecchi, realizzati in marmo, colpiscono con il loro grano naturale, che rende ogni lampada unica ·

Corpurile de iluminat facute din marmura adevarata impresioneaza cu granulatia lor unica si naturala ,care face din fiecare lampa un unicat ·

Valaisimet jotka on tehty oikeasta marmorista tekevät vaikutuksen niiden luonnollisella ja yksilöllisellä kuvioinnilla joka tekee jokaisesta kappaleesta yksilöllisen sekä ainutlaatuisen ·

Oprawy wykonane z prawdziwego marmuru zachwyca naturalny i niepowtarzalny mazerunek, który sprawia, że każda lampa jest jedyna w swoim rodzaju ·

Her bir ürünü eşsiz kılan doğal dokusuyla etkileyici gerçek mermerden yapılmış aydınlatma ürünleri.



Ø 30 cm, ↑ 11,5 cm  
excl. 3 x E27, max. 40 W

A++ - E



604300301  
604300302

01 weiß · white  
02 schwarz · black





## QUINTA

rostfarbig, Glas alabasterfarbig · rusty, alabaster-coloured glass ·  
rouille, verre couleur albâtre · roestkleur, albastkleurig glas ·  
óxido, vidrio de color alabastro · ruggine, vetro colore alabastro ·  
ruginiu, sticla culoare alabastru · rustiikki, lasi alabasteri väri ·  
miedź, szkło alabaster kolor · pas, cam kaymaktaşu rengi



Ø 33 cm, ↓ 20 cm  
excl. 2 x E27, max. 40 W

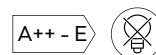

608100224



Ø 42 cm, ↓ 32 cm  
excl. 3 x E27, max. 60 W

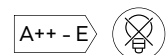

608100324



87



01



14

# EMBASSY

Stoff, Acryl · fabric, acryl ·  
tissu, acryl · textiel, acryl · tela, acrílico · tessuto, acrilico ·  
textil, acrilic · tekstiili, akryyli · tkanina, akryl · kumaş, akrilik



↔ 30 x 30 cm, ↓ 16 cm  
excl. 2 x E14, max. 40 W

↔ 50 x 50 cm, ↓ 17 cm  
excl. 4 x E27, max. 60 W

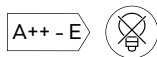
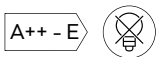

603800201  
603800214  
603800287

603800401  
603800414  
603800487

01 weiß · white  
14 braun · brown  
87 grau · grey

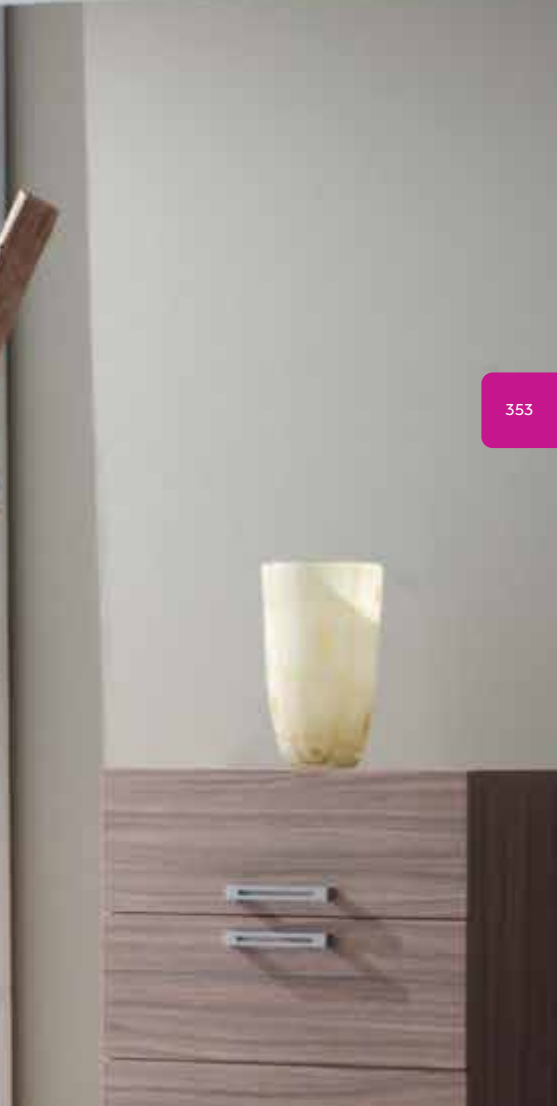



31



32

## LUIGI

Metall, weiß matt oder schwarz matt · metal, white mat or black mat ·  
 metale, blanc mat ou noir mat · metaal, wit mat of mat zwart ·  
 metal, estera blanca o estera negra · metallo, bianco opaco o nero opaco ·  
 metal, alb mat sau negru mat · metalli, valkoinen matto tai musta matto ·  
 metal, biały mat lub czarny mat · metal, beyaz mat veya siyah mat

Getrennt schaltbar · Separately switchable  
 Interrupteurs séparés · Gescheiden schakelbaar · Interruptores separados ·  
 Interruttori separati · Intreruptoare separate · Erikseen kytkettävissä ·  
 Oddzileny przełącznik · Dışarıdan anahtarlı



Seite/page 629



↑ 20 x 13,5 cm, ↗ 11 cm  
 incl. 1 x SMD-LED, 5 W  
 500 lm, 3.000 K  
 incl. 1 x SMD-LED, 2,3 W  
 200 lm, 3.000 K



222270231  
 222270232



**01** weiß matt · white mat  
**32** schwarz matt · black mat



## MARIO

Metall, weiß matt oder schwarz matt · metal, white mat or black mat ·  
metale, blanc mat ou noir mat · metaal, wit mat of mat zwart ·  
metal, estera blanca o estera negra · metallo, bianco opaco o nero opaco ·  
metal, alb mat sau negru mat · metalli, valkoinen matto tai musta matto ·  
metal, biały mat lub czarny mat · metal, beyaz mat veya siyah mat

Getrennt schaltbar · Separately switchable  
Interrupteurs séparés · Gescheiden schakelbaar · Interruptores separados ·  
Interruttori separati · Intreruptoare separate · Erikseen kytkettävissä ·  
Oddzileny przełącznik · Dışarıdan anahtarlı

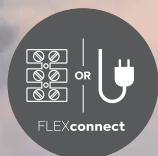

Seite/page 629



Ø 16 cm, ∅ 10,5 cm  
incl. 1 x SMD-LED, 6 W  
600 lm, 3.000 K  
incl. 1 x SMD-LED, 2,3 W  
200 lm, 3.000 K



222370231  
222370232



**31** weiß matt · white mat  
**32** schwarz matt · black mat



Getrennt schaltbar · Separately switchable  
 Interrupteurs séparés · Gescheiden schakelbaar ·  
 Interruptores separados · Interruttori separati ·  
 Interrupatoare separate · Erikseen kytkettävissä ·  
 Oddzielny przełącznik · Dışarıdan anahtarlı



↑ 30 x 14 cm, ↗ 18 cm  
 incl. 1 x SMD-LED, 4 W  
 400 lm, 3.000 K  
 excl. 1 x E27, max. 40 W

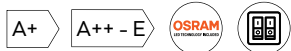

271470207  
 271470279

07 Nickel matt · nickel mat  
 79 goldfarbig · gold

## MARRIOT

Nickel matt oder goldfarbig, Stoffschirm · nickel mat or gold, fabric shade ·  
nickel mat ou or, abat-jour tissu · nikkell mat of goud, Stoffen kap · níquel mate o oro, Pantalla de tela ·  
nichel opaco o oro, paralume in tessuto · nichel mat sau aur, abajur textil · harjattu teräs tai kultaa, kangas varjostin ·  
nikiel mat lub złota, Klosz z materiału · mat nikel veya altın, Kumaş şapka



Seite/page 629



28



07

## BOLERO

Metall · metal ·  
metale · metaal · metal · metallo ·  
metal · metalli · metal · metal



↑ 38 x 6 cm, √ 8 cm  
incl. 2 x SMD-LED, 3,2 W  
2 x 300 lm, 3.000 K

A+



221570207  
221570228

**07** Nickel matt · nickel mat  
**28** rostfarbig antik · antique rusty





32

# LACAPO

Metall · metal ·  
metale · metaal · metallo ·  
metal · metalli · metal · metal



07



31

↔ 10,5 cm, ↑ 6 cm, ↗ 15 cm  
incl. SMD-LED, 4,5 W  
430 lm, 3.000 K



223410107  
223410131  
223410132

**07** Nickel matt · nickel mat  
**31** weiß matt · white mat  
**32** schwarz matt · black mat



07



01

# ROTARIO

Metall · metal ·  
metale · metaal · metal · metallo ·  
metal · metalli · metal · metal



↔ 14 x 14 cm, √ 6 cm  
incl. 2 x SMD-LED, 5 W  
2 x 450 lm, 3.000 K



223170201  
223170207

01 weiß · white  
07 Nickel matt · nickel mat





05



32



31

## LOUIS

Metall · metal ·  
metale · metaal · metallo · metal ·  
metalli · metal · metal



↑ 10 x 10 cm, ↗ 10 cm  
incl. 1 x OSRAM-LED, 4,5 W  
430 lm, 3.000 K



223310105  
223310131  
223310132

**05** Aluminium gebürstet · brushed aluminium  
**31** weiß matt · white mat  
**32** schwarz matt · black mat

# ADRIANO

Aluminium gebürstet oder weiß · brushed aluminium or white · aluminium balayé ou blanc · geborsteld aluminium of wit · aluminio pulido o blanco · alluminio spazzolato o bianco · aluminiu lucios sau alb · harjattu alumiini tai valkoinen · aluminium szczotkowane lub biały · alüminyum veya beyaz

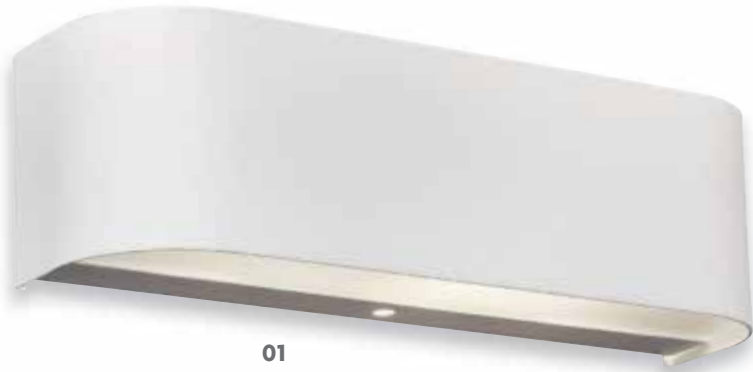

01



05



05



06

# DARCO

Aluminium gebürstet oder chrom · brushed aluminium or chrome · aluminium balayé ou chrome · geborsteld aluminium of chrom · aluminio pulido o cromo · alluminio spazzolato o cromo · aluminiu lucios sau crom · harjattu alumiini tai kromi · aluminium szczotkowane lub chrom · alüminyum veya krom



↔ 30 x 6 cm, √ 8 cm  
incl. 2 x SMD-LED, 3,2 W  
2 x 300 lm, 3.000 K



220810201  
220810205

↔ 25 x 7 cm, √ 6,5 cm  
incl. 2 x SMD-LED, 3 W  
2 x 280 lm, 3.000 K



225770205  
225770206



01 weiß · white  
05 Aluminium gebürstet · brushed aluminium  
06 chrom · chrome



06

## ESCALATE

chrom oder Aluminium gebürstet · chrome or brushed aluminium ·  
chrome ou aluminium balayé · chrom of geborsteld aluminium · cromo o aluminio pulido ·  
cromo o alluminio spazzolato · crom sau aluminu lucios · kromi tai harjattu alumiini ·  
chrom lub aluminium szczotkowane · krom veya alüminyum



05

363



↔ 33,7 x 6,7 cm, ∇ 5,3 cm  
incl. 2 x SMD-LED, 3,8 W  
2 x 380 lm, 3.000 K

A+



222410205  
222410206

05 Aluminium gebürstet · brushed aluminium  
06 chrom · chrome

# CUBE

Beton · concrete ·  
béton · beton · hormigón · cemento ·  
beton · betoni · beton · beton

Empfohlen:  
recommended: LED GU10, 5 W  
400 lm, 3.000 K



956-55



# ENRICO

Nickel matt · nickel mat ·  
nickel mat · nikkell mat · níquel mate · nichel opaco ·  
nichel mat · harjattu teräs · nikiel mat · mat nikel

Empfohlen:  
recommended: LED GU10, 5 W  
400 lm, 3.000 K



956-55



364



↑ 15 cm, ↔ 10 x 10 cm  
excl. 1 x GU10, max. 35 W



606600178



↑ 15 x 10 cm, ↗ 9 cm  
excl. 2 x GU10, max. 35 W



206600278



↑ 15 x 8 cm, ↗ 8 cm  
excl. 2 x GU10, max. 35 W



261100207



07 Nickel matt · nickel mat  
78 betonfarbig · concrete look



## WALES

Nickel matt · nickel mat ·  
nickel mat · nikkell mat ·  
níquel mate · nichel opaco ·  
nichel mat · harjattu teräs ·  
nikiel mat · mat nikel



## ABERDEEN

Nickel matt · nickel mat ·  
nickel mat · nikkell mat · níquel mate · nichel opaco ·  
nichel mat · harjattu teräs · nikiel mat · mat nikel



↔ 20 cm, ↑ 8 cm, ↗ 7 cm  
incl. 6 x SMD-LED, 1 W  
6 x 100 lm, 3.000 K



225610607



↔ 9 cm, ↑ 9 cm, ↗ 6 cm  
incl. 2 x SMD-LED, 3,2 W  
2 x 300 lm, 3.000 K



225510207

## ZITA

Nickel matt, weiß matt oder schwarz matt · nickel mat, white mat or black mat ·  
 nickel mat, blanc mat ou noir mat · nikkell mat, wit mat of mat zwart ·  
 níquel mate, estera blanca o estera negra · nichel opaco, bianco opaco o nero opaco ·  
 nichel mat, alb mat sau negru mat · harjattu teräs, valkoinen matto tai musta matto ·  
 nikiel mat, biały mat lub czarny mat · mat nikel, beyaz mat veya siyah mat

↑ 60 x 10 cm, ↗ 6,5 cm  
 incl. 1 x SMD-LED, 6 W  
 480 lm, 3.000 K



225870107  
 225870131  
 225870132



**07** Nickel matt · nickel mat  
**31** weiß matt · white mat  
**32** schwarz matt · black mat









07

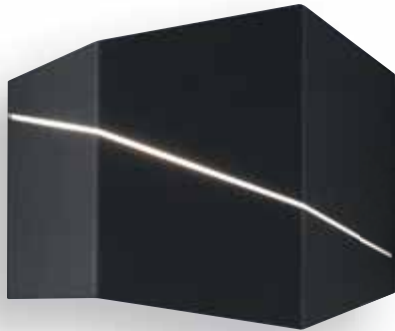

32

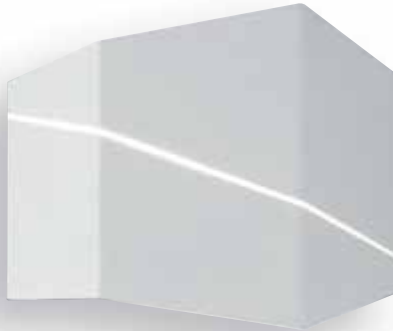

31



## ZORRO

Nickel matt, weiß matt oder schwarz matt · nickel mat, white mat or black mat ·  
 nickel mat, blanc mat ou noir mat · nikkell mat, wit mat of mat zwart ·  
 níquel mate, estera blanca o estera negra · nichel opaco, bianco opaco o nero opaco ·  
 nichel mat, alb mat sau negru mat · harjattu teräs, valkoinen matto tai musta matto ·  
 nikiel mat, biały mat lub czarny mat · mat nikel, beyaz mat veya siyah mat

368



↔ 18 x 14,5 cm, √ 6,5 cm  
 incl. 1 x SMD-LED, 6,5 W  
 500 lm, 3.000 K

A+

223210107  
 223210131  
 223210132



↔ 40 x 18 cm, √ 6,5 cm  
 incl. 1 x SMD-LED, 13 W  
 1.000 lm, 3.000 K

A+

223210207  
 223210231  
 223210232



**07** Nickel matt · nickel mat  
**31** weiß matt · white mat  
**32** schwarz matt · black mat





## VALERIO

Nickel matt, Acryl · nickel mat, acryl ·  
nickel mat, acryl · nikkell mat, acryl ·  
níquel mate, acrílico · nichel opaco, acrilico ·  
nichel mat, acrilic · harjattu teräs, akryyli ·  
nikiel mat, akryl · mat nikel, akrilik



## DENVER

Nickel matt, Acryl · nickel mat, acryl ·  
nickel mat, acryl · nikkell mat, acryl · níquel mate, acrílico · nichel opaco, acrilico ·  
nichel mat, acrilic · harjattu teräs, akryyli · nikiel mat, akryl · mat nikel, akrilik



Ø 6 cm, ↑ 16,5 cm, ↗ 10 cm  
incl. 2 x SMD-LED, 3,2 W  
2 x 300 lm, 3.000 K



222970207



↔ 13 x 13 cm, ↗ 13 cm  
incl. 2 x SMD-LED, 4,3 W  
2 x 460 lm, 3.000 K



279670207

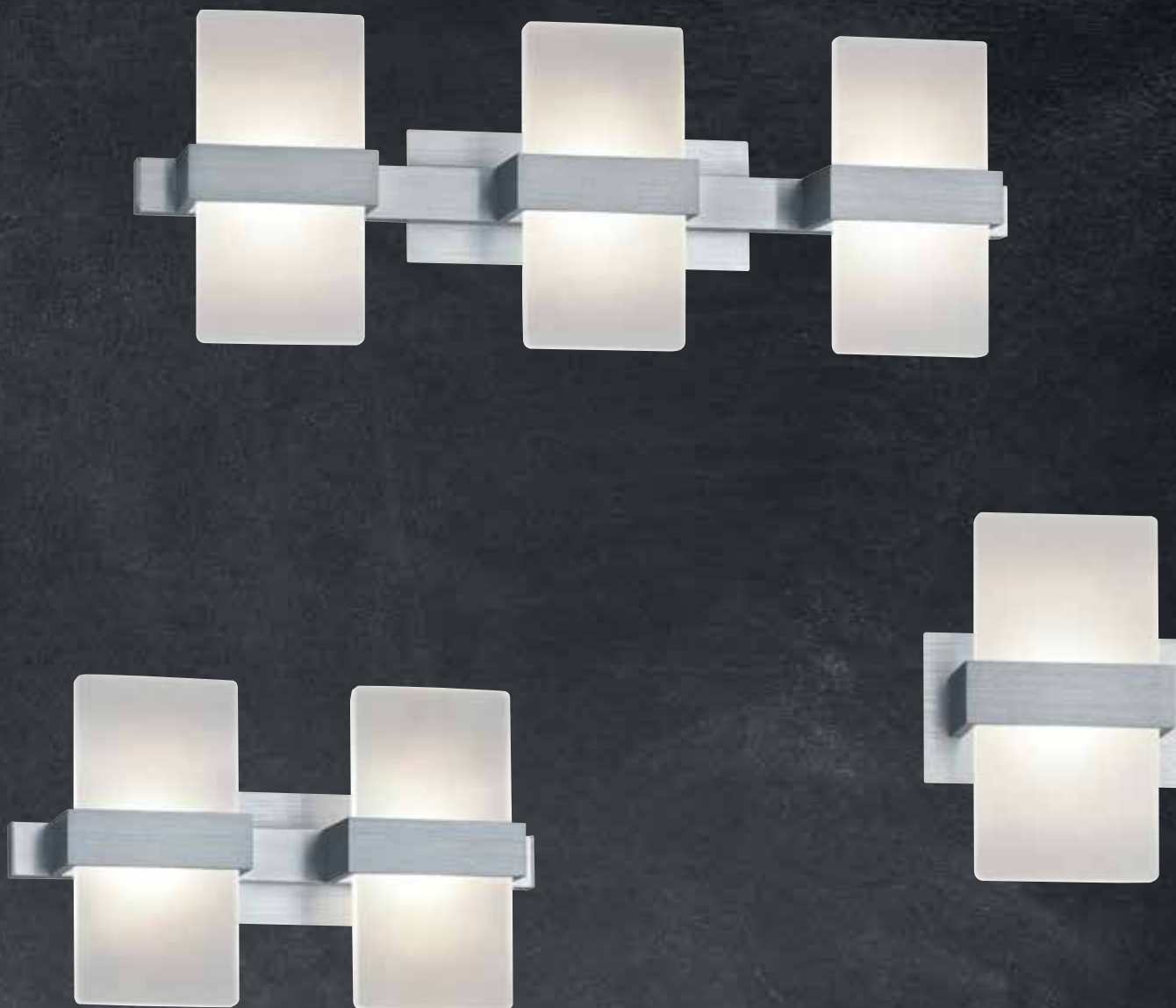

## PLATON

Aluminium gebürstet, Acryl · brushed aluminium, acryl · aluminium balayé, acryl · geborsteld aluminium, acryl · aluminio pulido, acrílico · alluminio spazzolato, acrilico · aluminiu lucios, acrilic · harjattu alumiini, akryyli · aluminium szczotkowane, akryl · alüminyum, akrilik



↔ 13 x 18 cm, √ 9 cm  
incl. 1 x SMD-LED, 4,5 W  
430 lm, 3.000 K



274670105



↔ 30 x 18 cm, √ 11 cm  
incl. 2 x SMD-LED, 4,5 W  
2 x 430 lm, 3.000 K



274670205



↔ 45 x 18 cm, √ 11 cm  
incl. 3 x SMD-LED, 4,5 W  
3 x 430 lm, 3.000 K



274670305



## CUADRO

altmessing, chrom oder Nickel matt · old brass, chrome or nickel mat ·  
 laiton fumé, chrome ou nickel mat · oud brons, chrom of nikkell mat ·  
 bronce viejo, cromo o níquel mate · ottone invecchiato, cromo o nichel opaco ·  
 bronz antic, crom sau nichel mat · antiikkimessinki, kromi tai harjattu teräs ·  
 patyna, chrom lub nikiel mat · antik piringç, krom veya mat nikel

372



↔ 48 x 10,5 cm, √ 10 cm  
 incl. 1 x SMD-LED, 8 W  
 600 lm, 3.000 K

A



225210104  
 225210106  
 225210107

**04** altmessing · old brass  
**06** chrom · chrome  
**07** Nickel matt · nickel mat

07



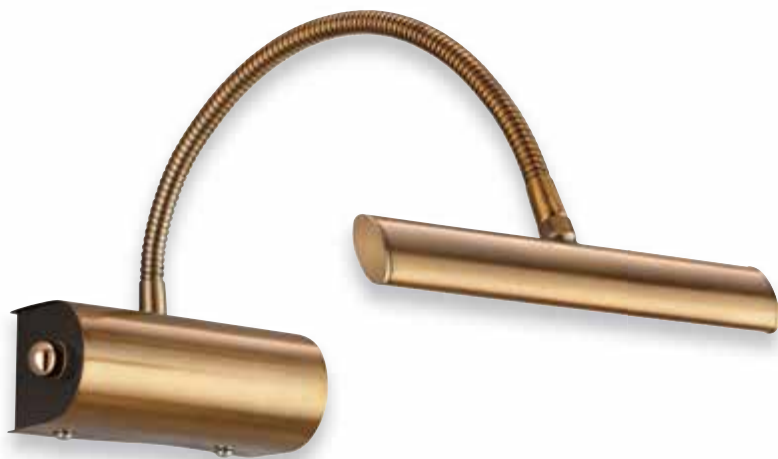

04



07

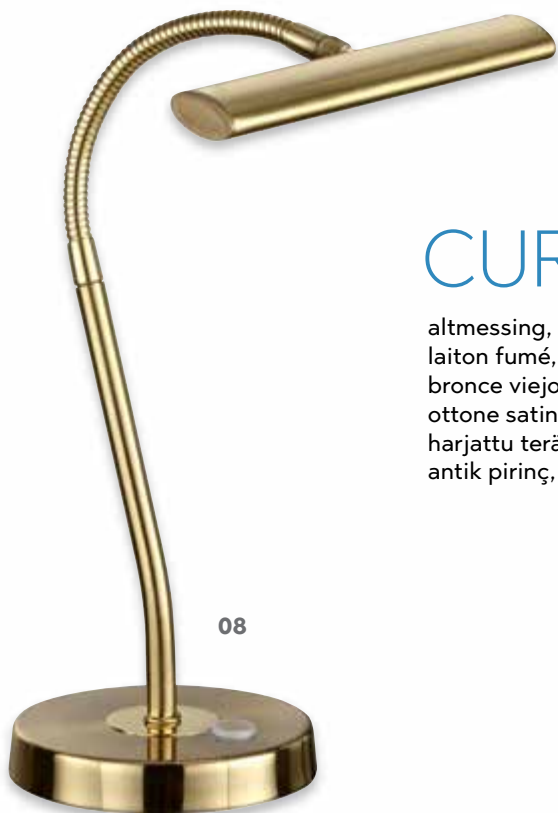

08

## CURTIS

altmessing, Nickel matt oder Messing matt · old brass, nickel mat or brass mat ·  
 laiton fumé, nickel mat ou laiton mat · oud brons, nikkel mat of messing mat ·  
 bronze viejo, níquel mate o bronze mate · ottone invecchiato, nichel opaco o  
 ottone satinato · bronz antic, nichel mat sau bronz mat · antiikkimesinki,  
 harjattu teräs tai mattamessinki · patyna, nikiel mat lubmosiãdz mat ·  
 antik piriñ, mat nikel veya mat piriñ



↔ 18 cm, ↗ max. 35 cm  
 incl. SMD-LED, 4 W  
 380 lm, 3.000 K



279770104  
 279770107  
 279770108



↓ 35 cm, ↗ max. 18,5 cm  
 incl. SMD-LED, 4 W  
 380 lm, 3.000 K



579790104  
 579790107  
 579790108



04 altmessing · old brass  
 07 Nickel matt · nickel mat  
 08 Messing matt · brass mat







## MARLON

Nickel matt, Glas matt · nickel mat, mat glass ·  
 nickel mat, verre mat · nikkell mat, mat glas ·  
 níquel mate, vidrio mate · nichel opaco, vetro sabbiato ·  
 nichel mat, sticla mata · harjattu teräs, mattalasi ·  
 nikiel mat, szkło matowane · mat nikel, mat cam

376



↓ 11 x 8 cm, ↗ 16 cm  
 excl. 1 x G9, max. 28 W



8160211-07



↓ 32 x 8 cm, ↗ 20 cm  
 excl. 1 x G9, max. 28 W



8160911-07

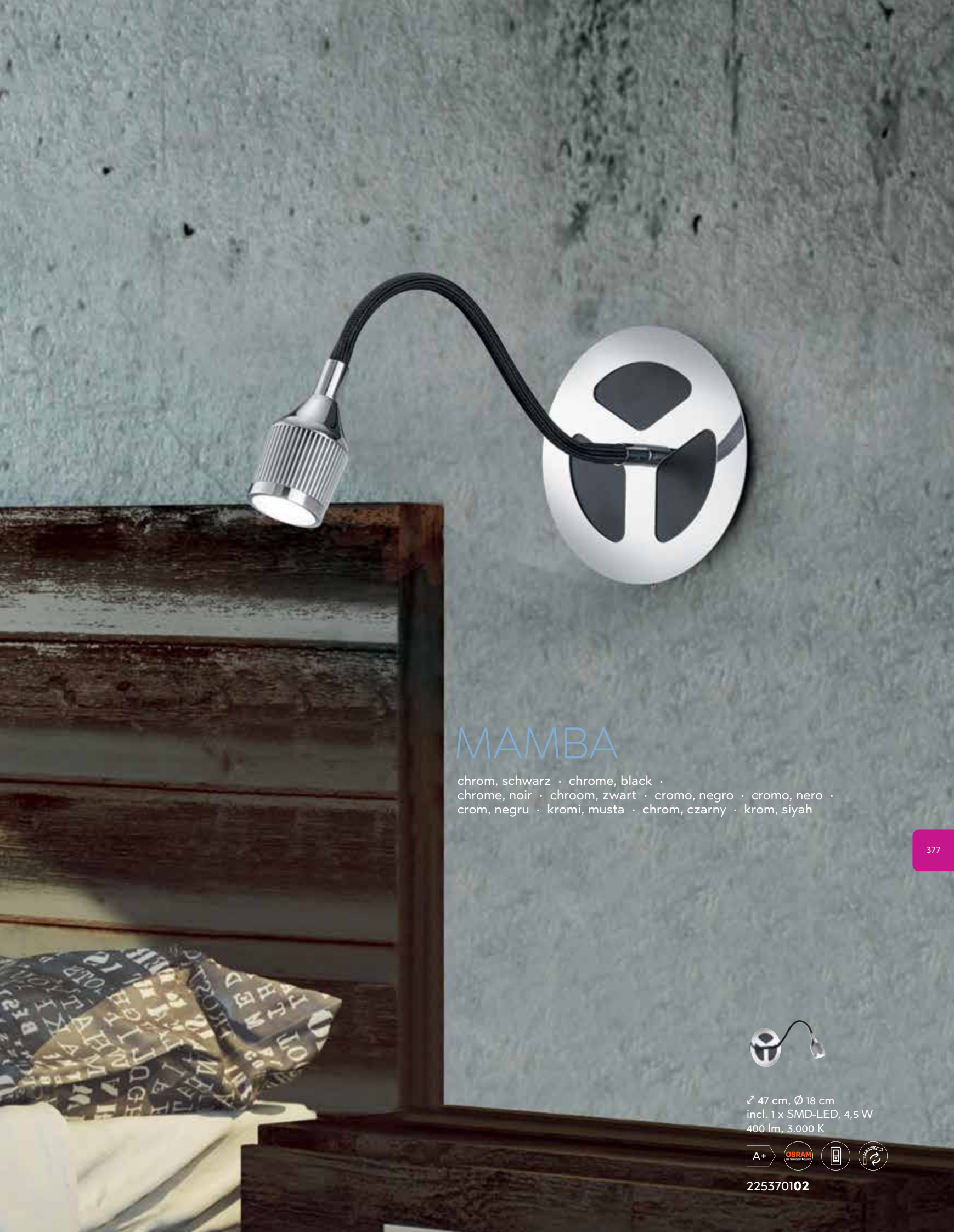

## MAMBA

chrom, schwarz · chrome, black ·  
chrome, noir · chroom, zwart · cromo, negro · cromo, nero ·  
crom, negru · kromi, musta · chrom, czarny · krom, siyah

377



∇ 47 cm, Ø 18 cm  
incl. 1 x SMD-LED, 4,5 W  
400 lm, 3.000 K



225370102



## CAMPO

rostfarbig, Scavo glas · rusty, scavo glass ·  
rouille, verre scavo · roestkleur, scavo glas ·  
óxido, vidrio scavo · ruggine, vetro scavo ·  
ruginiu, sticla scavo · rustiikki, scavo-lasi ·  
miedź, szkło scavo · pas, scavo cam

## FACELLA

Nickel matt oder rostfarbig, Glas alabasterfarbig ·  
nickel mat or rusty, alabaster-coloured glass ·  
nickel mat ou rouille, verre couleur albâtre ·  
nikkel mat of roestkleur, albastkleurig glas ·  
níquel mate o óxido, vidrio de color alabastro ·  
nichel opaco o ruggine, vetro colore alabastro ·  
nichel mat sau ruginiu, sticla culoare alabastru ·  
harjattu teräs tai rustiikki, lasi alabasteri väri ·  
nikiel mat lub miedź, szkło alabaster kolor ·  
mat nikel veya pas, cam kaymaktaşı rengi



## CONO

Nickel matt oder rostfarbig, Glas · nickel mat or rusty, glass ·  
nickel mat ou rouille, verre · nikkell mat of roestkleur, glas ·  
níquel mate o óxido, vidrio · nichel opaco o ruggine, vetro ·  
nichel mat sau ruginiu, sticla · harjattu teräs tai rustiikki, lasi ·  
nikiel mat lub miedź, szkło · mat nikel veya pas, cam



↓ 44 cm, ↔ 12 cm, ↗ 16 cm  
excl. 1 x E14, max. 40 W

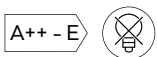

200970124



↓ 35 cm, ↔ 10 cm, ↗ 15 cm  
excl. 1 x E14, max. 60 W



2502211-07



↓ 27 cm, ↔ 5,5 cm, ↗ 10 cm  
excl. 1 x G9, max. 28 W



216070107  
216070124



07 Nickel matt · nickel mat  
24 rostfarbig · rusty



## TORCIA

rostfarbig, Scavo glas · rusty, scavo glass ·  
rouille, verre scavo · roestkleur, scavo glas · óxido, vidrio scavo ·  
ruggine, vetro scavo · ruginiu, sticla scavo · rustiikki, scavo-lasi ·  
miedz, szkło scavo · pas, scavo cam

379



↑ 80 cm, ↔ 15 cm, ↗ 18,2 cm  
excl. 1 x E14, max. 60 W

A++ - E



2529211-24



## VITA

Glas alabasterfarbig · alabaster-coloured glass ·  
verre couleur albâtre · albastkleurig glas · vidrio de color alabastro ·  
vetro colore alabastro · sticla culoare alabastru · lasi alabasteri väri ·  
szkło alabaster kolor · cam kaymaktaşı rengi

## MIRO

Glas matt · mat glass ·  
verre mat · mat glas · vidrio mate · vetro sabbiato ·  
sticla mata · mattalasi · szkło matowane · mat cam



↓ 40 cm, ↔ 18,5 cm, ↗ 9,5 cm  
excl. 2 x E14, max. 40 W

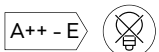

2501021-01



↓ 29 cm, ↔ 20 cm, ↗ 11 cm  
excl. 1 x E27, max. 60 W

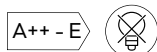

2524011-07



## OLIVIA

Nickel matt, Glas matt · nickel mat, mat glass ·  
 nickel mat, verre mat · nikkell mat, mat glas ·  
 níquel mate, vidrio mate · nichel opaco, vetro sabbiato ·  
 nichel mat, sticla mata · harjattu teräs, mattalasi ·  
 nikiel mat, szkło matowane · mat nikel, mat cam



## DIVO

chrom, Glas · chrome, glass ·  
 chrome, verre · chroom, glas · cromo, vidrio ·  
 cromo, vetro · crom, sticla · kromi, lasi ·  
 chrom, szkło · krom, cam



## MARTA

chrom, Glas · chrome, glass ·  
 chrome, verre · chroom, glas · cromo, vidrio ·  
 cromo, vetro · crom, sticla · kromi, lasi ·  
 chrom, szkło · krom, cam



↔ 10 cm, ↓ 38 cm, ↗ 9 cm  
 incl. 1 x G9, 28 W  
 370 lm, 2.800 K



210710107



↔ 20 x 20 cm, ↗ 8 cm  
 excl. 1 x E14, max. 40 W

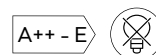

2522011-06



↔ 20 x 20 cm, ↗ 8 cm  
 excl. 1 x E14, max. 40 W

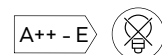

2523011-01



## LAON

Nickel matt · nickel mat ·  
nickel mat · nikkel mat ·  
níquel mate · nichel opaco ·  
nichel mat · harjattu teräs ·  
nikiel mat · mat nikel

**LED SWITCHDIMMER**



## FRED

Glas matt · mat glass ·  
verre mat · mat glas ·  
vidrio mate · vetro sabbiato ·  
sticla mata · mattalasi ·  
szkło matowane · mat cam

**LED SWITCHDIMMER**



## LIGARA

Kunststoff · plastic ·  
plastique · kunststof ·  
plástico · plastica · plastic ·  
muovi · plastik · plastik



↓ 40 cm, ↗ max. 20 cm  
incl. 1 x LED G9, 3 W  
320 lm, 3.000 K



891770107



↓ 40 cm, ↗ max. 16 cm  
incl. 1 x LED GU10, 5 W  
400 lm, 3.000 K



899670107



↓ 28 cm, ↗ max. 20 cm  
excl. 1 x E14, max. 40 W



8911211-07



# LEVISTO

Glas alabasterfarbig · alabaster-coloured glass ·  
verre couleur albâtre · albastkleurig glas · vidrio de color alabastro ·  
vetro colore alabastro · sticla culoare alabastru · lasi alabasteri väri ·  
szkło alabaster kolor · cam kaymaktaşı rengi

**LED SWITCHDIMMER**



383

↑ 40 cm, √ max. 22 cm  
incl. 1 x LED E14, 6 W  
470 lm, 3.000 K



891010107

# SIMEO

Kunststoff, weiß · plastic, white ·  
plastique, blanc · kunststof, wit · plástico, blanco ·  
plastica, bianco · plastic, alb · muovi, valkoinen ·  
plastik, biały · plastik, beyaz





Gestensteuerung · Gesture control ·  
Contrôle gestuel · Gebaarbediening ·  
Control gestual · Controllo gestuale ·  
Control prin gesturi/miscarea mainii ·  
Kädellä ohjattava liiketunnistin ·  
Sterowana gestami · Jest Kontrol

385



↔ 52,8 x 6,8 cm, ↑ 1,8 cm  
incl. SMD-LED, 10 W  
850 lm, 3.000 K



273271201



↔ 77 x 6,8 cm, ↑ 1,8 cm  
incl. SMD-LED, 15,5 W  
1.300 lm, 3.000 K



273271801





## ARAGON

Kunststoff, weiß oder titanfarbig · plastic, white or titan ·  
 plastique, blanc ou titane · kunststof, wit of titaan · plástico, blanco o titán ·  
 plastica, bianco o titano · plastic, alb sau titaniu · muovi, valkoinen tai titaani ·  
 plastik, biały lub tytanowy · plastik, beyaz veya titan



## ALINO

Kunststoff, weiß oder titanfarbig · plastic, white or titan ·  
 plastique, blanc ou titane · kunststof, wit of titaan · plástico, blanco o titán ·  
 plastica, bianco o titano · plastic, alb sau titaniu · muovi, valkoinen tai titaani ·  
 plastik, biały lub tytanowy · plastik, beyaz veya titan



↔ 40 x 4 cm, ↓ 2 cm  
 incl. 3 x SMD-LED, 1 W  
 3 x 80 lm, 3.000 K

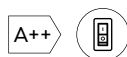

**273170301**  
**273170387**

↔ 55 x 4 cm, ↓ 2 cm  
 incl. 4 x SMD-LED, 1 W  
 4 x 80 lm, 3.000 K

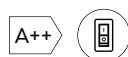

**273170401**  
**273170487**

↔ 34 x 7 cm, ↓ 2 cm  
 incl. SMD-LED, 4 W  
 350 lm, 3.000 K



**272970401**  
**272970487**

↔ 55 x 7 cm, ↓ 2 cm  
 incl. SMD-LED, 7 W  
 600 lm, 3.000 K

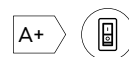

**272970701**  
**272970787**



**01** weiß · white  
**87** titanfarbig · titanium-coloured



388

## RAMON

Kunststoff · plastic ·  
 plastique · kunststof · plástico · plastica ·  
 plastic · muovi · plastik · plastik

↔ 28 x 2,5 cm, ↑ 4 cm  
 incl. 1 x SMD-LED, 4 W  
 350 lm, 3.000 K



273070401

↔ 51 x 2,5 cm, ↑ 4 cm  
 incl. 1 x SMD-LED, 7 W  
 600 lm, 3.000 K



273070701

↔ 84 x 2,5 cm, ↑ 4 cm  
 incl. 1 x SMD-LED, 13 W  
 1.100 lm, 3.000 K



273071301

↔ 114 x 2,5 cm, ↑ 4 cm  
 incl. 1 x SMD-LED, 18 W  
 1.500 lm, 3.000 K



273071801



## ECCO

Nickel matt · nickel mat ·  
nickel mat · nikkell mat · níquel mate · nichel opaco ·  
nichel mat · harjattu teräs · nikiel mat · mat nikel

389



↔ 13 x 13 cm, ↑ 4 cm  
incl. 3 x SMD-LED, 3 W  
3 x 200 lm, 3.000 K



273370307 Set: 3 St./3 pc.







## Pendelleuchten & Kronen

Pendants & chandeliers  
Lustres & suspensions  
Hanglampen & kroonluchters  
Colgantes y Lámparas  
Lampadari e sospensioni  
Lustre si pendule  
Riippu- & kruunu  
Wiszące i żyrandole  
Avize & Sarkıtlar

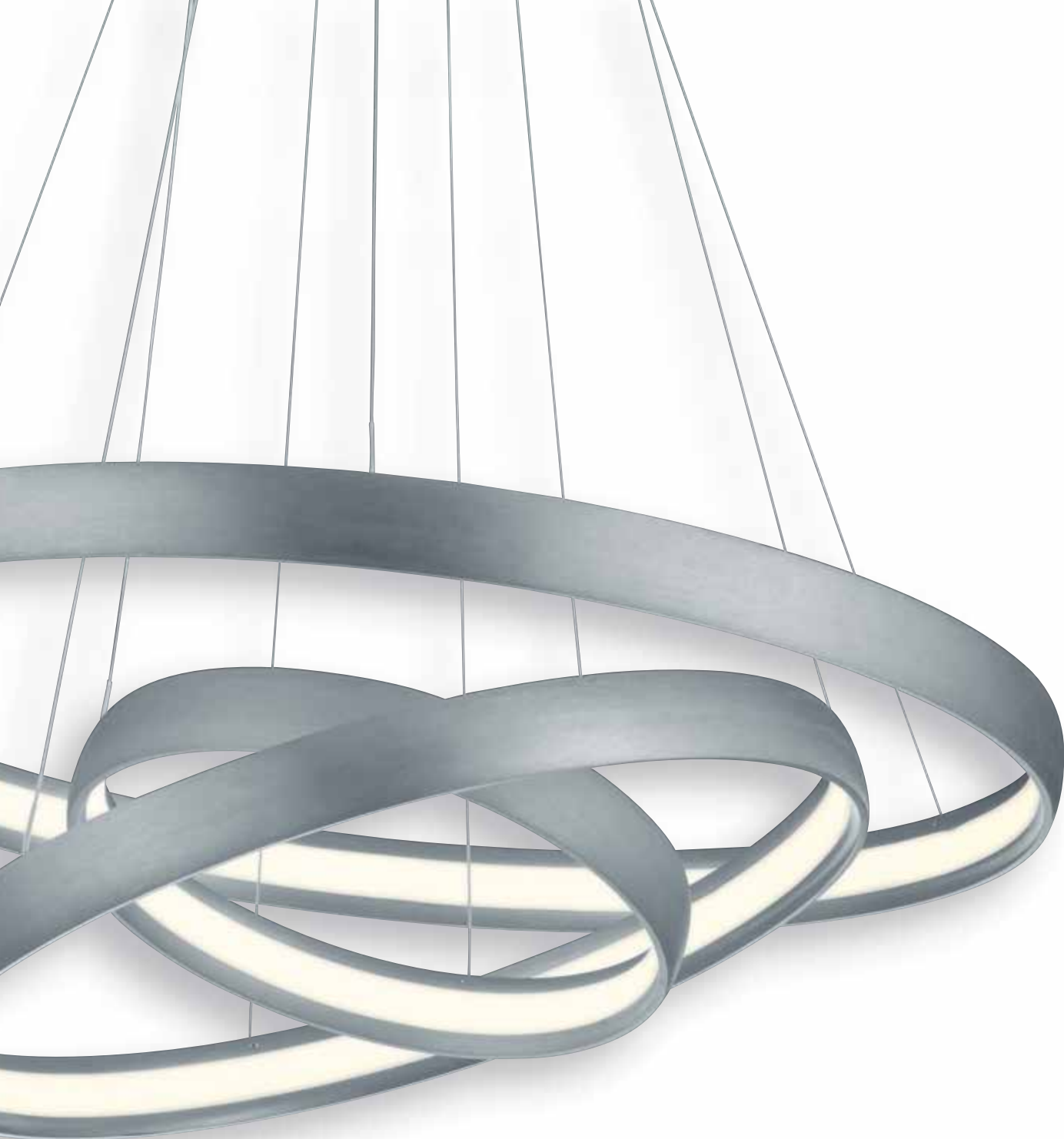

392

## MACAU

Aluminium gebürstet · brushed aluminium ·  
aluminium balayé · geborsteld aluminium · aluminio pulido ·  
alluminio spazzolato · aluminiu lucios · harjattu alumiini ·  
aluminium szczotkowane · alüminyum

**LED SWITCHDIMMER**



Ø 75 cm, ↑ max. 200 cm  
incl. SMD-LED, 64 W  
6.000 lm, 3.000 K



325610305





## SALINERO

Aluminium gebürstet, Acryl · brushed aluminium, acryl ·  
aluminium balayé, acryl · geborsteld aluminium, acryl ·  
aluminio pulido, acrílico · alluminio spazzolato, acrilico ·  
aluminu lucios, acrilic · harjattu alumiini, akryyli ·  
aluminium szczotkowane, akryl · alüminyum, akrilik



4 fach Touch  
4 level touch



↔ 115 x 2 cm, ↑ 90 - 150 cm  
incl. SMD-LED, 30 W  
2.800 lm, 3.000 K



377590205



## SATURN

chrom, Acryl · chrome, acryl ·  
chrome, acryl · chroom, acryl · cromo, acrílico ·  
cromo, acrílico · crom, acrílic · kromi, akryyli ·  
chrom, akryl · krom, akrilik

395



↑ 130 cm, Ø 50 cm  
incl. SMD-LED, 36 W  
3.500 lm, 3.000 K



376013606

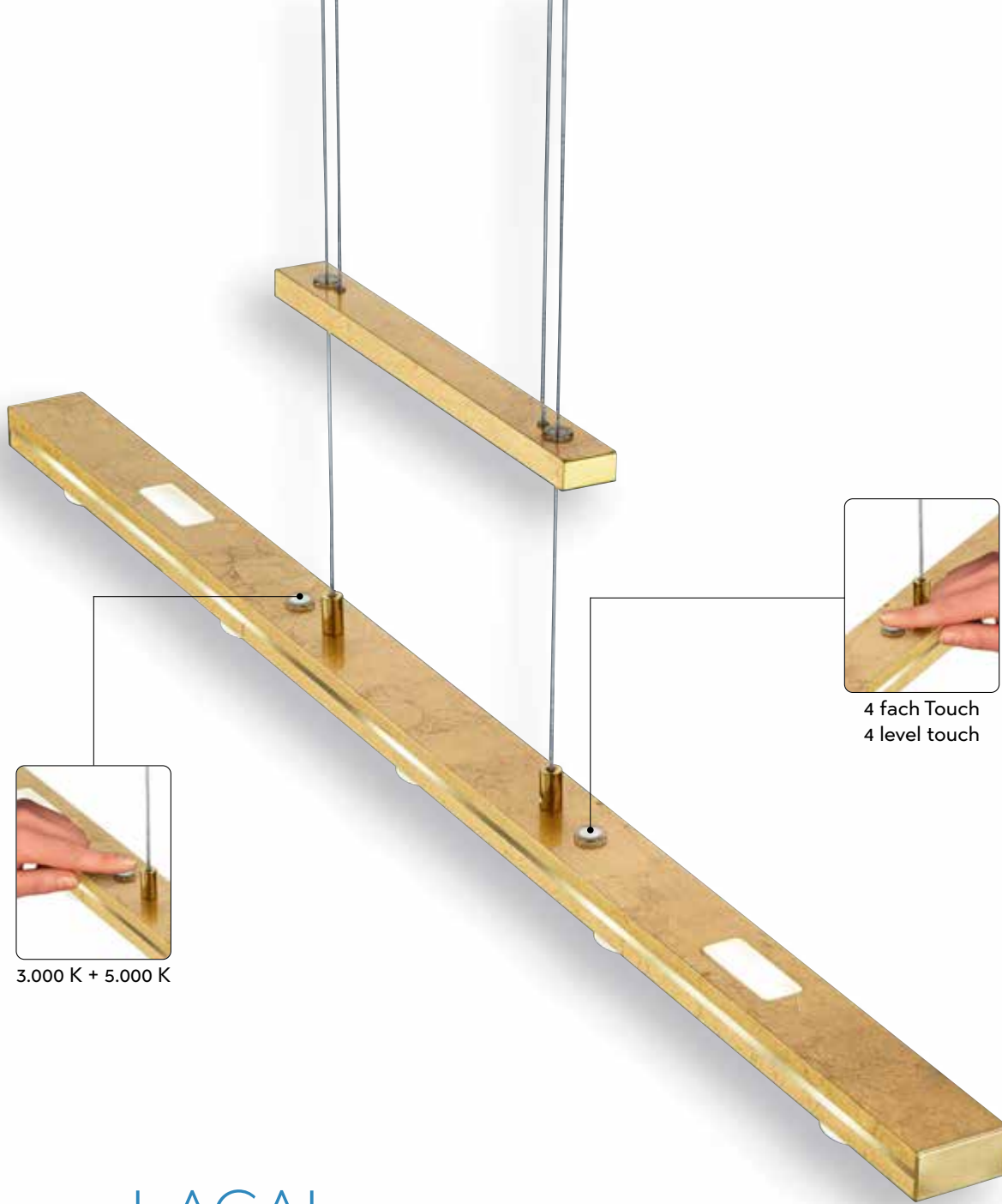

3.000 K + 5.000 K

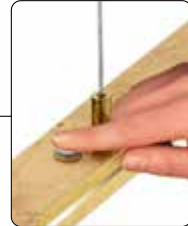

4 fach Touch  
4 level touch

## LACAL

Nickel matt oder goldfarbig · nickel mat or gold ·  
nickel mat ou or · nikkell mat of goud · níquel mate o oro · nichel opaco o oro ·  
nichel mat sau aur · harjattu teräs tai kultaa · nikiel mat lub złota · mat nikel veya altın

Gibt Licht nach oben und unten · up and down lighting ·  
point lumineux en haut et en bas · lichtpunt boven en onder ·  
luz de arriba y abajo · luce su e giù · sus și în jos lumina ·  
ylös ja alas valoa · w górę iw dół światło · yukarı ve aşağı ışık



↔ 100 cm, ↑ 95 - 160 cm  
incl. 7 x SMD-LED, 3,5 W  
7 x 350 lm, 3.000 + 5.000 K



379190707  
379190779



**07** Nickel matt · nickel mat  
**79** goldfarbig · gold



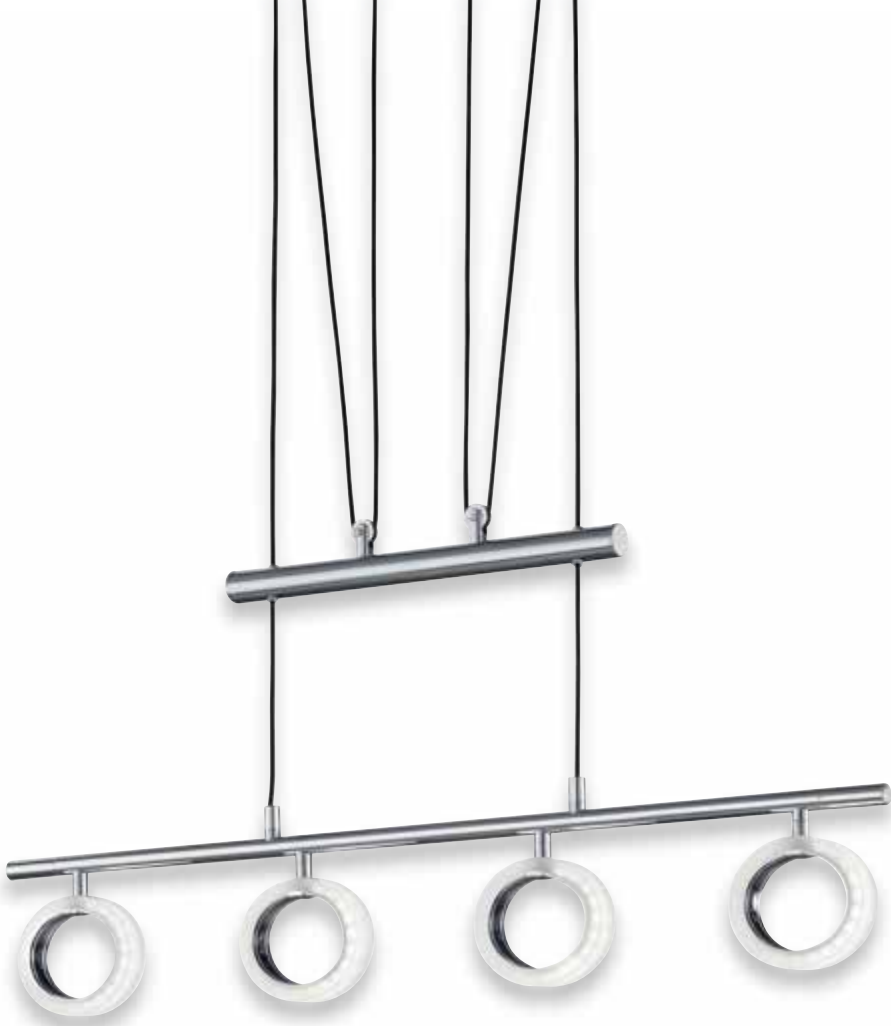

## CORLAND II

chrom, Acryl · chrome, acryl ·  
 chrome, acryl · chroom, acryl · cromo, acrílico ·  
 cromo, acrilico · crom, acrilic · kromi, akryyli ·  
 chrom, akryl · krom, akrilik

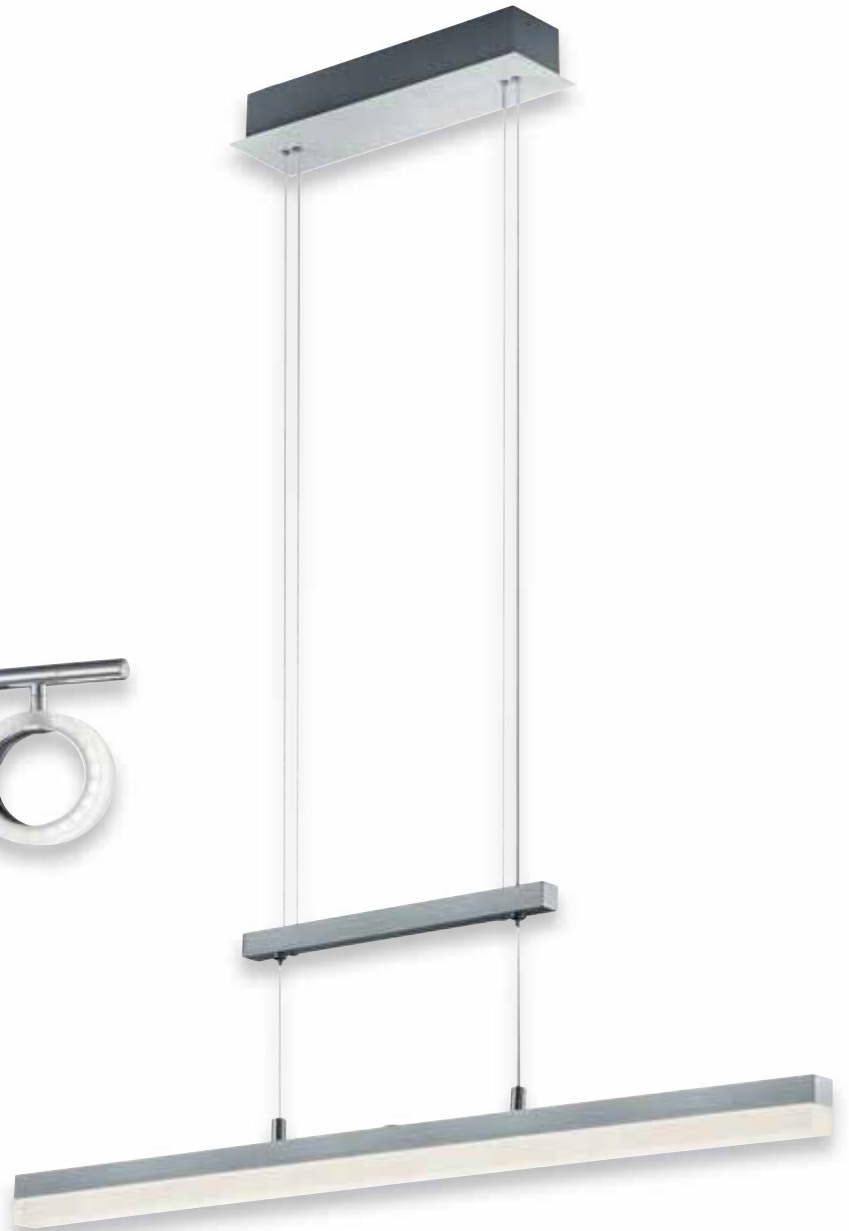

## CALVARO

Aluminium gebürstet, Acryl · brushed aluminium, acryl ·  
 aluminium balayé, acryl · geborsteld aluminium, acryl ·  
 aluminio pulido, acrílico · alluminio spazzolato, acrilico ·  
 aluminiu lucios, acrilic · harjattu alumiini, akryyli ·  
 aluminium szczotkowane, akryl · alüminyum, akrilik



4 fach Touch  
 4 level touch



↔ 80 cm, ↑ 85 - 170 cm  
 incl. 4 x SMD-LED, 3,5 W  
 4 x 370 lm, 3.000 K



374210406



↔ 80 x 2,5 cm, ↑ 90 - 150 cm  
 incl. SMD-LED, 20 W  
 1.900 lm, 3.000 K



377690105



# STAKKATO

Nickel matt, Glas satiniert ·  
nickel mat, satinated glass ·  
nickel mat, verre satiné ·  
nikkel mat, gesatineerd glas ·  
níquel mate, vidrio satinado ·  
nichel opaco, vetro satinato ·  
nichel mat, sticla satinata ·  
harjattu teräs, satinoitu lasi ·  
nikiel mat, szkło satynowe ·  
mat nikel, satin cam



399



↔ 87 x 10 cm, ↓ 95 - 150 cm  
incl. 3 x SMD-LED, 4,5 W  
3 x 430 lm, 3.000 K



377310307



## DROPS

Aluminium gebürstet, Acryl · brushed aluminium, acryl · aluminium balayé, acryl · geborsteld aluminium, acryl · aluminio pulido, acrílico · alluminio spazzolato, acrilico · aluminiu lucios, acrilic · harjattu alumiini, akryyli · aluminium szczotkowane, akryl · alüminyum, akrilik

400

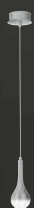

↑ 130 cm, Ø 12 cm  
incl. 1 x COB-LED, 4,5 W  
1 x 350 lm, 3.000 K

A+

327910105

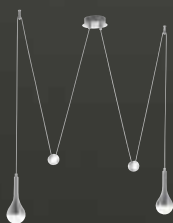

↔ max. 150 cm, ↑ 80 - 150 cm  
incl. 2 x COB-LED, 4,5 W  
2 x 350 lm, 3.000 K

A+



327910205



## CAVALLO

Aluminium gebürstet · brushed aluminium ·  
aluminium balayé · geborsteld aluminium · aluminio pulido ·  
alluminio spazzolato · aluminiu lucios · harjattu alumiini ·  
aluminium szczotkowane · alüminyum



4 fach Touch  
4 level touch



↔ 100 x 5 cm, ↓ 95 - 160 cm  
incl. 5 x SMD-LED, 4,5 W  
5 x 430 lm, 3.000 K



379090505



# ROMULUS

Metall, Acryl · metal, acryl ·  
 metale, acryl · metaal, acryl · metal, acrílico · metallo, acrilico ·  
 metal, acrilic · metalli, akryyli · metal, akryl · metal, akrilik

## LED SWITCHDIMMER



↔ 70 - 100 cm, ↑ 7,5 cm, √ 11,5 cm  
 incl. SMD-LED, 26 W  
 3.000 lm, 3.000 K



**673710207**  
**673710231**  
**673710232**



↔ 70 - 100 cm, ↑ 150 cm, √ 11,5 cm  
 incl. SMD-LED, 26 W  
 3.000 lm, 3.000 K



**373710207**  
**373710231**  
**373710232**



↔ 100 - 150 cm, ↑ 150 cm, √ 11,5 cm  
 incl. SMD-LED, 37 W  
 4.500 lm, 3.000 K



**373790207**  
**373790231**  
**373790232**



**07** Nickel matt · nickel mat  
**31** weiß matt · white mat  
**32** schwarz matt · black mat





## REMUS

Metall, Acryl · metal, acryl ·  
 metale, acryl · metaal, acryl · metal, acrílico · metallo, acrilico ·  
 metal, acrylic · metalli, akryyli · metal, akryl · metal, akrilik

**LED SWITCHDIMMER**



↔ 95 x 14 cm, ↑ 150 cm  
 incl. SMD-LED, 38 W  
 4.200 lm, 3.000 K



**374810107**  
**374810131**  
**374810132**



**07** Nickel matt · nickel mat  
**31** weiß matt · white mat  
**32** schwarz matt · black mat





## SENATOR

Nickel matt oder Messing matt, Glas matt · nickel mat or brass mat, mat glass ·  
 nickel mat ou laiton mat, verre mat · nikkell mat of messing mat, mat glas ·  
 níquel mate o bronze mate, vidrio mate · nichel opaco o ottone satinato, vetro sabbaiato ·  
 nichel mat sau bronz mat, sticla mata · harjattu teräs tai mattamessinki, mattalasi ·  
 nikiel mat lub mosiądz mat, szkło matowane · mat nikel veyá mat piringç, mat cam



4 fach Touch  
4 level touch



↔ 90 x 8 cm, ↓ 95 - 160 cm  
 incl. 4 x SMD-LED, 4,5 W  
 4 x 430 lm, 3.000 K



324390407  
324390408

**07** Nickel matt · nickel mat  
**08** Messing matt · matt brass



# MONTREAL

rostfarbig antik · antique rust ·  
rouille antique · roestkleur antiek · oxido · ruggine anticato ·  
ruginiu antic · rustiikki · antyczny rdzawy · antik pas rengi



4 fach Touch  
4 level touch



↔ 100 x 10 cm, ↑ 150 cm  
incl. 5 x SMD-LED, 4,5 W  
5 x 430 lm, 3.000 K

A+



376790528



## ROMINO II

schwarz matt, Metall · black mat, metal ·  
noir mat, metale · mat zwart, metaal ·  
estera negra, metal · nero opaco, metallo ·  
negru mat, metal · musta matto, metalli ·  
czarny mat, metal · siyah mat, metal



## HOUSTON

schwarz matt, Metall · black mat, metal ·  
noir mat, metale · mat zwart, metaal ·  
estera negra, metal · nero opaco, metallo ·  
negru mat, metal · musta matto, metalli ·  
czarny mat, metal · siyah mat, metal



## EVA

Metall · metal ·  
metale · metaal · metal · metallo ·  
metal · metalli · metal · metal



408



Ø 50 cm, ↓ 150 cm  
excl. 1 x E27, max. 60 W

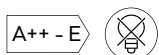

308000132



Ø 35 cm, ↓ 150 cm  
excl. 1 x E27, max. 60 W

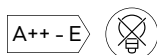

300300132



Ø 25 cm, ↓ 150 cm  
excl. 1 x E14, max. 40 W

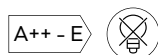

306400179



Ø 20,5 cm, ↓ 22,5 cm  
excl. 1 x E14, max. 40 W



506400179



## RAMIRO

schwarz matt, goldfarbig · black mat, gold ·  
noir mat, or · mat zwart, goud · estera negra, oro ·  
nero opaco, oro · negru mat, aur · musta matto, kultaa ·  
czarny mat, złota · siyah mat, altın



409

↔ 100 x 8,5 cm, ↓ 150 cm  
incl. 4 x SMD-LED, 4,5 W  
4 x 430 lm, 3.000 K

A+

OSRAM  
SMD-LED



376410402



## ONYX

Metall, anthrazit, innen goldfarbig · metal, anthracite, gold colored inside ·  
 metale, antracite, Or · metaal, antraciet, Binnenkant goudkleur ·  
 metal, antracita, Interior en color dorado · metallo, antracite, interno colore oro ·  
 metal, antracit, interior culoare aurie · metalli, antrasiitti, sisäosa kullanvärinen ·  
 metal, antracyt, wewnątrz złoty · metal, antrasit, altın iç kaplama



Ø 15 cm, ↓ 150 cm  
 excl. 1 x E27, max. 42 W

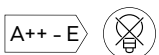

301300142



Ø 35 cm, ↓ 150 cm  
 excl. 3 x E27, max. 42 W

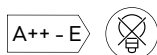

301300342



↔ 90 cm, ↓ 150 cm  
 excl. 4 x E27, max. 42 W

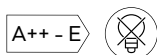

301300442



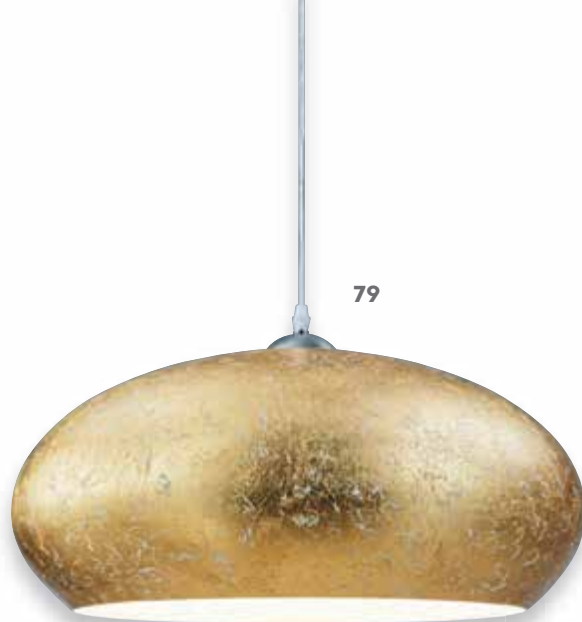

# OTTAWA

Metall · metal ·  
metale · metaal · metal · metallo ·  
metal · metalli · metal · metal



Ø 50 cm, ↓ 150 cm  
excl. 1 x E27, max. 60 W

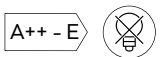

305700109  
305700179  
305700189

**09** kupferfarbig · copper  
**79** goldfarbig · gold  
**89** silberfarbig · silver

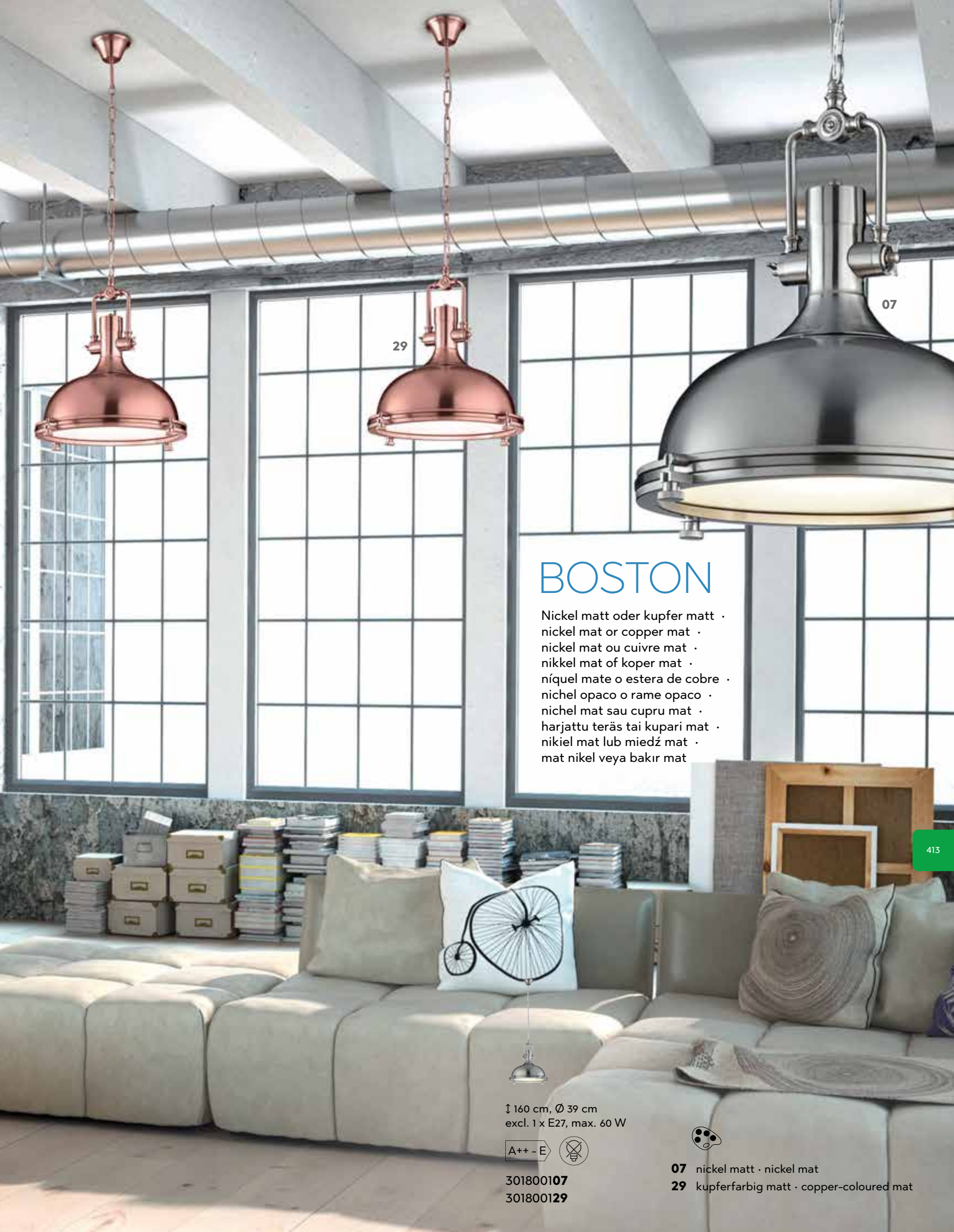

29

07

# BOSTON

Nickel matt oder kupfer matt ·  
 nickel mat or copper mat ·  
 nickel mat ou cuivre mat ·  
 nikkell mat of koper mat ·  
 níquel mate o estera de cobre ·  
 nichel opaco o rame opaco ·  
 nichel mat sau cupru mat ·  
 harjattu teräs tai kupari mat ·  
 nikiel mat lub miedz mat ·  
 mat nikel veya bakir mat

413

↑ 160 cm, Ø 39 cm  
 excl. 1 x E27, max. 60 W



301800107  
 301800129



**07** nickel matt · nickel mat  
**29** kupferfarbig matt · copper-coloured mat



# LISBOA

Metall, Glas weiß matt · metal, glass white mat ·  
 metale, verre blanc mat · metaal, glas wit mat · metal, vidrio estera blanca ·  
 metallo, vetro bianco opaco · metal, sticla alb mat · metalli, lasi valkoinen matto ·  
 metal, szkło biały mat · metal, cam beyaz mat



Ø 60 cm, ↑ 150 cm  
 excl. 3 x E27, max. 40 W

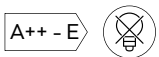

307700307  
 307700331  
 307700378

**07** Nickel matt · nickel mat  
**31** weiß matt · white mat  
**78** betonfarbig · concrete look





78



## RODDIK

Polyresin, betonfarbig · polyresin, concrete look ·  
 polyresin, couleur beton · polyresin, beton kleur ·  
 poliresina, color concreto · poliestere, calcestruzzo ·  
 polirasina, culoare beton · polyresiini, konkreettisia väri ·  
 polyresin, konkretny kolor · polirezin, beton rengi

416



Ø 16 cm, ↑ 150 cm  
 excl. 1 x E14, max. 40 W

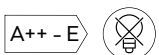

301100178



↔ 80 cm, ↓ 150 cm  
 excl. 3 x E14, max. 40 W

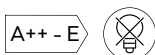

301100378



Ø 27,5 cm, ↓ max. 150 cm  
 excl. 1 x E27, max. 60 W

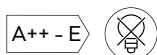

301190178





32

## BARON

Metall, Acryl · metal, acryl ·  
metale, acryl · metaal, acryl · metal, acrílico · metallo, acrilico ·  
metal, acrilic · metalli, akryyli · metal, akryl · metal, akrilik

418



Ø 52 cm, ↑ 150 cm  
excl. 4 x E27, max. 40 W

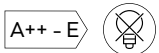

309800431  
309800432



**31** weiß matt · white mat  
**32** schwarz matt · black mat





31



05



01



## KANNAN

Aluminium gebürstet oder weiß · brushed aluminium or white · aluminium balayé ou blanc · geborsteld aluminium of wit · aluminio pulido o blanco · alluminio spazzolato o bianco · aluminiu lucios sau alb · harjattu alumiini tai valkoinen · aluminium szczotkowane lub biały · alüminyum veya beyaz

## SLASH

Aluminium gebürstet · brushed aluminium · aluminium balayé · geborsteld aluminium · aluminio pulido · alluminio spazzolato · aluminiu lucios · harjattu alumiini · aluminium szczotkowane · alüminyum



Ø 20 cm, ↓ 130 cm  
excl. 1 x E27, max. 28 W

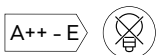

306200101  
306200105



Ø 36 cm, ↓ 138 cm  
excl. 1 x E27, max. 42 W

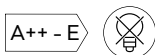

306300101  
306300105



Ø 30 cm, ↓ 135 cm  
excl. 1 x E27, max. 60 W

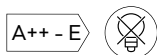

300203005



01 weiß · white

05 Aluminium gebürstet · brushed Aluminium



## NABAB

Aluminium gebürstet oder weiß · brushed aluminium or white ·  
aluminium balayé ou blanc · geborsteld aluminium of wit ·  
aluminio pulido o blanco · alluminio spazzolato o bianco ·  
aluminium lucios sau alb · harjattu alumiini tai valkoinen ·  
aluminium szczotkowane lub biały · alüminyum veya beyaz



## CALAIS

Glas amber oder Rauchglas · glass amber or smoked glass · verre ambre ou verre fumé · glas amber of rookglas · vidrio ámbar o vidrio ahumado · vetro ambra o vetro fume' · sticla amber sau sticla fumurie · lasi meripihka tai savulasi · szkło bursztynowy lub szkło przydymione · cam amber veyá puslu cam

422



↓ 130 cm, Ø 20 cm  
excl. 1 x E27, max. 60 W

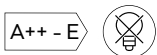

304800100  
304800142



↓ 130 cm, Ø 39,5 cm  
excl. 1 x E27, max. 60 W

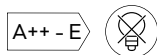

304900100  
304900142



00 natur · nature  
42 anthrazit · anthracite







00



42

## DOVER

Glas amber oder Rauchglas · glass amber or smoked glass ·  
verre ambre ou verre fumé · glas amber of rookglas ·  
vidrio ámbar o vidrio ahumado · vetro ambra o vetro fume' ·  
sticla amber sau sticla fumurie · lasi meripihka tai savulasi ·  
szkło bursztynowy lub szkło przydymione · cam amber veya puslu cam



26



30



424

## BOOLAN

Holz · wood ·  
bois · hout · madera · di legno ·  
lemn · puu · drewno · tahta

Empfohlen:  
recommended: Filament LED E27, 6 W  
420 lm, 2.700 K



A+

988-679



Ø 50 cm, ↑ 150 cm  
excl. 1 x E27, max. 60 W



305900126  
305900130

26 braun · brown  
30 holzfarbig hell · light colored wood



## BRONCO

Metall schwarz matt, goldfarbig · metal black mat, gold ·  
metale noir mat, or · metaal mat zwart, goud · metal estera negra, oro ·  
metallo nero opaco, oro · metal negru mat, aur · metalli musta matto, kultaa ·  
metal czarny mat, złota · metal siyah mat, altın



425



Ø 50 cm, ↑ 150 cm  
excl. 6 x E27, max. 40 W

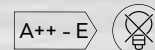

309200632



426



Ø 56 cm, ↑ 150 cm  
excl. 4 x E14, max. 40 W



102000403  
102000405



**03** Messing poliert · polished brass  
**05** Aluminium gebürstet · brushed aluminium



## CANDELA

Aluminium gebürstet/chrom oder Messing matt/Messing poliert · brushed aluminium/chrome or brass mat/polished brass · aluminium balayé/chrome ou laiton mat/laiton polis · geborsteld aluminium/chroom of messing mat/gepolijst messing · aluminio pulido/cromo o bronce mate/bronce · alluminio spazzolato/cromo o ottone satinato/ottone lucido · aluminiu lucios/crom sau bronz mat/bronz · harjattu alumiini/kromi tai mattamessinki/messinki · aluminium szczotkowane/chrom lub mosiądz mat/mosiądz polerowany · alüminyum/krom veya mat piringç/piringç



01



02

## CHIARA

chrom, Acryl · chrome, acryl ·  
chrome, acryl · chroom, acryl ·  
cromo, acrílico · cromo, acrilico ·  
crom, acrilic · kromi, akryyli ·  
chrom, akryl · krom, akrilik

428



Ø 50 cm, ↑ 150 cm  
excl. 5 x E14, max. 40 W

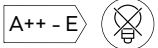

110400501  
110400502

01 weiß · white  
02 schwarz · black

# MINSK

Metall, Acryl · metal, acryl ·  
metale, acryl · metaal, acryl · metal, acrílico ·  
metallo, acrilico · metal, acrilic · metalli, akryyli ·  
metal, akryl · metal, akrilik



429



Ø 50 cm, ↓ max. 180 cm  
excl. 7 x E14, max. 28 W

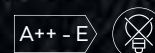

308600706



# CORTEZ

Metall, Stoffschilder · metal, fabric shade ·  
 metale, abat-jour tissu · metaal, Stoffen kap · metal, Pantalla de tela ·  
 metallo, paralume in tessuto · metal, abajur textil · metalli, kangas varjostin ·  
 metal, Klosz z materiału · metal, Kumaş şapka



Ø 47 cm, ↑ 150 cm  
 excl. 3 x E14, max. 40 W

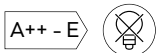

110600331  
 110600378



Ø 66 cm, ↑ 150 cm  
 excl. 5 x E14, max. 40 W

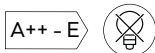

110600531  
 110600578



**31** weiß matt · white mat  
**78** betonfarbig · concrete look







## VICTORIA

chrom, Acryl · chrome, acryl ·  
chrome, acryl · chroom, acryl · cromo, acrílico ·  
cromo, acrilico · crom, acrilic · kromi, akryyli ·  
chrom, akryl · krom, akrilik

432



Ø 40 cm, ↑ 25 cm  
excl. 3 x E14, max. 40 W

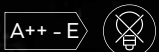

609700306



Ø 36 cm, ↑ 150 cm  
excl. 1 x E27, max. 60 W

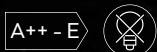

309700106



## EDISON II

chrom, Glas klar · chrome, clear glass ·  
chrome, verre claire · chroom, helder glas ·  
cromo, vidrio claro · cromo, vetro chiaro ·  
crom, sticlă transparentă · kromi, kirkas lasi ·  
chrom, przezroczyste szkło · krom, şeffaf

433



Ø 20 cm, ↓ 120 cm  
excl. 1 x E27, max. 40 W



340100106



Ø 28 cm, ↓ 130 cm  
excl. 1 x E27, max. 40 W

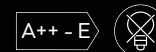

340190106

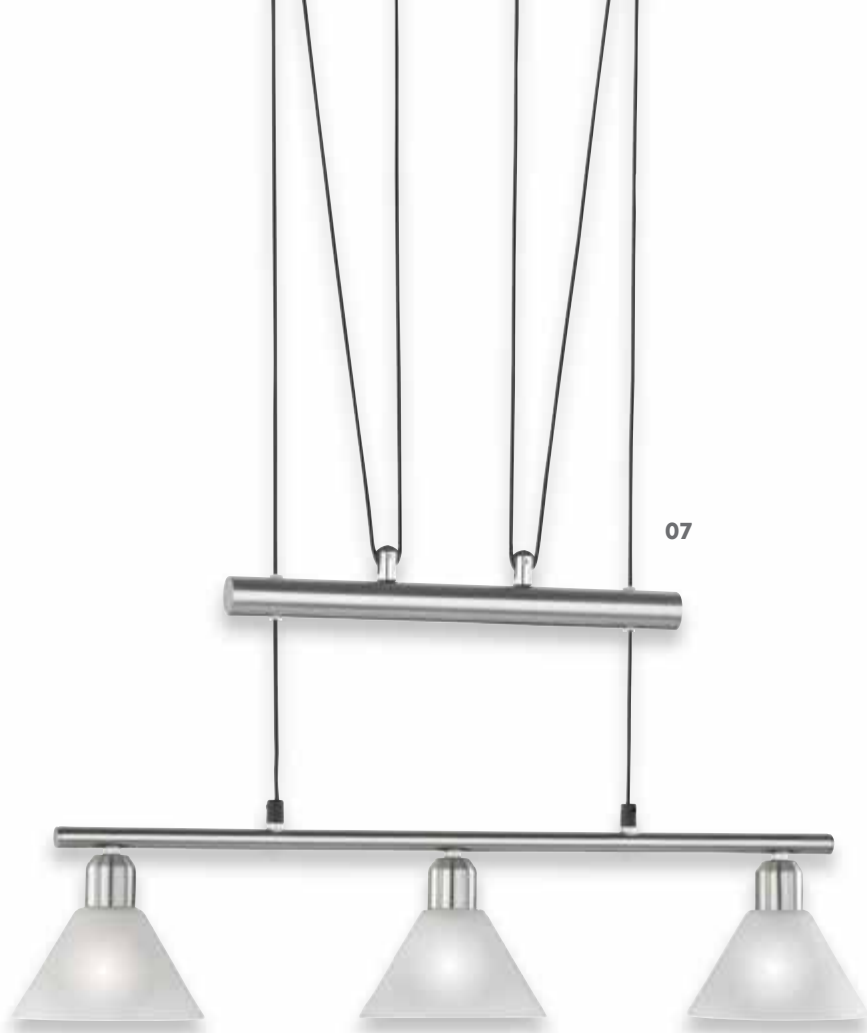

07



24



↔ 42 cm, ↑ 80 - 180 cm  
excl. 2 x E14, max. 40 W



3751021-07

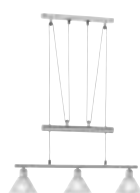

↔ 66 cm, ↑ 80 - 180 cm  
excl. 3 x E14, max. 40 W



3751031-07  
3751031-24



↔ 80 cm, ↑ 80 - 180 cm  
excl. 4 x E14, max. 40 W



3751041-07  
3751041-24



↔ 102 cm, ↑ 80 - 180 cm  
excl. 5 x E14, max. 40 W



3751051-07  
3751051-24



**07** Nickel matt · nickel mat  
**24** rostfarbig · rusty



## STAMINA

Nickel matt oder rostfarbig, Glas · nickel mat or rusty, glass ·  
nickel mat ou rouille, verre · nikkell mat of roestkleur, glas ·  
níquel mate o óxido, vidrio · nichel opaco o ruggine, vetro ·  
nichel mat sau ruginiu, sticla · harjattu teräs tai rustiikki, lasi ·  
nikiel mat lub miedź, szkło · mat nikel veyá pas, cam



## MONTENDER

Metall, Glas matt · metal, mat glass ·  
 metale, verre mat · metaal, mat glas · metal, vidrio mate ·  
 metallo, vetro sabbaiato · metal, sticla mata · metalli, mattalasi ·  
 metal, szkło matowane · metal, mat cam



Ø 40 cm, ↑ 150 cm  
 excl. 1 x E27, max. 60 W

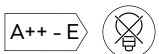

301900104  
 301900107  
 301900162



**04** altmessing · old brass  
**07** Nickel matt · nickel mat  
**62** kupfer antik · antique copper



## VIOLA

Glas alabasterfarbig · alabaster-coloured glass ·  
 verre couleur albâtre · albastkleurig glas ·  
 vidrio de color alabastro · vetro colore alabastro ·  
 sticla culoare alabastru · lasi alabasteri väri ·  
 szkło alabaster kolor · cam kaymaktaşı rengi



Ø 38,5 cm, ↑ 70 - 130 cm  
 excl. 1 x E27, max. 60 W



3017001**07**  
 3017001**08**



Ø 40 cm, ↑ 130 cm  
 excl. 1 x E27, max. 60 W

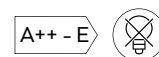

3407011-**07**



**07** Nickel matt · nickel mat  
**08** Messing matt · brass mat

## COLIN

Metall, Glas · metal, glass ·  
 metale, verre · metaal, glas · metal, vidrio ·  
 metallo, vetro · metal, sticla · metalli, lasi ·  
 metal, szkło · metal, cam



## LACAN

chrom, Acryl · chrome, acryl ·  
 chrome, acryl · chroom, acryl · cromo, acrílico ·  
 cromo, acrilico · crom, acrilic · kromi, akryyli ·  
 chrom, akryl · krom, akrilik



Ø 20 cm, ↑ 150 cm  
 excl. 1 x E27, max. 40 W

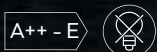

303900100



Ø 25 cm, ↑ 150 cm  
 excl. 1 x E27, max. 40 W



304200100



Ø 35 cm, ↑ 150 cm  
 excl. 1 x E27, max. 60 W



304290100





## BAJO

Metall weiß · metal white ·  
metale blanc · metaal wit · metal blanco · metallo bianco ·  
metal alb · metalli valkoinen · metal biały · metal beyaz

439



Ø 25 cm, ↓ 150 cm  
excl. 1 x E14, max. 40 W



307200101



Ø 35 cm, ↓ 150 cm  
excl. 1 x E27, max. 60 W

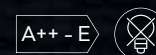

307290101



## DIEGO

Kunststoff, Glas · plastic, glass ·  
 plastique, verre · kunststof, glas · plástico, vidrio ·  
 plastica, vetro · plastic, sticla · muovi, lasi ·  
 plastik, szkło · plastik, cam

440



Ø 30 cm, ↑ 125 cm  
 excl. 1 x E27, max. 60 W

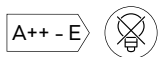

301400101  
 301400112  
 301400115  
 301400124



Ø 43 cm, ↑ 150 cm  
 excl. 1 x E27, max. 40 W

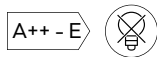

302400106



**01** weiß · white  
**06** chrom · chrome  
**12** blau · blue  
**15** grün · green  
**24** amber · amber

## CARBONADO

Dekorglas · glas decorated ·  
 verre décoré · decoratief glas · vidrio decorado ·  
 vetro decorato · sticla decorativa · ornamenttilasi ·  
 szkło dekoracyjne · dekoratif cam



92

00

06

# ZUCCA

chrom, Acryl · chrome, acryl ·  
 chrome, acryl · chroom, acryl · cromo, acrílico ·  
 cromo, acrilico · crom, acrylic · kromi, akryyli ·  
 chrom, akryl · krom, akrilik



Ø 40 cm, ↓ 150 cm  
 excl. 1 x E27, max. 60 W

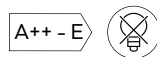

304100100  
 304100106  
 304100192



Ø 25 cm, ↓ 130 cm  
 excl. 1 x E27, max. 60 W

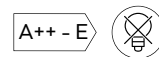

304000106



**00** transparent · transparent  
**06** chrom · chrome  
**92** purpurrot · purple



92

18

00

15

## PAPER

Papier · paper ·  
papier · papier · papel · carta ·  
hartie · paperi · papier · kağıt



↑ 73,5 cm  
excl. 1 x E27, max. 60 W  
VE / moq: 25

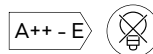

3590010-01

442



Ø 40 cm, ↑ 47 cm  
excl. 1 x E27, max. 60 W  
VE / moq: 25

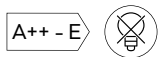

3491400-00



Ø 60 cm  
excl. 1 x E27, max. 60 W  
VE / moq: 25

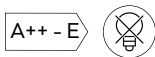

3490600-00



Ø 50 cm  
excl. 1 x E27, max. 60 W  
VE / moq: 25

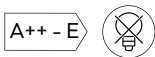

3490500-00



Ø 40 cm  
excl. 1 x E27, max. 60 W  
VE / moq: 25

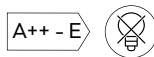

3490400-00  
3490400-15  
3490400-18  
3490400-19  
3490400-92



00 weiß · white  
15 grün · green  
18 orange · orange  
19 türkis · turquoise  
92 lila · lilac





# Steh- und Tischleuchten

Table- & floor lamps  
Lampes de table & lampadaires  
Tafel- & vloerlampen  
Sobremesas y lámparas de pie  
Lampade da tavolo e piantane  
Veioze si lampadare  
Pöytä- & lattia  
Stołowe i podłogowe  
Lambader & Masa lambaları





↓ 182 cm, Ø 31 cm, ∇ 60 cm  
 incl. 1 x SMD-LED, 36,4 W  
 3.640 lm, 2.700+3.350+4.000 K  
 incl. 1 x SMD, 7,3 W  
 730 lm, 2.700+3.350+4.000 K



**422910207**  
**422910208**



**07** Nickel matt · nickel mat  
**08** Messing matt · brass mat



2.700 K



3.350 K



4.000 K



# VARESE

Nickel matt oder Messing matt, Stoffschirm ·  
nickel mat or brass mat, fabric shade ·  
nickel mat ou laiton mat, abat-jour tissu ·  
nikkel mat of messing mat, Stoffen kap ·  
níquel mate o bronze mate, Pantalla de tela ·  
nichel opaco o ottone satinato, paralume in tessuto ·  
nichel mat sau bronz mat, abajur textil ·  
harjattu teräs tai mattamessinki, kangas varjostin ·  
nikiel mat lub mosiądz mat, Klosz z materiału ·  
mat nikel veya mat piring, Kumaş şapka



Sensordimmer · Sensor dimmer ·  
Variateur tactile · Touchdimmer ·  
Regulador con sensor · Touchdimmer ·  
Variator cu senzor · Kosketushimmennin ·  
Czujnik ściemniania · El dimeri





Getrennt schaltbar · Separately switchable  
Interrupteurs séparés · Gescheiden schakelbaar ·  
Interruptores separados · Interruttori separati ·  
Interrupatoare separate · Erikseen kytkettävissä ·  
Oddzieleny przełącznik · Dışarıdan anahtarlı



## CANNES II

chrom / Aluminium gebürstet, Acryl, Stoffschirm ·  
chrome / brushed aluminium, acryl, fabric shade ·  
chrome / aluminium balayé, acryl, abat-jour tissu · chrom / geborsteld aluminium, acryl,  
Stoffen kap · cromo / aluminio pulido, acrílico, Pantalla de tela · cromo / alluminio  
spazzolato, acrilico, paralume in tessuto · crom / aluminiu lucios, acrilic, abajur textil ·  
kromi / harjattu alumiini, akryyli, kangas varjostin · chrom / aluminium szczotkowane, akryl,  
Klosz z materiału · krom / alüminyum, akrilik, Kumaş şapka



↑ 59 cm, Ø 25 cm  
incl. SMD-LED, 3,5 W  
300 lm, 2.800 K  
excl. 1 x E27, max. 40 W



522970206



↑ 165 cm, Ø 38 cm  
incl. SMD-LED, 15,5 W  
1.370 lm, 2.800 K  
excl. 1 x E27, max. 60 W



422970206



↓ 58 cm, Ø 35 cm  
excl. 1 x E27, max. 60 W



**500200107**  
**500200108**



↓ 160 cm, Ø 50 cm  
excl. 1 x E27, max. 60 W



**400200107**  
**400200108**



**07** Nickel matt · nickel mat  
**08** Messing matt · brass mat



## PARIS II

Nickel matt oder Messing matt · nickel mat or brass mat ·  
nickel mat ou laiton mat · nikkell mat of messing mat ·  
níquel mate o bronze mate · nichel opaco o ottone satinato ·  
nichel mat sau bronz mat · harjattu teräs tai mattamessinki ·  
nikiel mat lub mosiądz mat · mat nikel veya mat piring





Getrennt schaltbar · Separately switchable  
 Interrupteurs séparés · Gescheiden schakelbaar ·  
 Interruptores separados · Interruttori separati ·  
 Interrupatoare separate · Erikseen kytkettävissä ·  
 Oddzileny przełącznik · Dışarıdan anahtarlı



↓ 56 x 40 cm, ∅ 15 cm  
 incl. 1 x SMD, 5 W  
 450 lm, 3.000 K  
 excl. 1 x E27, max. 40 W

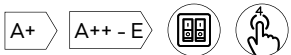

575210279  
 575210289



↓ 160 x 45 cm, ∅ 20 cm  
 incl. 1 x SMD, 13,5 W  
 1.100 lm, 3.000 K  
 excl. 1 x E27, max. 40 W

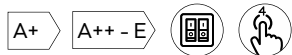

475210279  
 475210289



79 goldfarbig · gold  
 89 silberfarbig · silver

# NESTOR

Metall, Stoff · metal, fabric ·  
metale, tissu · metaal, textiel ·  
metal, tela metallo, tessuto ·  
metal, textil · metalli, tekstiili ·  
metal, tkanina · metal, kumaş



# NANDOR

Metall, Stoff · metal, fabric ·  
metale, tissu · metaal, textiel · metal, tela metallo, tessuto ·  
metal, textil · metalli, tekstiili · metal, tkanina · metal, kumaş

Getrennt schaltbar · Separately switchable  
Interrupteurs séparés · Gescheiden schakelbaar ·  
Interruttori separados · Interruttori separati ·  
Interrupatoare separate · Erikseen kytkettävissä ·  
Oddzielny przełącznik · Dışarıdan anahtarlı



79

07



↑ 62 cm, Ø 30 cm  
incl. 2 x SMD, 3 W  
2 x 300 lm, 3.000 K  
excl. 1 x E27, max. 40 W

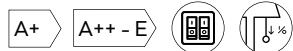

575310307  
575310379



↑ 160 cm, Ø 40 cm  
incl. 2 x SMD, 7 W  
2 x 600 lm, 3.000 K  
excl. 1 x E27, max. 40 W

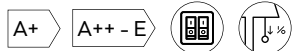

475310307  
475310379



07 Nickel matt · nickel mat  
79 goldfarbig · gold









## LINZ

chrom, Stoffschirm, schwarz/goldfarbig · chrome, fabric shade, black/gold ·  
chrome, abat-jour tissu, noir/or · chroom, Stoffen kap, zwart/goud ·  
cromo, Pantalla de tela, negro/oro · cromo, paralume in tessuto, nero/oro ·  
crom, abajur textil, negru/aur · kromi, kangas varjostin, musta/kultaa ·  
chrom, Klosz z materiału, czarny/złota · krom, Kumaş şapka, siyah/altın

456



↓ 200 cm, ↗ 165 cm  
excl. 1 x E27, max. 60 W



467400102

## GENT

Holz, Stoffschirm, schwarz/goldfarbig · wood, fabric shade, black/gold ·  
bois, abat-jour tissu, noir/or · hout, Stoffen kap, zwart/goud ·  
madera, Pantalla de tela, negro/oro · di legno, paralume in tessuto, nero/oro ·  
lemn, abajur textil, negru/aur · puu, kangas varjostin, musta/kultaa ·  
drewno, Klosz z materiału, czarny/złota · tahta, Kumaş şapka, siyah/altın

457



↑ 110 - 150 cm, ↔ 80 cm  
excl. 1 x E27, max. 60 W

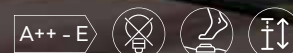

407400179

# LIÈGE

Holz, Metall · wood, metal ·  
bois, metale · hout, metaal · mader, metal · di legno, metallo ·  
lemn, metal · puu, metalli · drewno, metal · tahta, metal



31



32

458



↓ 29 cm, ↔ 22,5 cm, ↗ 28 cm  
excl. 1 x E14, max. 40 W

↓ 120 - 160 cm, ↔ 80 cm  
excl. 1 x E27, max. 60 W



507800131  
507800132

407800131  
407800132

31 weiß matt · white mat  
32 schwarz matt · black mat

# TEXEL

Metall schwarz matt/goldfarbig · metal black mat/gold ·  
metale noir mat/or · metaal mat zwart/goud · metal estera negra/oro ·  
metallo nero opaco/oro · metal negru mat/aur · metalli musta matto/kultaa ·  
metal czarny mat/złota · metal siyah mat/altın

LED SWITCHDIMMER

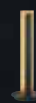

↑ 47,5 cm, Ø 16 cm  
incl. 1 x SMD-LED, 6,5 W  
660 lm, 3.000 K



574410179

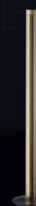

↑ 142 cm, Ø 25 cm  
incl. 1 x SMD-LED, 15 W  
1.450 lm, 3.000 K



474410179

# ANTWERP

Holz, chrom · wood, chrome ·  
bois, chrome · hout, chroom · mader, cromo · di legno, cromo ·  
lemn, crom · puu, kromi · drewno, chrom · tahta, krom



460



↔ 80 cm, ↓ 110 - 155 cm  
excl. 1 x E27, max. 42 W



407300106



↔ 36 cm, ↓ 66 cm  
excl. 1 x E14, max. 28 W



507300106



# SALIM

Rattangeflecht, Stoff · rattan meshwork, fabric ·  
maillage rotin, tissu · rotan vlechtwerk, textiel ·  
malla de rattan, tela · reticolo rattan, tessuto ·  
impletitura ratan, textil · rottinki, tekstiili ·  
rattan, tkanina · örgü, kumaş



462



↓ 110 cm, ↔ 35,5 x 20 cm  
excl. 2 x E14, max. 40 W



416600200



# GENT

Holz, Stoff weiß · wood, fabric white ·  
bois, tissu blanc · hout, textiel wit · maderá, tela blanco ·  
di legno, tessuto bianco · lemn, textil alb · puu, tekstiili valkoinen ·  
drewno, tkanina biały · tahta, kumaş beyaz



463



↔ 80 cm, ↓ 110-155 cm  
excl. 1 x E27, max. 60 W



407400101



## PEREZ

chrom, Marmor, Stoff · chrome, marble, fabric ·  
 chrome, marbre, tissu · chroom, marmer, textiel ·  
 cromo, mármol, tela · cromo, marmo, tessuto ·  
 crom, marmura, textil · kromi, marmori, tekstiili ·  
 chrom, marmur, tkanina · krom, mermer, kumaş



↑ 180 - 205 cm, ↗ 180 cm, Ø 50 cm  
 excl. 3 x E27, max. 60 W



421100301  
 421100302

01 weiß · white  
 02 schwarz · black

# SOLA

chrom, Marmor, Acryl · chrome, marble, acryl ·  
chrome, marbre, acryl · chroom, marmer, acryl ·  
cromo, mármol, acrílico · cromo, marmo, acrílico ·  
crom, marmura, acrilic · kromi, marmori, akryyli ·  
chrom, marmur, akryl · krom, mermer, akrilik

465

↑ 180 - 210 cm, ↗ 160 cm, Ø 40 cm  
excl. 1 x E27, max. 75 W



4200011-06

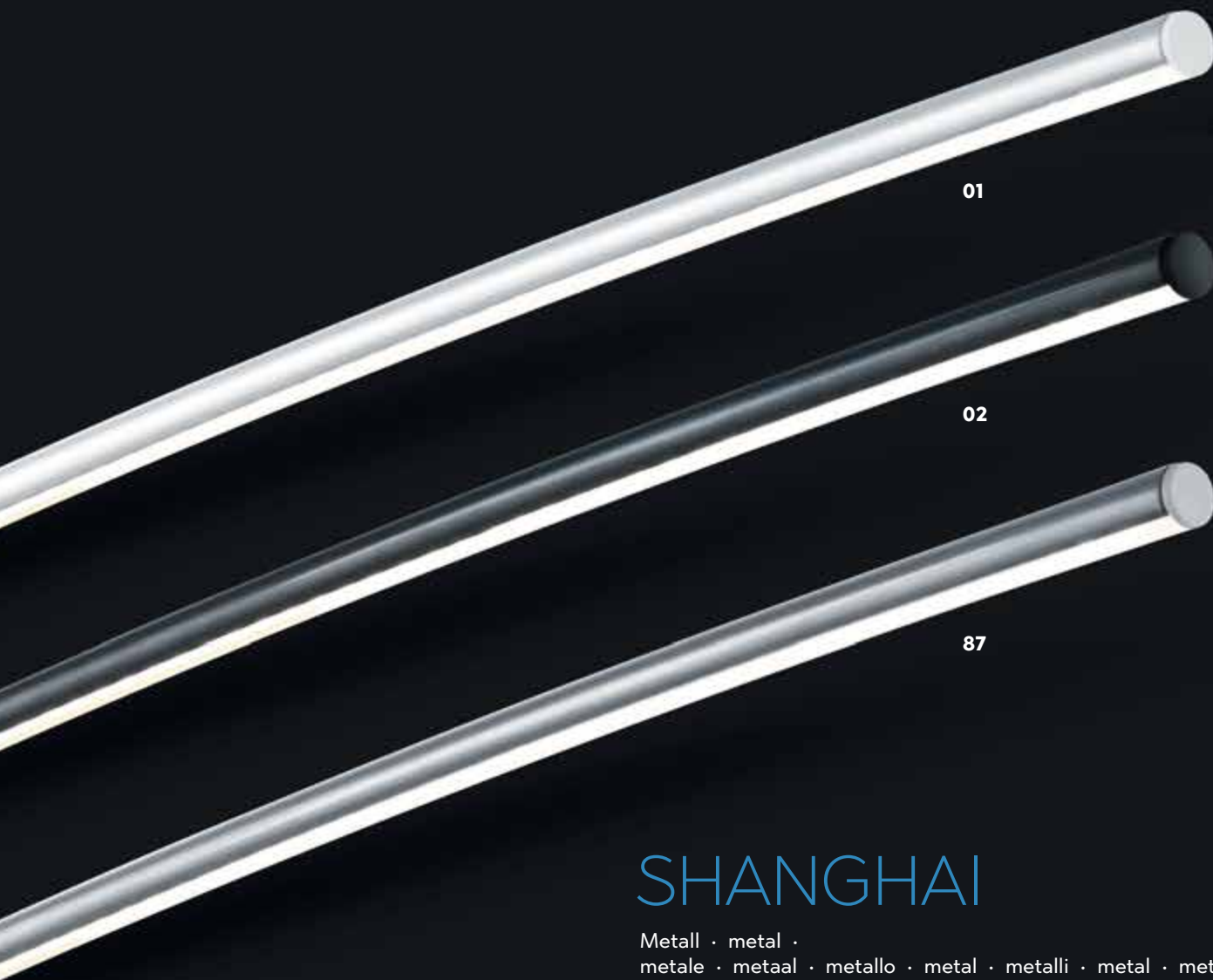

01

02

87

# SHANGHAI

Metall · metal ·  
metale · metaal · metallo · metal · metalli · metal · metal



466



↑ 210 cm, ↔ 65 cm, ↗ 200 cm  
incl. SMD-LED, 18 W  
1.800 lm, 3.000 K



427511801  
427511802  
427511887



**01** weiß · white  
**02** schwarz · black  
**87** titanfarbig · titanium-coloured





## CALGARY

Metall, weiß · metal, white ·  
metale, blanc · metaal, wit · metal, blanco ·  
metallo, bianco · metal, alb · metalli, valkoinen ·  
metal, biały · metal, beyaz



468



↑ 180 cm, ↗ 45 cm, Ø 38 cm  
incl. SMD-LED, 30 W  
2.100 lm, 3.000 K  
incl. SMD-LED, 5 W  
400 lm, 3.000 K



422510201



# FLORESTAN

Nickel matt · nickel mat ·  
nickel mat · nikkell mat · níquel mate · nichel opaco ·  
nichel mat · harjattu teräs · nikiel mat · mat nikel



469

↑ 183 cm, Ø 38 cm, √ 110 cm  
incl. 4 x SMD-LED, 4,5 W  
4 x 400 lm, 3.000 K



429910107



# MICHIGAN

Metall, Acryl · metal, acryl ·  
metale, acryl · metaal, acryl · metal, acrílico ·  
metallo, acrilico · metal, acrilic · metalli, akryyli ·  
metal, akryl · metal, akrilik

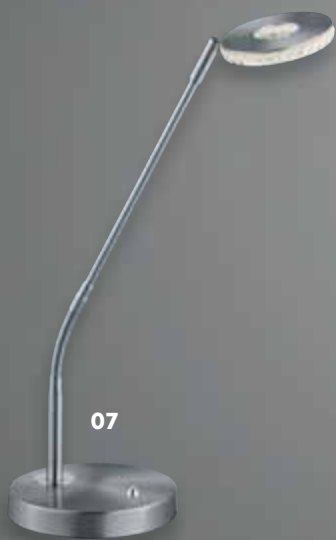

07



08



470



↓ 40 cm, ↗ 41 cm  
incl. 1 x SMD, 6 W  
600 lm, 3.000+4.200+6.500 K



↓ 130 cm, ↗ 50 cm  
incl. 1 x SMD, 6 W  
600 lm, 3.000+4.200+6.500 K



↓ 135 cm, ↔ 25 cm, ↗ 53 cm  
incl. 2 x SMD, 6 W  
2 x 600 lm, 3.000+4.200+6.500 K



↓ 180 cm, Ø 42 cm, ↗ 45 cm  
incl. 1 x SMD, 43 W  
4.300 lm  
incl. 1 x SMD, 6 W  
600 lm, 3.000+4.200+6.500 K



A+  
523810107  
523810108



A+  
423810107  
423810108



A+  
423810207  
423810208



A+  
423890207  
423890208



07 Nickel matt · nickel mat  
08 Messing matt · brass mat





schwenkbar · tiltable ·  
pivotant · draaibaar ·  
pivotante · girevole ·  
pivotant · suunnattava ·  
skrętny · eđilebilir





07

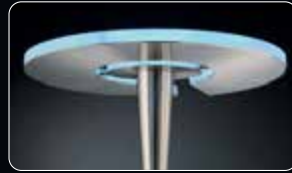

schwenkbar · tiltable ·  
pivotant · draaibaar ·  
pivotante · girevole ·  
pivotant · suunnattava ·  
skrętny · eĝilebilir



472

Dimmen und Lichtfarbe einstellen ·  
Dimming and adjusting light color ·  
Varier et choisir la couleur de la lumière ·  
Dimmen en lichtkleur instellen ·  
Atenuación y ajuste del color de la luz ·  
Variare e scegliere il colore della luce ·  
Variati lumina si ajustati culoarea luminii ·  
Himmennys ja värilämpötilan säätö vakiokytkimellä ·  
ściemniać i jasność ustawić ·  
Işıĝı kısmak ve rengini ayarlamak





08

## QUEBEC

Nickel matt oder Messing matt · nickel mat or brass mat ·  
nickel mat ou laiton mat · nikkell mat of messing mat ·  
níquel mate o bronze mate · nichel opaco o ottone satinato ·  
nichel mat sau bronz mat · harjattu teräs tai mattamessinki ·  
nikiel mat lub mosiądz mat · mat nikel veya mat piring



473



↑ 180 cm, ↗ 50 cm  
incl. SMD-LED, 34 W  
3.000 lm, 3.000 - 6.000 K  
incl. SMD-LED, 5,5 W  
400 lm, 3.000 - 6.000 K



422710307  
422710308

07 Nickel matt · nickel mat  
08 Messing matt · brass mat

# SPLIT

Nickel matt · nickel mat ·  
nickel mat · nikkell mat · níquel mate ·  
nichel opaco · nichel mat · harjattu teräs ·  
nikiel mat · mat nikel



474



↑ 180 cm, √ 43 cm  
incl. SMD-LED, 20 W  
2.000 lm, 3.000 - 5.500 K  
incl. 1 x SMD-LED, 3,5 W  
340 lm, 3.000 - 5.500 K



424910207

Stufenlos dimmbar, Lichtfarbe stufenlos einstellbar ·  
infinitely dimmable, light color infinitely variable ·  
infiniment dimmable, couleur de lumière infiniment  
variable · traploos dimbaar, lichtkleur traploos  
instelbaar · sin etapas regulable, color de luz  
infinitamente variable · infinitamente dimmerabile,  
colore della luce infinitamente variabile ·  
variator de lumina fara trepte, cu intrerupator  
standard de lumina · portaaton himmennys,  
valon väri portaattomasti · bezstopniowe  
ściemnianie, jasny kolor bezstopniowo ·  
fasilasız dim ayarı, açık renk sonsuz deđişken





475

# PILLAR

chrom, Acryl · chrome, acryl ·  
chrome, acryl · chroom, acryl · cromo, acrílico ·  
cromo, acrílico · crom, acrilic · krömi, akryyli ·  
chrom, akryl · krom, akrilik



↑ 150 cm, Ø 24 cm  
incl. 1 x SMD-LED, 24 W  
max. 2.000 lm, 3.000 K



423510101

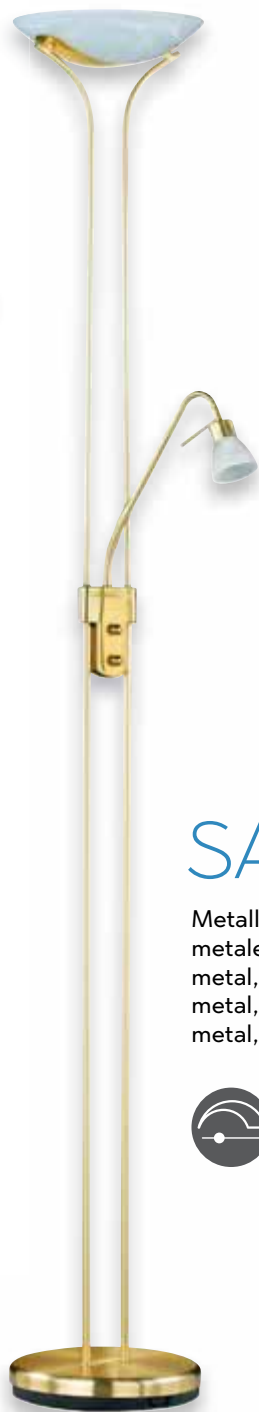

## SANTO

Metall, Glas alabasterfarbig · metal, alabaster-coloured glass ·  
metale, verre couleur albâtre · metaal, albastkleurig glas ·  
metal, vidrio de color alabastro · metallo, vetro colore alabastro ·  
metal, sticla culoare alabastru · metalli, lasi alabasteri väri ·  
metal, szkło alabaster kolor · metal, cam kaymaktaşı rengi



476



↑ 180 cm, Ø 25,5 cm, √ 40 cm  
incl. 1 x R7S, 230 W  
4.650 lm, 2.800 K  
incl. 1 x G9, 28 W  
370 lm, 2.800 K



431912107  
431912108  
431912124



**07** Nickel matt · nickel mat  
**08** Messing matt · brass mat  
**24** rostfarbig · rusty



## CASCO

rostfarbig, Scavo glas · rusty, scavo glass ·  
rouille, verre scavo · roestkleur, scavo glas ·  
óxido, vidrio scavo · ruggine, vetro scavo ·  
ruginiu, sticla scavo · rustiikki, scavo-lasi ·  
miedź, szkło scavo · pas, scavo cam



## LOPEZ

Nickel matt, Glas satiniert ·  
nickel mat, satinated glass ·  
nickel mat, verre satiné ·  
nikkel mat, gesatineerd glas ·  
níquel mate, vidrio satinado ·  
nichel opaco, vetro satinato ·  
nichel mat, sticla satinata ·  
harjattu teräs, satinoitu lasi ·  
nikiel mat, szkło satynowe ·  
mat nikel, satin cam



↓ 180 cm, Ø 31 cm, √ 43 cm  
incl. 1 x R7S, 230 W  
4.650 lm, 2.800 K  
incl. 1 x G9, 28 W  
370 lm, 2.800 K



4344021-24



↓ 180 cm, Ø 30 cm, √ 50 cm  
incl. 1 x R7S, 230 W  
4.650 lm, 2.800 K  
incl. 1 x G9, 28 W  
370 lm, 2.800 K

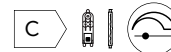

438410207



## SANTO II

Metall, Glas alabasterfarbig ·  
 metal, alabaster-coloured glass ·  
 metale, verre couleur albâtre ·  
 metaal, albastkleurig glas ·  
 metal, vidrio de color alabastro ·  
 metallo, vetro colore alabastro ·  
 metal, sticla culoare alabastru ·  
 metalli, lasi alabasteri väri ·  
 metal, szkło alabaster kolor ·  
 metal, cam kaymaktaşı rengi



07

28

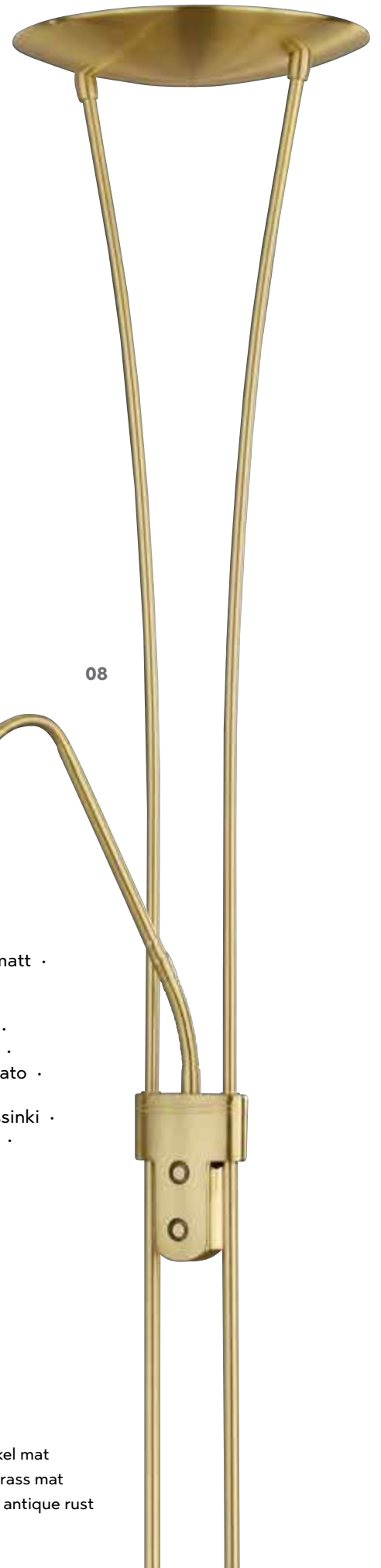

08

## ARIZONA

Nickel matt oder Messing matt ·  
 nickel mat or brass mat ·  
 nickel mat ou laiton mat ·  
 nikkell mat of messing mat ·  
 níquel mate o bronce mate ·  
 nichel opaco o ottone satinato ·  
 nichel mat sau bronz mat ·  
 harjattu teräs tai mattamessinki ·  
 nikiel mat lub mosiądz mat ·  
 mat nikel veya mat pirinç



**07** Nickel matt · nickel mat  
**08** Messing matt · brass mat  
**28** rostfarbig antik · antique rust

478



↓ 180 cm, Ø 25,5 cm, √ 40 cm  
 incl. 4 x SMD-LED, 4,5 W, 4 x 400 lm, 3.000 K  
 incl. 1 x SMD-LED, 4,5 W, 400 lm, 3.000 K



421910207  
 421910228

↓ 180 cm, Ø 25,5 cm, √ 40 cm  
 incl. SMD-LED, 20 W, 1.650 lm, 3.000 K  
 incl. 1 x SMD-LED, 5 W, 460 lm, 3.000 K

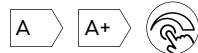

426410207  
 426410208





04

## ARANGO

Nickel matt oder altmessing · nickel mat or old brass ·  
nickel mat ou laiton fumé · nikkell mat of oud brons ·  
níquel mate o bronce viejo · nichel opaco o ottone invecchiato ·  
nichel mat sau bronz antic · harjattu teräs tai antiikkimessinki ·  
nikiel mat lub patyna · mat nikel veyá antik piringç

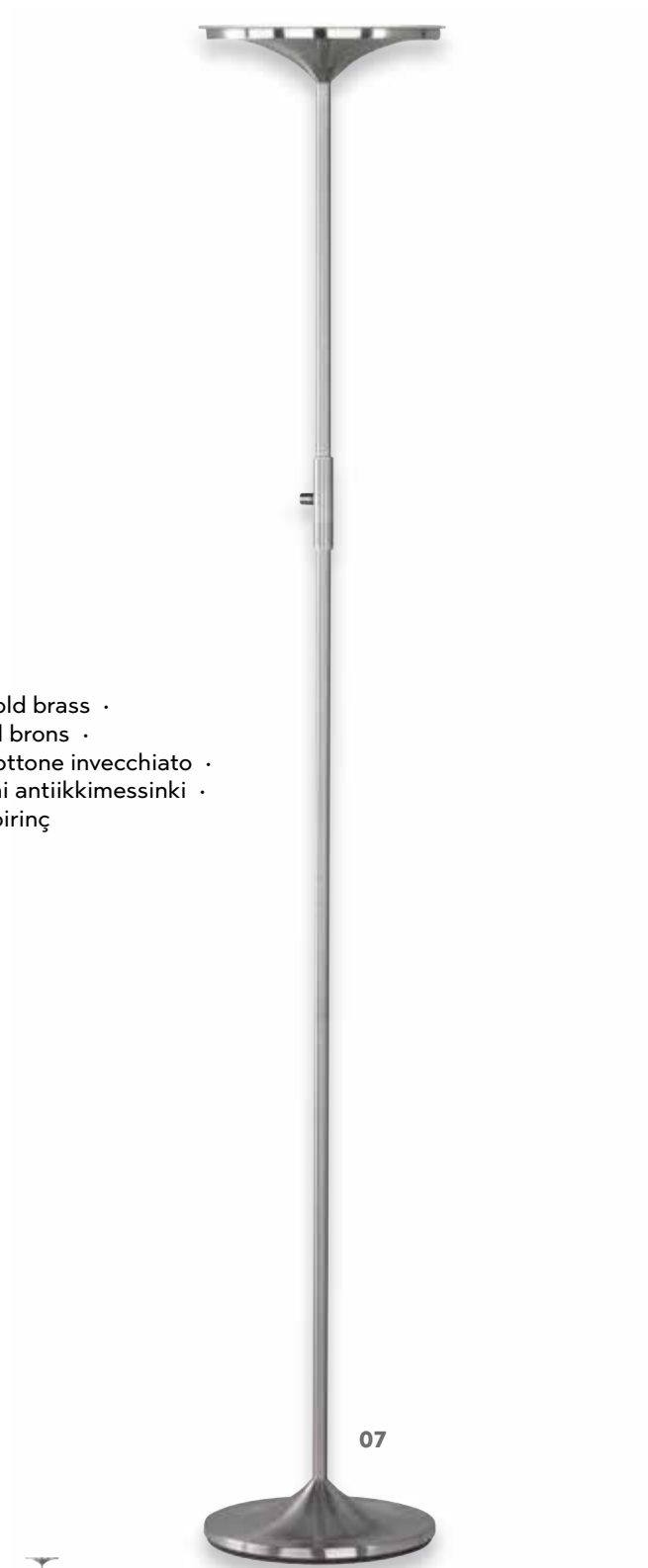

07



↓ 180 cm, Ø 31 cm  
incl. 1 x SMD-LED, 20 W  
1.750 lm, 3.000 K



429110104  
429110107



04 altmessing · old brass  
07 Nickel matt · nickel mat



08



↓ max. 85 cm, ↗ 70,5 cm  
incl. 1 x SMD-LED, 8,8 W  
950 lm, 3.000 K



523710107  
523710108



↓ max. 153 cm, ↗ 70,5 cm  
incl. 1 x SMD-LED, 8,8 W  
950 lm, 3.000 K



423710107  
423710108



07 Nickel matt · nickel mat  
08 Messing matt · brass mat



07

# AURORA II

Nickel matt oder Messing matt · nickel mat or brass mat ·  
nickel mat ou laiton mat · nikkell mat of messing mat · níquel mate o bronze mate ·  
nichel opaco o ottone satinato · nichel mat sau bronz mat · harjattu teräs tai mattamessinki ·  
nikiel mat lub mosiądz mat · mat nikel veyá mat piriņ



Sensordimmer · Sensor dimmer  
Variateur tactile · Touchdimmer ·  
Regulador con sensor · Touchdimmer ·  
Variator cu senzor · Kosketushimmennin ·  
Czujnik ściemniania · El dimeri



# BERGAMO

Nickel matt oder Messing matt · nickel mat or brass mat ·  
 nickel mat ou laiton mat · nikkell mat of messing mat ·  
 níquel mate o bronze mate · nichel opaco o ottone satinato ·  
 nichel mat sau bronz mat · harjattu teräs tai mattamessinki ·  
 nikiel mat lub mosiądz mat · mat nikel veya mat piring



Sensordimmer · Sensor dimmer  
 Variateur tactile · Touchdimmer ·  
 Regulador con sensor · Touchdimmer ·  
 Variator cu senzor · Kosketushimmennin ·  
 Czujnik ściemniania · El dimeri

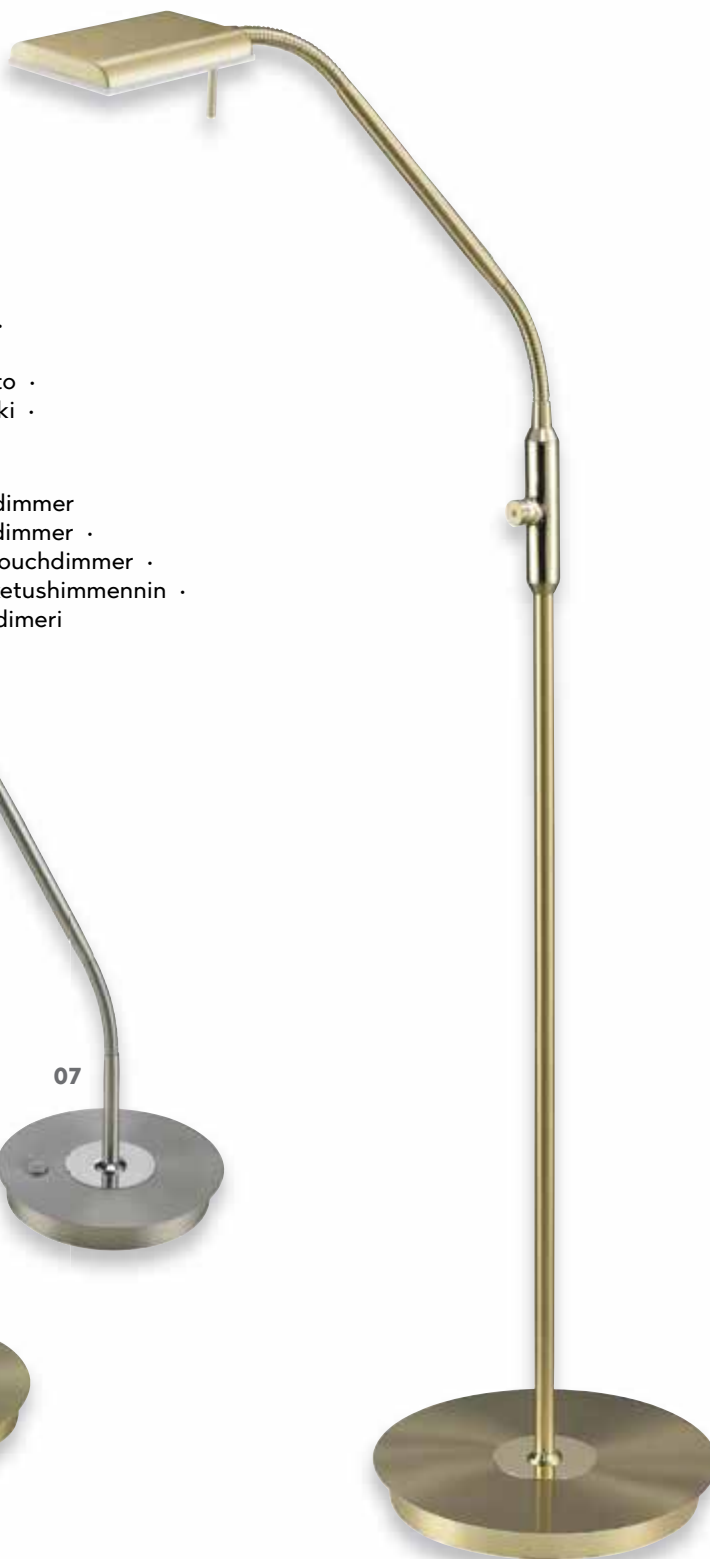

↑ 50 cm, ↗ 40 cm  
 incl. 1 x SMD-LED, 12 W  
 1.100 lm, 3.000 K



520910107  
 520910108



↑ 135 cm, ↗ 50 cm  
 incl. 1 x SMD-LED, 12 W  
 1.100 lm, 3.000 K



420910107  
 420910108



**07** Nickel matt · nickel mat  
**08** Messing matt · brass mat

# VERONA

Nickel matt · nickel mat ·  
nickel mat · nikkel mat · níquel mate · nichel opaco ·  
nichel mat · harjattu teräs · nikiel mat · mat nikel



Sensordimmer · Sensor dimmer  
Variateur tactile · Touchdimmer ·  
Regulador con sensor · Touchdimmer ·  
Variator cu senzor · Kosketushimmennin ·  
Czujnik ściemniania · El dimeri

483

↑ 130 cm, ↗ 70 cm  
incl. 1 x SMD-LED, 12 W  
1.100 lm, 3.000 K



420810107



07



01

## QUIDAM

Nickel matt oder weiß · nickel mat or white ·  
 nickel mat ou blanc · nikkell mat of wit ·  
 níquel mate o blanco · nichel opaco o bianco ·  
 nichel mat sau alb · harjattu teräs tai valkoinen ·  
 nikiel mat lub biały · mat nikel veya beyaz



4 fach Touch  
 4 level touch



↑ 100 - 150 cm, Ø 23 cm  
 incl. 2 x SMD-LED, 4,5 W  
 2 x 430 lm, 3.000 K



472490201  
 472490207

01 weiß · white  
 07 Nickel matt · nickel mat

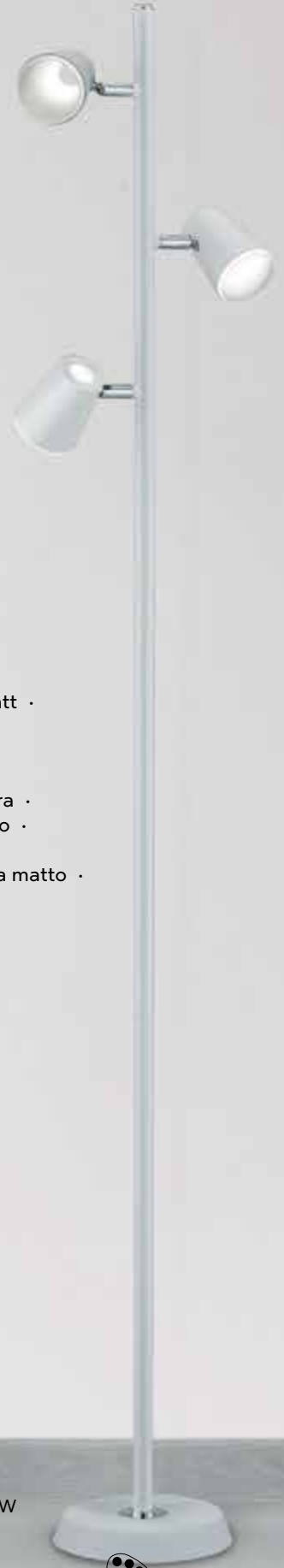

## NARCOS

Nickel matt, weiß matt oder schwarz matt ·  
nickel mat, white mat or black mat ·  
nickel mat, blanc mat ou noir mat ·  
nikkel mat, wit mat of mat zwart ·  
níquel mate, estera blanca o estera negra ·  
nichel opaco, bianco opaco o nero opaco ·  
nichel mat, alb mat sau negru mat ·  
harjattu teräs, valkoinen matto tai musta matto ·  
nikiel mat, biały mat lub czarny mat ·  
mat nikel, beyaz mat veya siyah mat

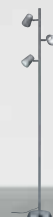

↑ 154 cm, ↔ 28 cm  
incl. 3 x SMD-LED, 4,7 W  
3 x 470 lm, 3.000 K



473190307  
473190331  
473190332



07 Nickel matt · nickel mat  
31 weiß matt · white mat  
32 schwarz matt · black mat



87

# PALO

Metall · metal ·  
metale · metaal · metal · metallo ·  
metal · metalli · metal · metal



02

01



87



↓ max. 40 cm, Ø 14 cm, √ 25 cm  
incl. SMD-LED, 3 W  
300 lm, 3.100 K

↓ 150 cm, Ø 20 cm, √ 40 cm  
incl. SMD-LED, 5 W  
480 lm, 3.100 K



524510101  
524510102  
524510187

424510187

01 weiß · white  
02 schwarz · black  
87 titanfarbig · titanium-coloured





## PALO II

Nickel matt · nickel mat ·  
nickel mat · nikkell mat · níquel mate · nichel opaco ·  
nichel mat · harjattu teräs · nikiel mat · mat nikel



On/off Touch



↓ 40 cm, Ø 14 cm, √ 25 cm  
incl. SMD-LED, 3 W  
300 lm, 3.100 K



524590107



↓ 130 cm, Ø 20 cm, √ 40 cm  
incl. SMD-LED, 5 W  
480 lm, 3.100 K



424590107



## ZIDANE

chrom oder Nickel matt · chrome or nickel mat ·  
 chrome ou nickel mat · chrom of nikkell mat ·  
 cromo o níquel mate · cromo o nichel opaco ·  
 crom sau nichel mat · kromi tai harjattu teräs ·  
 chrom lub nikiel mat · krom veyä mat nikel



## ICARO

Metall, Glas matt · metal, mat glass ·  
 metale, verre mat · metaal, mat glas ·  
 metal, vidrio mate · metallo, vetro sabbaiato ·  
 metal, sticla mata · metalli, mattalasi ·  
 metal, szkło matowane · metal, mat cam



07



↑ 145 cm, Ø 24 cm  
 incl. 3 x SMD-LED, 4,5 W  
 3 x 430 lm, 3.000 K



478610307



↑ 165 cm, 44 cm  
 excl. 1 x E27, max. 60 W



4035011-04  
 4035011-07  
 4035011-08



04 altmessing · old brass  
 07 Nickel matt · nickel mat  
 08 Messing matt · brass mat



07



32

# FILIGRAN

Nickel matt oder schwarz · nickel mat or black ·  
nickel mat ou noir · nikkell mat of zwart ·  
níquel mate o negro · nichel opaco o nero ·  
nichel mat sau negru · harjattu teräs tai musta ·  
nikiel mat lub czarny · mat nikel veya siyah



↓ 45 cm, ↗ 51 cm  
incl. 1 x SMD-LED, 6 W  
560 lm, 3.000 K

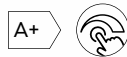

520490107



↓ 162 cm, ↗ 52 cm  
incl. 1 x SMD-LED, 6 W  
560 lm, 3.000 K

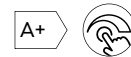

420490107  
420490132



**07** Nickel matt · nickel mat  
**32** schwarz matt · black mat

# MIAMI

Kunststoff, schwarz oder titanfarbig ·  
plastic, black or titan ·  
plastique, noir ou titane · kunststof, zwart of titaan ·  
plástico, negro o titán · plastica, nero o titano ·  
plastic, negru sau titaniu · muovi, musta tai titaani ·  
plastik, czarny lub tytanowy · plastik, siyah veya titan



induktive Ladestation · inductive loading station ·  
station de chargement inductif · inductief laadstation ·  
estación de carga inductiva · stazione di carico  
induttivo · stație de încărcare inductivă · induktiivinen  
latausasema · stacja ładowania indukcyjnego ·  
endüktif yükleme istasyonu

87



490



↑ 50 cm, ↔ 18 cm, √ 29 cm  
incl. 1 x SMD-LED, 5 W  
600 lm, 3.000 + 4.000 + 5.000 K



570190102  
570190187

02 schwarz · black  
87 titanfarbig · titanium-coloured



# RADO

Metall, Kunststoff · metal, plastic ·  
metale, plastique · metaal, kunststof ·  
metal, plástico · metallo, plastica · metal, plastic ·  
metalli, muovi · metal, plastik · metal, plastik



↑ 70 cm, ↗ 38 cm  
incl. 1 x SMD-LED, 5 W  
550 lm, 3.000 + 4.000 + 5.000 K



527690131  
527690132



**31** weiß matt · white mat  
**32** schwarz matt · black mat



## RODERIC

Metall, Kunststoff · metal, plastic ·  
metale, plastique · metaal, kunststof · metal, plástico ·  
metallo, plastica · metal, plastic · metalli, muovi ·  
metal, plastik · metal, plastik

01



42

492



↑ 60 cm, ↗ 55 cm  
incl. 1 x SMD-LED, 6 W  
670 lm, 3.000 K



527410101  
527410142



01 weiß · white  
42 anthrazit · anthracite



# AMSTERDAM

Metall · metal ·  
metale · metaal · metallo · metal ·  
metalli · metal · metal

02

01

493



↑ max. 90 cm, ↗ max. 90 cm, Ø 18 cm  
incl. 1 x COB-LED, 5 W  
500 lm, 3.000 K



527920101  
527920102



01 weiß · white  
02 schwarz · black



## POLO

Kunststoff · plastic ·  
 plastique · kunststof · plástico ·  
 plastica · plastic · muovi ·  
 plastik · plastik



## SWAN

Aluminium, Kunststoff · aluminium, plastic ·  
 aluminium, plastique · aluminium, kunststof ·  
 aluminio, plástico · alluminio, plastica ·  
 aluminiu, plastic · alumiini, muovi ·  
 aluminium, plastik · alüminyum, plastik



02



## LORIS

Kunststoff, titanfarbig · plastic, titan ·  
 plastique, titane · kunststof, titaan ·  
 plástico, titán · plastica, titano ·  
 plastic, titaniu · muovi, titaani ·  
 plastik, tytanowy · plastik, titan



↓ 41 cm, ↗ 40 cm  
 incl. 1 x SMD-LED, 5 W  
 550 lm, 3.000 + 4.000 + 5.000 K



527090111  
 527090131



↓ 50 cm, ↔ 16 cm, ↗ 45 cm  
 incl. 1 x SMD-LED, 7 W  
 470 lm, 2.500 - 4.000 K



523910101  
 523910102



↓ 45 cm, ↔ 12 cm, ↗ 47  
 incl. 1 x SMD-LED, 5,5 W  
 500 lm, 3.000 + 5.000 K



526290187



01 weiß · white  
 02 schwarz · black  
 11 grau · grey  
 31 weiß matt · white mat  
 87 titanfarbig · titan





# GRANDE

Kunststoff · plastic ·  
plastique · kunststof · plástico · plastica ·  
plastic · muovi · plastik · plastik



495



↑ 62 cm, ↗ 40 cm  
incl. 1 x SMD-LED, 9 W  
1.300 lm, 3.000 + 4.000 + 5.000 K



525690101  
525690111

**01** weiß · white  
**11** grau · grey



01



87

## ARKO

Kunststoff · plastic ·  
plastique · kunststof · plástico ·  
plastica · plastic · muovi · plastik · plastik

496



↑ 35 cm, ↔ 28 x 14 cm, ↗ 43 cm  
incl. 1 x SMD-LED, 4 W, 360 lm, 3.000 K  
incl. 1 x SMD-LED, 4 W, 400 lm, 5.000 K



577390101  
577390187



**01** weiß · white  
**87** titanfarbig · titanium-coloured



# VARIO

Metall, Kunststoff · metal, plastic ·  
metale, plastique · metaal, kunststof · metal, plástico ·  
metallo, plastica · metal, plastic · metalli, muovi ·  
metal, plastik · metal, plastik



87

02



↑ max. 64,5 cm, ↗ max. 50 cm  
incl. SMD-LED, 3,6 W  
200 lm, 3.000 K



- 01 weiß · white
- 02 schwarz · black
- 87 titanfarbig · titanium-coloured



- 522520101
- 522520102
- 522520187



## LUPO

Kunststoff · plastic ·  
 plastique · kunststof · plástico ·  
 plastica · plastic · muovi · plastik · plastik



4 fach Touch  
 4 level touch



↓ 35 cm, Ø 13,5 cm, √ 30 cm  
 incl. 1 x SMD-LED, 5 W  
 550 lm, 3.500 K



527290101  
 527290102



↓ 35 cm, Ø 13,5 cm, √ 30 cm  
 incl. 1 x SMD-LED, 5 W  
 550 lm, 3.500 K



227280101  
 227280102



**01** weiß · white  
**02** schwarz · black

Formeln der geometrischen Optik  
den Vergleich ähnlicher  
Darstellung der geometrischen  
Verhältnisse, ermitteln  
Abbildungsgrößen  
Bildungsgleichung

DP und MP ähnlich  
O und O' recht  
W, gleiche  
folgende

Der Abb.  
Der Abb.  
Verhältnis der  
der Bildvergrößerung  
sagt, in welchem Ver  
and auf der Filmebene

Abbildungsmaßstab ist das Verhältnis zwischen  
der Abbildung und der Größe  
des Originalen. Ein Maßstab von 1:1  
würde gleich groß abgebildet  
zu, fotografierende Gegenstände  
Abbildung 1:2 hingegen nur halb  
abgebildet und der Gegenstand  
dargestellt so, wie er doppelte  
genau gleich groß dargestellt  
genau einer halben Größe  
genau land.

Praxis wissen  
abgebildet wird, je größer die  
Distanz (Dingweite) ist, desto  
kleiner die Aufnahme (Bildweite).  
bleibende Aufnahme-Distanz ist.  
die Objektivbrennweite ist. Wenn wir  
mit einem Vario-Objektiv bei gleichblei-

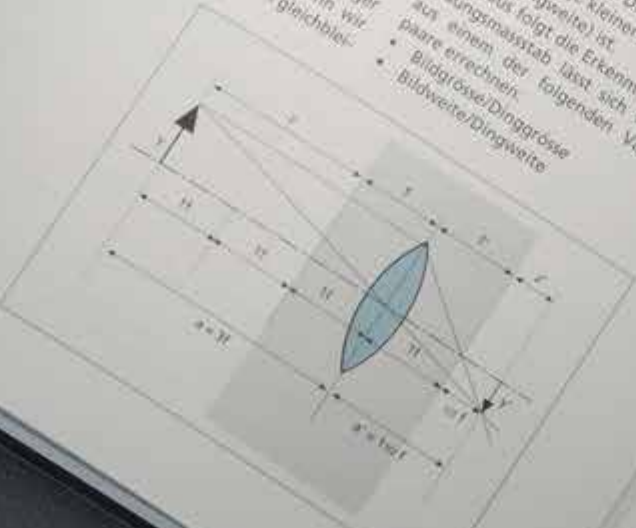

Der Abbildungsmaßstab (m = 1:2)

... bilden  
das Verhältniss a  
:1. Zwar weniger bi  
n rechnerische Zwer  
er erlaubt, ist die  
massstabes a

Aufnahmestandpunkt ein Ob  
eranziehen, machen wir nicht  
als die Brennweite verlängern  
bei den Abbildungsmaßstab ver  
-Weil der Bildausschnitt ver  
informaten dabei gleich bleibt  
in wir lediglich einen Ausschnitt  
mehr grösseren Bildes.  
Abbildungsmaßstab hängt sowohl von der Aufnah  
Distanz als auch von der Objektiv  
Aus Erfahrung und aus den bisher  
gen Betrachtungen wissen wir, dass der  
Kameraauszug (die Bildweite) gleich  
groß ist wie die Brennweite, wenn sich  
der Aufnahmegegenstand unendlich  
weit weg befindet. Die Bildweite wird  
um so grösser, je kleiner die Aufnahme  
Distanz (Dingweite) ist.  
Daraus folgt die Erkenntnis: Der Ab  
bildungsmaßstab lässt sich wahlweise  
aus einem der folgenden Variablen  
paare errechnen  
• Bildgröße/Dinggröße  
• Bildweite/Dingweite



## PRETO

Metall, Kunststoff · metal, plastic ·  
 metale, plastique · metaal, kunststof ·  
 metal, plástico · metallo, plastica ·  
 metal, plastic · metalli, muovi ·  
 metal, plastik · metal, plastik



06

## POLLY

Kunststoff · plastic ·  
 plastique · kunststof ·  
 plástico · plastica ·  
 plastic · muovi ·  
 plastik · plastik



01



02



↓ max. 40 cm, ↗ 25 cm  
 incl. SMD, 3,8 W  
 350 lm, 3.100 K



528310107



↓ max. 40 cm, ↗ 40 cm  
 incl. SMD, 3,8 W  
 350 lm, 3.100 K



528380107



↓ 40 cm, ↔ 16 x 16 cm, ↗ 39 cm  
 incl. 1 x SMD, 4,8 W  
 450 lm, 3.000 K



573910101  
 573910102  
 573910106



01 weiß · white  
 02 schwarz · black  
 06 chrom · chrome  
 07 Nickel matt · nickel mat

# KOLIBRI

Metall, Kunststoff · metal, plastic ·  
metale, plastique · metaal, kunststof · metal, plástico ·  
metallo, plastica · metal, plastic · metalli, muovi ·  
metal, plastik · metal, plastik



01



07



06



15

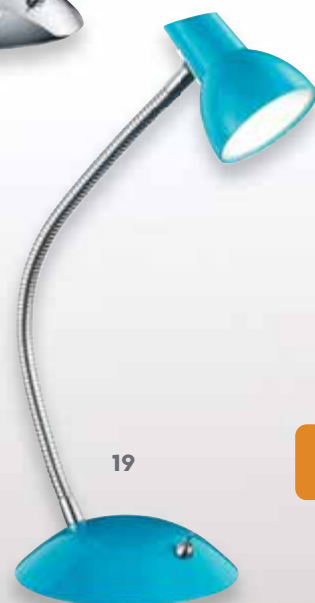

19



↑ 35 cm, ↗ 32 cm  
incl. 1 x SMD, 4,4 W  
450 lm, 3.000 K



527810101  
527810106  
527810107  
527810115  
527810119

01 weiß · white  
06 chrom · chrome  
07 Nickel matt · nickel mat  
15 grün · green  
19 türkis ·



47

## TAJO

Metall · metal ·  
metale · metaal · metal · metallo ·  
metal · metalli · metal · metal



17

01

502



↓ 73,5 cm, ↗ 51 cm  
excl. 1 x E27, max. 40 W



5029010-01  
5029010-17  
5029010-47



01 weiß · white  
17 mehrfarbig · multicolor  
47 anthrazit · anthracite





## PRONTO

Metall, Kunststoff · metal, plastic ·  
 metale, plastique · metaal, kunststof · metal, plástico ·  
 metallo, plastica · metal, plastic · metalli, muovi ·  
 metal, plastik · metal, plastik



## FLEXO

Metall, Kunststoff · metal, plastic ·  
 metale, plastique · metaal, kunststof · metal, plástico ·  
 metallo, plastica · metal, plastic · metalli, muovi ·  
 metal, plastik · metal, plastik



↓ 30 cm, ↗ 22 cm  
 excl. 1x E27, max. 18 W



**5027011-01**  
**5027011-17**  
**5027011-47**



↓ 30 cm, ↗ 30 cm  
 excl. 1x E14, max. 18 W



**5028010-01**  
**5028010-02**  
**5028010-17**  
**5028010-47**



**01** weiß · white  
**02** schwarz · black  
**17** mehrfarbig · multicolor  
**47** silberfarbig · silver-coloured



07

## DONNA

Metall, Glas alabasterfarbig · metal, alabaster-coloured glass ·  
 metale, verre couleur albâtre · metaal, albastkleurig glas ·  
 metal, vidrio de color alabastro · metallo, vetro colore alabastro ·  
 metal, sticla culoare alabastro · metalli, lasi alabasteri väri ·  
 metal, szkło alabaster kolor · metal, cam kaymaktaşı rengi



08



32

## EMERALD

Metall, Glas matt · metal, mat glass ·  
 metale, verre mat · metaal, mat glas ·  
 metal, vidrio mate · metallo, vetro sabbiato ·  
 metal, sticla mata · metalli, mattalasi ·  
 metal, szkło matowane · metal, mat cam



06

79



07



↓ 30 cm, Ø 22,5 cm  
 incl. 1 x SMD-LED, 4 W  
 350 lm, 3.000 K



525790107  
 525790108  
 525790132



↓ 29 cm, Ø 15 cm  
 incl. 1 x SMD-LED, 4 W  
 350 lm, 3.000 K

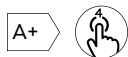

525490106  
 525490107  
 525490179



06 chrom · chrome  
 07 Nickel matt · nickel mat  
 08 Messing matt · brass mat  
 32 schwarz matt · black mat  
 79 goldfarbig · gold

# BERLIN

Metall, Glas matt · metal, mat glass ·  
metale, verre mat · metaal, mat glas ·  
metal, vidrio mate · metallo, vetro sabbiato ·  
metal, sticla mata · metalli, mattalasi ·  
metal, szkło matowane · metal, mat cam



79



07

505



↑ 39 cm, Ø 19,5 cm  
incl. 1 x SMD-LED, 4 W  
350 lm, 3.000 K



527590107  
527590179



07 Nickel matt · nickel mat  
79 goldfarbig · gold



00



07

## CRISTO

chrom oder Nickel matt, Glas · chrome or nickel mat, glass ·  
 chrome ou nickel mat, verre · chrom of nikkell mat, glas ·  
 cromo o níquel mate, vidrio · cromo o nichel opaco, vetro ·  
 crom sau nichel mat, sticla · kromi tai harjattu teräs, lasi ·  
 chrom lub nikiel mat, szkło · krom veya mat nikel, cam



## MONTI

Metall, Glas · metal, glass ·  
 metale, verre · metaal, glas ·  
 metal, vidrio · metallo, vetro ·  
 metal, sticla · metalli, lasi ·  
 metal, szkło · metal, cam



07



## MORTEN

Metall, Glas alabasterfarbig · metal, alabaster-coloured glass ·  
 metale, verre couleur albâtre · metaal, albastkleurig glas ·  
 metal, vidrio de color alabastro · metallo, vetro colore alabastro ·  
 metal, sticla culoare alabastru · metalli, lasi alabasteri väri ·  
 metal, szkło alabaster kolor · metal, cam kaymaktaşı rengi



↑ 15 cm, Ø 11 cm  
 incl. 1 x SMD-LED, 4,5 W  
 400 lm, 3.000 K



529690100  
 529690107



↑ 25,5 cm, Ø 15 cm  
 incl. 1 x LED E14, 4 W  
 320 lm, 3.000 K



529310107



↔ 15 x 8 cm, ↑ 18,5 cm  
 excl. 1 x G9, max. 8 W



592000107



00 transparent · transparent  
 07 Nickel matt · nickel mat



## VENTURA

Metall, Glas matt · metal, mat glass ·  
 metale, verre mat · metaal, mat glas · metal, vidrio mate ·  
 metallo, vetro sabbiato · metal, sticla mata · metalli, mattalasi ·  
 metal, szkło matowane · metal, mat cam



4 fach Touch  
 4 level touch



↑ 28 cm, Ø 15,5 cm  
 incl. 1 x SMD-LED, 5 W  
 400 lm, 3.000 K



529990103  
 529990106  
 529990107  
 529990124



03 Messing poliert · polished brass  
 06 chrom · chrome  
 07 Nickel matt · nickel mat  
 24 rostfarbig · rusty



## HENK

Metall, Glas alabasterfarbig ·  
 metal, alabaster-coloured glass ·  
 metale, verre couleur albâtre ·  
 metaal, albastkleurig glas ·  
 metal, vidrio de color alabastro ·  
 metallo, vetro colore alabastro ·  
 metal, sticla culoare alabastru ·  
 metalli, lasi alabasteri väri ·  
 metal, szkło alabaster kolor ·  
 metal, cam kaymaktaşı rengi



## GERRIT

Metall, Glas alabasterfarbig ·  
 metal, alabaster-coloured glass ·  
 metale, verre couleur albâtre ·  
 metaal, albastkleurig glas ·  
 metal, vidrio de color alabastro ·  
 metallo, vetro colore alabastro ·  
 metal, sticla culoare alabastru ·  
 metalli, lasi alabasteri väri ·  
 metal, szkło alabaster kolor ·  
 metal, cam kaymaktaşı rengi



↓ 38 cm, Ø 26 cm  
 excl. 1 x E14, max. 40 W

↓ 25 cm, Ø 15 cm  
 excl. 1 x E14, max. 40 W



5925011-07  
 5925011-08

5930011-01  
 5930011-24

01 weiß · white  
 07 Nickel matt · nickel mat  
 08 Messing matt · brass mat  
 24 rostfarbig · rusty



## JOOST

Nickel matt, Glas matt · nickel mat, mat glass ·  
 nickel mat, verre mat · nikkell mat, mat glas ·  
 níquel mate, vidrio mate · nichel opaco, vetro sabbiato ·  
 nichel mat, sticla mata · harjattu teräs, mattalasi ·  
 nikiel mat, szkło matowane · mat nikel, mat cam

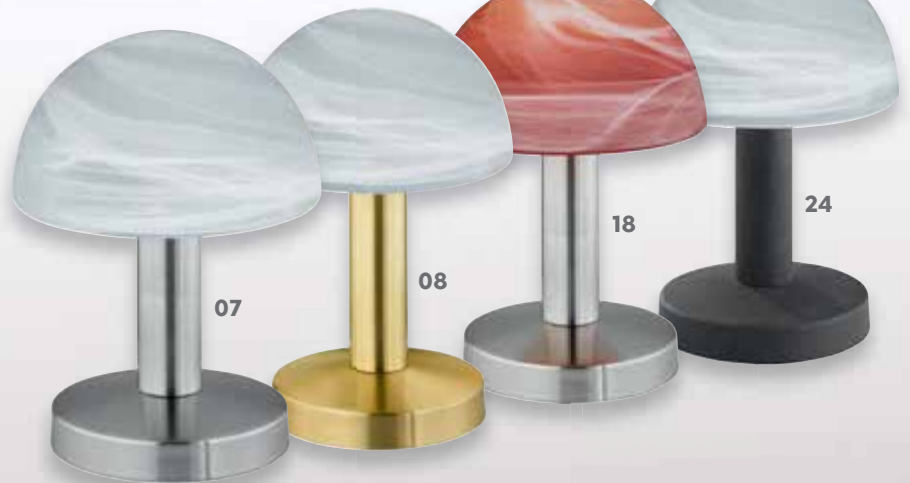

## FYNN

Metall, Glas alabasterfarbig · metal, alabaster-coloured glass ·  
 metale, verre couleur albâtre · metaal, albastkleurig glas ·  
 metal, vidrio de color alabastro · metallo, vetro colore alabastro ·  
 metal, sticla culoare alabastru · metalli, lasi alabasteri väri ·  
 metal, szkło alabaster kolor · metal, cam kaymaktaş ı rengi



↓ 39 cm, Ø 19 cm  
 excl. 1 x E27, max. 60 W



5922011-07



↓ 21 cm, Ø 15 cm  
 excl. 1 x E14, max. 40 W



599000106  
 599000107  
 599000108  
 599000118  
 599000124



06 chrom · chrome  
 07 Nickel matt · nickel mat  
 08 Messing matt · brass mat  
 18 orange · orange  
 24 rostfarbig · rusty



## TILL

Nickel matt, Glas matt · nickel mat, mat glass ·  
 nickel mat, verre mat · nikkell mat, mat glas ·  
 níquel mate, vidrio mate · nichel opaco, vetro sabbaiato ·  
 nichel mat, sticla mata · harjattu teräs, mattalasi ·  
 nikiel mat, szkło matowane · mat nikel, mat cam



07

04

## DAVI

Metall, Glas matt · metal, mat glass ·  
 metale, verre mat · metaal, mat glas ·  
 metal, vidrio mate · metallo, vetro sabbaiato ·  
 metal, sticla mata · metalli, mattalasi ·  
 metal, szkło matowane · metal, mat cam



## SETA

Nickel matt, Glas · nickel mat, glass ·  
 nickel mat, verre · nikkell mat, glas ·  
 níquel mate, vidrio · nichel opaco, vetro ·  
 nichel mat, sticla · harjattu teräs, lasi ·  
 nikiel mat, szkło · mat nikel, cam



## ARY

Nickel matt, Glas matt · nickel mat, mat glass ·  
 nickel mat, verre mat · nikkell mat, mat glas ·  
 níquel mate, vidrio mate · nichel opaco, vetro sabbaiato ·  
 nichel mat, sticla mata · harjattu teräs, mattalasi ·  
 nikiel mat, szkło matowane · mat nikel, mat cam



↓ 21 cm, Ø 8,5 cm  
 incl. 1 x LED E14, 4 W  
 320 lm, 3.000 K



574090107



↓ 15 cm, ↔ 10 x 15 cm  
 excl. 1 x E14, max. 40 W



5901011-07



↓ 16 cm, ↔ 10 x 15 cm  
 excl. 1 x E14, max. 40 W



5900011-04  
 5900011-07



↓ 15 cm, Ø 9 cm  
 excl. 1 x E14, max. 40 W



5908011-07



04 altmessing · old brass  
 07 Nickel matt · nickel mat





00



42



92

## LACAN

chrom, Acryl · chrome, acryl ·  
chrome, acryl · chroom, acryl · cromo, acrílico ·  
cromo, acrilico · crom, acrilic · kromi, akryyli ·  
chrom, akryl · krom, akrilik



07



08



06



24

## LUIS

Metall, Glas alabasterfarbig ·  
metal, alabaster-coloured glass ·  
metale, verre couleur albâtre ·  
metaal, albastkleurig glas ·  
metal, vidrio de color alabastro ·  
metallo, vetro colore alabastro ·  
metal, sticla culoare alabastru ·  
metalli, lasi alabasteri väri ·  
metal, szkło alabaster kolor ·  
metal, cam kaymaktaşı rengi



↑ 32 cm, Ø 12  
excl. 1 x E14, max. 40 W



595500106  
595500107  
595500108  
595500124



↑ 30 cm, Ø 13 cm  
excl. 1 x E14, max. 40 W



593900100  
593900142  
593900192



00 transparent · transparent  
06 chrom · chrome  
07 Nickel matt · nickel mat  
08 Messing matt · brass mat  
24 rostfarbig · rusty  
42 anthrazit · antracite  
92 purpurrot · purple



CHERRY



SAVANNAH



DAYTONA

Marmor, Stoffschirm · marble, fabric shade ·  
 marbre, abat-jour tissu · marmer, Stoffen kap ·  
 mármol, Pantalla de tela · marmo, paralume in tessuto ·  
 marmura, abajur textil · marmori, kangas varjostin ·  
 marmur, Klosz z materiału · mermer, Kumaş şapka



↓ 27 cm, ↔ 16 x 16 cm  
 excl. 1 x E14, max. 40 W



504000101  
 504000102



↓ 27 cm, Ø 18 cm  
 excl. 1 x E14, max. 40 W



503900101  
 503900102



↓ 26 cm, Ø 15 cm  
 excl. 1 x E14, max. 40 W



503600101  
 503600102



↓ 31 cm, Ø 15 cm  
 excl. 1 x E14, max. 40 W



503200101  
 503200102



01 weiß · white  
 02 schwarz · black

Leuchten aus echtem Marmor bestechen durch die natürliche und einzigartige Maserung, die jede Leuchte zu einem Unikat macht ·

Luminaires made of real marble impress with their natural and unique pattern, which makes every lamp to one of a kind ·

Luminaires en marbre véritable. Le grain naturel qui les constitue donne à chaque lampe une apparence propre et rend chaque modèle unique ·

Armaturen gemaakt van echt marmer hebben een eigen natuurlijke tekening, die elke lamp uniek maakt ·

Las luminarias de mármol genuino impresionan por su veta natural y única que hace que cada lámpara sea diferente ·

Gli apparecchi, realizzati in marmo, colpiscono con il loro grano naturale, che rende ogni lampada unica ·

Corpurile de iluminat facute din marmura adevărată impresionează cu granulația lor unică și naturală, care face din fiecare lampă un unicat ·

Valaisimet jotka on tehty oikeasta marmorista tekevät vaikutuksen niiden luonnollisella ja yksilöllisellä kuvioinnilla joka tekee jokaisesta kappaleesta yksilöllisen sekä ainutlaatuisen ·

Oprawy wykonane z prawdziwego marmuru zachwyca naturalny i niepowtarzalny mazerunek, który sprawia, że każda lampa jest jedyna w swoim rodzaju ·

Her bir ürünü eşsiz kılan doğal dokusuyla etkileyici gerçek mermerden yapılmış aydınlatma ürünleri.



ORLANDO



## MATS

Nickel matt, Stoff · nickel mat, fabric ·  
 nickel mat, tissu · nikkell mat, textiel · níquel mate, tela ·  
 nichel opaco, tessuto · nichel mat, textil · harjattu teräs, tekstiili ·  
 nikiel mat, tkanina · mat nikel, kumaş



↓ 24 cm, Ø 14 cm  
 excl. 1 x E14, max. 40 W



599600101  
 599600102  
 599600115  
 599600119  
 599600142



**01** weiß · white  
**02** schwarz · black  
**15** grün · green  
**19** türkis · turquoise  
**42** anthrazit · anthacite





## PIET

Nickel matt, Stoff · nickel mat, fabric ·  
 nickel mat, tissu · nikkel mat, textiel ·  
 níquel mate, tela · nichel opaco, tessuto ·  
 nichel mat, textil · harjattu teräs, tekstiili ·  
 nikiel mat, tkanina · mat nikel, kumaş



42



## WIM

chrom, Stoff · chrome, fabric ·  
 chrome, tissu · chroom, textiel · cromo, tela ·  
 cromo, tessuto · crom, textil · kromi, tekstiili ·  
 chrom, tkanina · krom, kumaş



↑ 30 cm, Ø 15,5 cm  
 excl. 1 x E14, max. 40 W



5960011-01  
 5960011-02



↑ 35,5 cm, ↔ 12 x 12 cm  
 excl. 1 x E14, max. 40 W



5914011-01  
 5914011-02  
 5914011-10  
 5914011-42



01 weiß · white  
 02 schwarz · black  
 10 rot · red  
 42 anthrazit · anthracite





## Spotserien

Spots  
Spotterie  
Spots  
Focos  
Faretti  
Spoturi  
Spotit  
Reflektorki  
Spotlar



07

# CUBA

Nickel matt oder weiß matt · nickel mat or white mat ·  
 nickel mat ou blanc mat · nikkell mat of wit mat ·  
 níquel mate o estera blanca · nichel opaco o bianco opaco ·  
 nichel mat sau alb mat · harjattu teräs tai valkoinen matto ·  
 nikiel mat lub biały mat · mat nikel veya beyaz mat

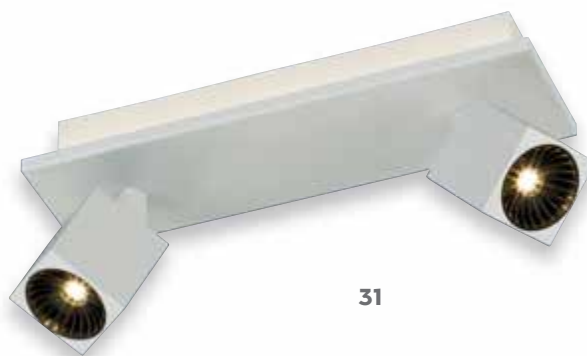

31



1x

2x

3x

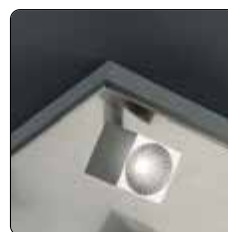

Getrennt schaltbar · Separately switchable  
 Interrupteurs séparés · Gescheiden schakelbaar ·  
 Interruptores separados · Interruttori separati ·  
 Intreruptoare separate · Erikseen kytkettävissä ·  
 Oddzileny przełącznik · Dışarıdan anahtarlı



↔ 10 x 15 cm, ↗ 15 cm  
 incl. 1 x SMD-LED, 4,3 W  
 430 lm, 3.000 K  
 incl. 1 x SMD, 3 W  
 280 lm, 3.000 K



828570207  
 828570231

↔ 30 x 8,5 cm, ↑ 14 cm  
 incl. 2 x SMD-LED, 4,3 W  
 2 x 430 lm, 3.000 K  
 incl. 1 x SMD, 4 W  
 330 lm, 3.000 K



828510307  
 828510331

↔ 55 x 8,5 cm, ↑ 15,5 cm  
 incl. 3 x SMD-LED, 4,3 W  
 3 x 430 lm, 3.000 K  
 incl. 1 x SMD, 8 W  
 640 lm, 3.000 K



828510407  
 828510431

↔ 86 x 8,5 cm, ↑ 18 cm  
 incl. 4 x SMD-LED, 4,3 W  
 4 x 430 lm, 3.000 K  
 incl. 1 x SMD, 8 W  
 640 lm, 3.000 K



828510507  
 828510531

↔ 28 x 28 cm, ↑ 14 cm  
 incl. 4 x SMD-LED, 4,3 W  
 4 x 430 lm, 3.000 K  
 incl. 1 x SMD, 8 W  
 640 lm, 3.000 K



828530507  
 828530531





07 Nickel matt · nickel mat  
31 weiß matt · white mat



# CAYMAN

Metall, weiß · metal, white ·  
 metale, blanc · metaal, wit · metal, blanco · metallo, bianco ·  
 metal, alb · metalli, valkoinen · metal, biały · metal, beyaz



520



↔ 8,5 x 8,5 cm, ↗ 12,5 cm  
 incl. 1 x SMD-LED, 4,5 W  
 1 x 430 lm, 3.000 K



829270101



↔ 22 x 9 cm, ↑ 12,5 cm  
 incl. 2 x SMD-LED, 4,5 W  
 2 x 430 lm, 3.000 K



829210201



↔ 36 x 9 cm, ↑ 12,5 cm  
 incl. 3 x SMD-LED, 4,5 W  
 3 x 430 lm, 3.000 K



829210301



↔ 84 x 9 cm, ↑ 15 cm  
 incl. 4 x SMD-LED, 4,5 W  
 4 x 430 lm, 3.000 K



829210401



↔ 21 x 21 cm, ↑ 12,4 cm  
 incl. 4 x SMD-LED, 4,5 W  
 4 x 430 lm, 3.000 K



829230401





## CLAPTON

Aluminium gebürstet, chrom, Glas weiß gewischt ·  
 brushed aluminium, chrome, glass white brushed glass ·  
 aluminium balayé, chrome, verre blanc balayé ·  
 geborsteld aluminium, chroom, wit geborsteld glas ·  
 alluminio pulido, cromo, blanco pulido · alluminio  
 spazzolato, cromo, vetro bianco spazzolato · aluminii  
 lucios, crom, alb lucios · harjattu alumiini, kromi,  
 lasi harjattu valkoinen · aluminium szczotkowane, chrom,  
 szkło białe otarła · alüminyum, krom, beyaz cam

522



↑ 20 x 7 cm, √ 16 cm  
 incl. 1 x SMD-LED, 4,5 W  
 400 lm, 3.000 K



821470105



↔ 36 x 7 cm, ↑ 18,5 cm  
 incl. 2 x SMD-LED, 4,5 W  
 2 x 400 lm, 3.000 K



821470205



↔ 50 x 7 cm, ↑ 18,5 cm  
 incl. 3 x SMD-LED, 4,5 W  
 3 x 400 lm, 3.000 K



821410305

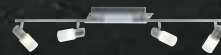

↔ 96,5 x 8 cm, ↑ 18,5 cm  
 incl. 4 x SMD-LED, 4,5 W  
 4 x 400 lm, 3.000 K



821410405



↔ max.150 x 8 cm, ↑ 24 cm  
 incl. 6 x SMD-LED, 4,5 W  
 6 x 400 lm, 3.000 K



821410605



↔ 31 x 22 cm, ↑ 18,5 cm  
incl. 4 x SMD-LED, 4,5 W  
4 x 400 lm, 3.000 K



821430405



↔ 70 x 50 cm, ↑ 23 cm  
incl. 5 x SMD-LED, 4,5 W  
5 x 400 lm, 3.000 K



621410505

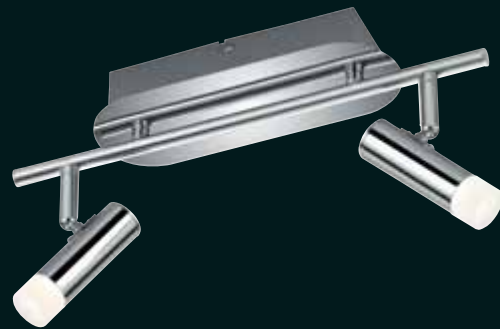
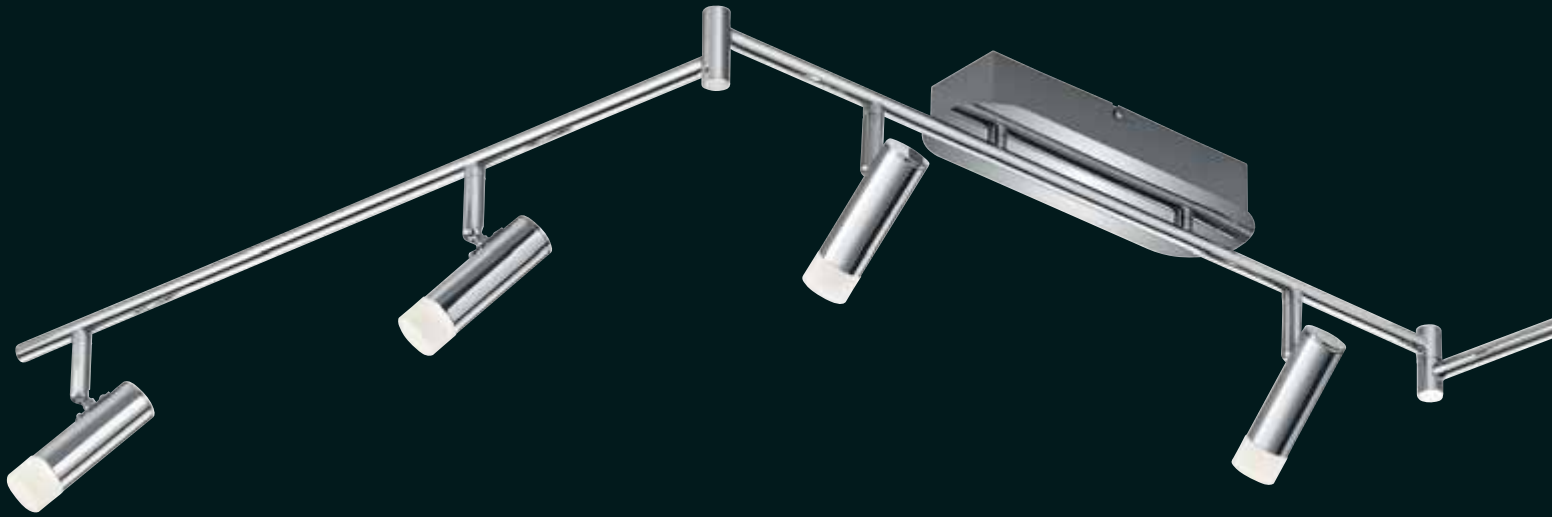

↑ 14 x 8 cm, ↗ 15 cm  
incl. 1 x SMD-LED, 4,5 W  
430 lm, 3.000 K



878670106



↔ 34 x 12 cm, ↑ 17,5 cm  
incl. 2 x SMD-LED, 4,5 W  
2 x 430 lm, 3.000 K



878610206



↔ 60 x 12 cm, ↑ 17,5 cm  
incl. 3 x SMD-LED, 4,5 W  
3 x 430 lm, 3.000 K



878610306



↔ 90 x 12 cm, ↑ 18 cm  
incl. 4 x SMD-LED, 4,5 W  
4 x 430 lm, 3.000 K



878610406



↔ 180 x 12 cm, ↑ 20 cm  
incl. 6 x SMD-LED, 4,5 W  
6 x 430 lm, 3.000 K



878610606

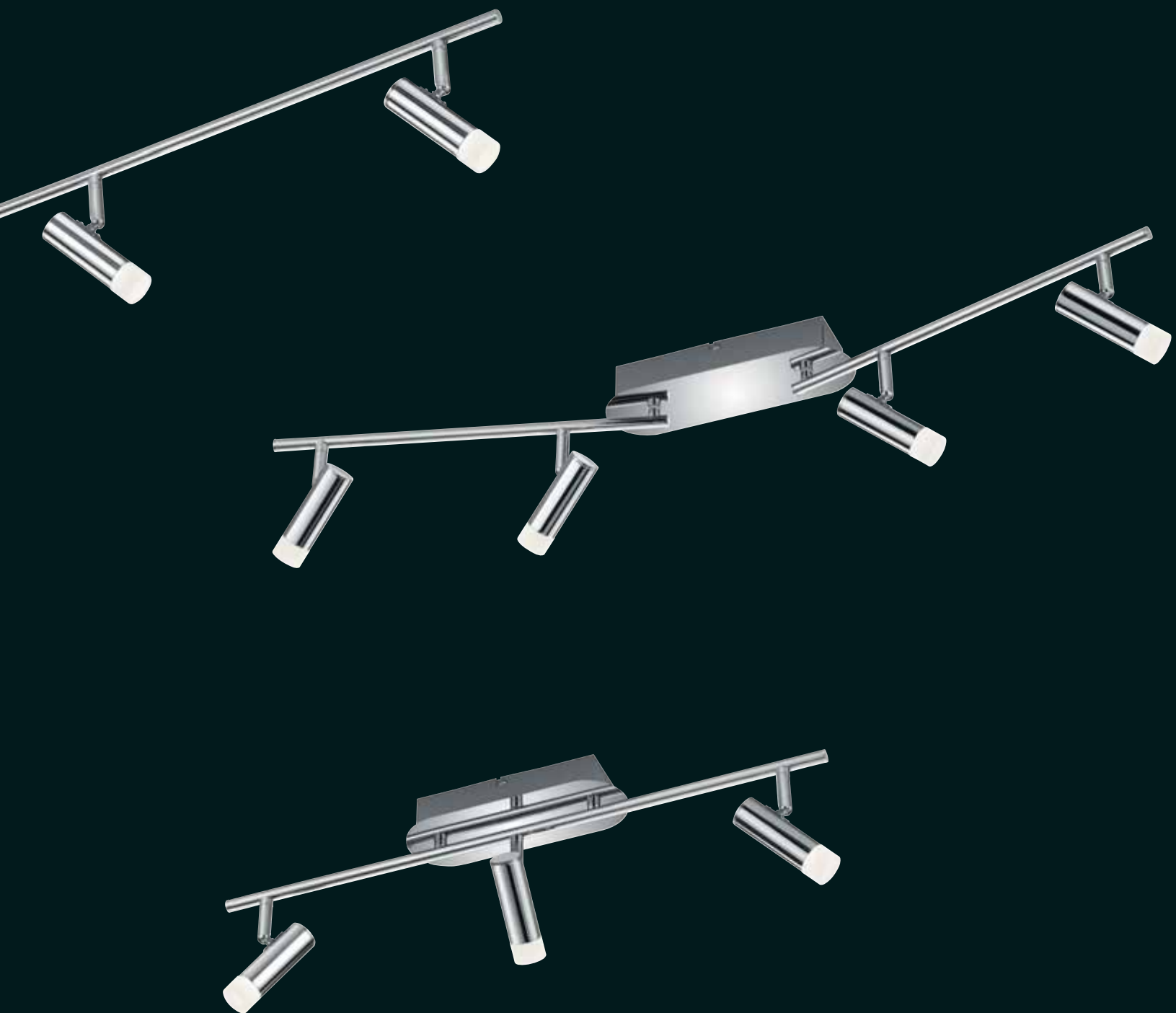

## ZIDANE

chrom, Acryl · chrome, acryl ·  
chrome, acryl · chroom, acryl · cromo, acrílico ·  
cromo, acrílico · crom, acrílic · kromi, akryyli ·  
chrom, akryl · krom, akrilik



# HAVANNA

Nickel matt · matt nickel ·  
 Nichel mat · Mat nikel · Nikiel mat · Harjattu teräs ·  
 Níquel mate · Nichel opaco · Nickel mat · Nikkel mat



526



↔ 10 x 18 cm, ↕ 16 cm  
 incl. 1 x SMD-LED, 6 W  
 1 x 470 lm, 3.000 K



829910107



↔ 26 x 20 cm, ↕ 16 cm  
 incl. 2 x SMD-LED, 6 W  
 2 x 470 lm, 3.000 K



829910207



↔ 34 x 20 cm, ↕ 16 cm  
 incl. 3 x SMD-LED, 6 W  
 3 x 470 lm, 3.000 K



829910307



↔ 42 x 20 cm, ↕ 16 cm  
 incl. 4 x SMD-LED, 6 W  
 4 x 470 lm, 3.000 K



829910407







## VISION

Nickel matt, Kunststoff · nickel mat, plastic ·  
 nickel mat, plastique · nikkell mat, kunststof · níquel mate, plástico ·  
 nichel opaco, plastica · nichel mat, plastic · harjattu teräs, muovi ·  
 nikiel mat, plastik · mat nikel, plastik

### LED SWITCHDIMMER



↔ 10 x 12 cm, ↗ 16,5 cm  
 incl. 1 x SMD-LED, 4,3 W  
 380 lm, 3.000 K



872670107



↔ 30 x 8 cm, ↗ 16,5 cm  
 incl. 2 x SMD-LED, 4,3 W  
 2 x 380 lm, 3.000 K



872670207



↔ 46 x 8 cm, ↗ 16,5 cm  
 incl. 3 x SMD-LED, 4,3 W  
 3 x 380 lm, 3.000 K



872670307



↔ 85,5 cm, ↓ 19 cm  
 incl. 4 x SMD-LED, 4,3 W  
 4 x 380 lm, 3.000 K



872610407



↔ 70 x 45,5 cm, ↓ 23 cm  
 incl. 5 x SMD-LED, 4,3 W  
 5 x 380 lm, 3.000 K



672610507





↑ 11 x 11 cm, ↗ 16 cm  
incl. 1 x SMD, 8 W  
730 lm, 3.000 K



**827890131**  
**827890132**

↔ 30 x 9 cm, ↗ 16 cm  
incl. 2 x SMD, 6 W  
2 x 550 lm, 3.000 K



**827890231**  
**827890232**

↔ 45 x 9 cm, ↗ 16 cm  
incl. 3 x SMD, 6 W  
3 x 550 lm, 3.000 K



**827890331**  
**827890332**

↔ 26 x 25 cm, ↑ 16 cm  
incl. 4 x SMD, 6 W  
4 x 550 lm, 3.000 K

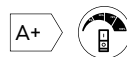

**827830431**  
**827830432**

↓ 154 cm, ↔ 28 cm  
incl. 3 x SMD, 4,7 W  
3 x 470 lm, 3.000 K

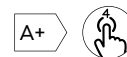

**427890331**  
**427890332**

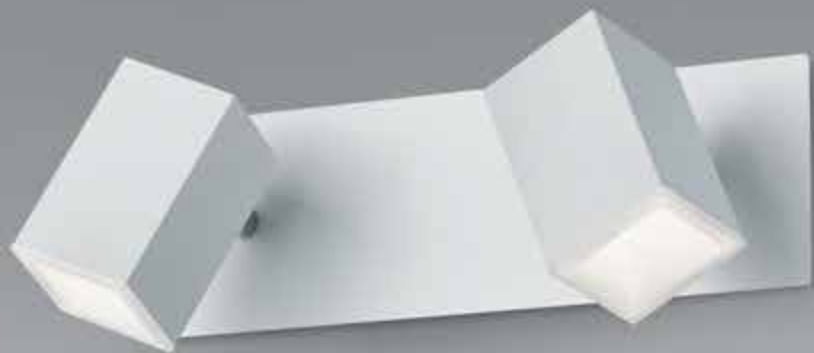

## LAGOS

Metall, Acryl · metal, acryl ·  
metale, acryl · metaal, acryl · metal, acrílico ·  
metallo, acrilico · metal, acrilic · metalli, akryyli ·  
metal, akryl · metal, akrilik

**LED SWITCHDIMMER**



- 31** weiß matt · white mat
- 32** schwarz matt · black mat

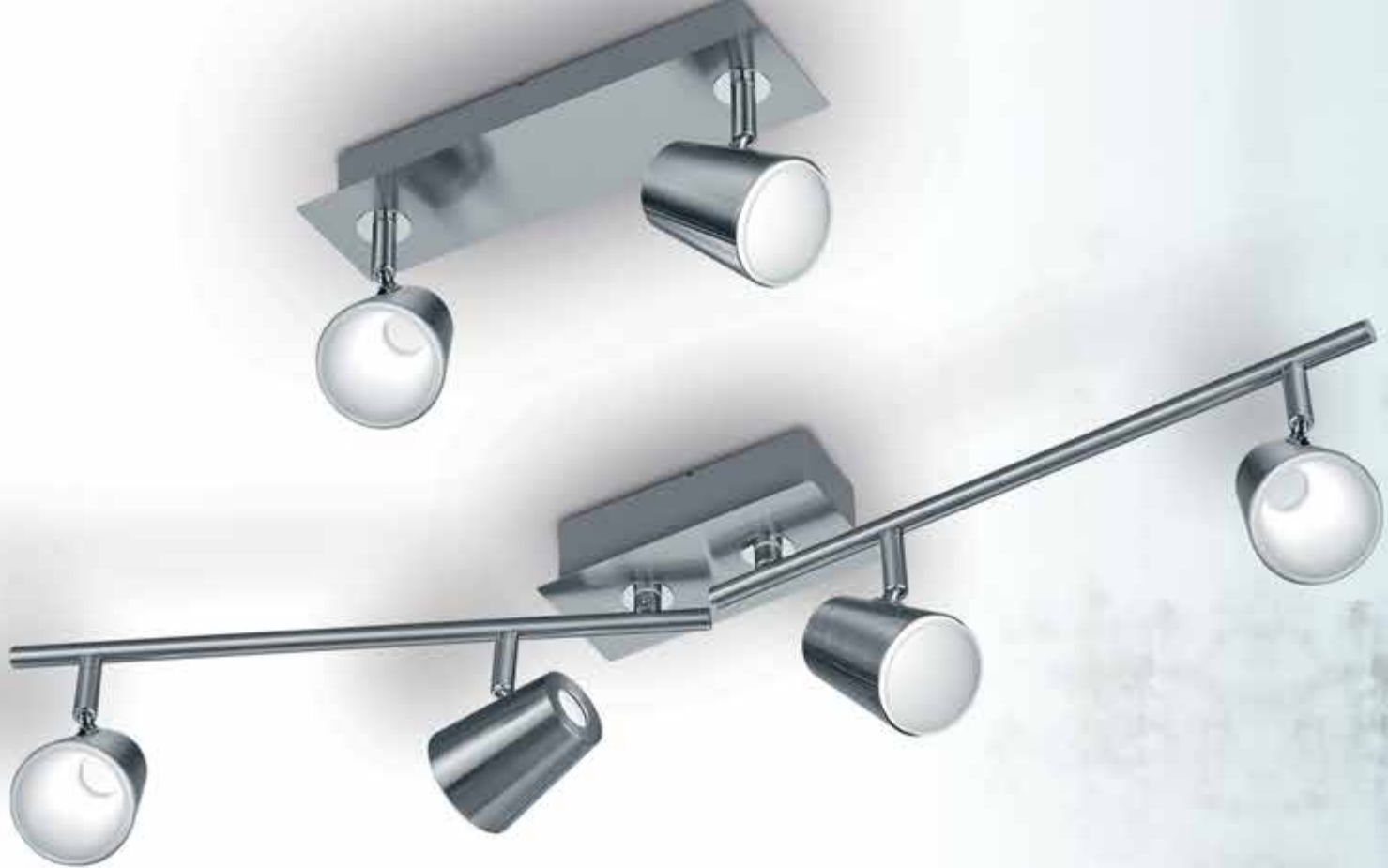

# NARCOS

Nickel matt · nickel mat ·  
 nickel mat · nikkell mat · níquel mate · nichel opaco ·  
 nichel mat · harjattu teräs · nikiel mat · mat nikel



↓ 12 x 7,5 cm, ↗ 16 cm  
 incl. SMD-LED, 6 W  
 550 lm, 3.000 K



**873170107**



↔ 28,5 x 9,5 cm, ↗ 16 cm  
 incl. 2 x SMD-LED, 6 W  
 2 x 550 lm, 3.000 K



**873170207**



↔ 45 x 9,5 cm, ↓ 16 cm  
 incl. 3 x SMD-LED, 6 W  
 3 x 550 lm, 3.000 K



**873110307**



↔ 81,5 x 8 cm, ↓ 20 cm  
 incl. 4 x SMD-LED, 6 W  
 4 x 550 lm, 3.000 K



**873110407**



↔ 177 x 10 cm, ↓ 23 cm  
 incl. 6 x SMD-LED, 6 W  
 6 x 550 lm, 3.000 K



**873110607**

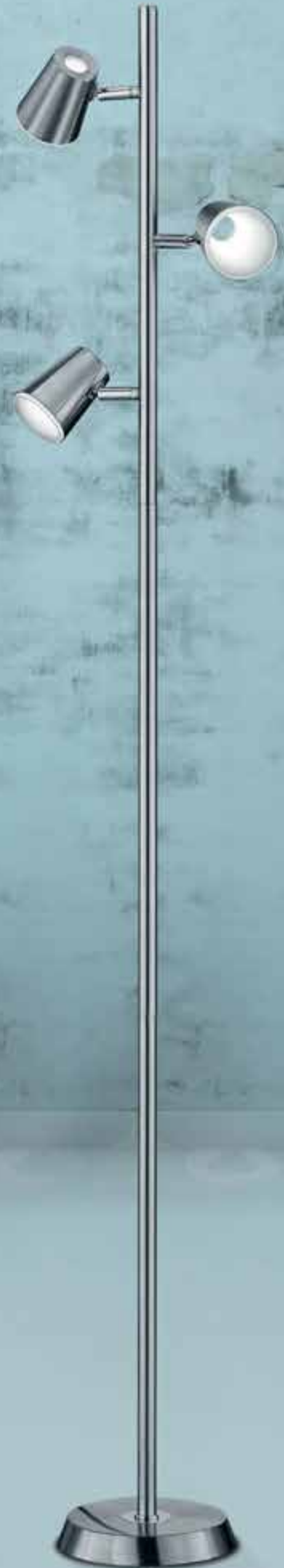

↑ 38 cm, ↗ 23 cm  
incl. SMD-LED, 4,7 W  
470 lm, 3.000 K



573190107



↑ 154 cm, ↔ 28 cm  
incl. 3 x SMD-LED, 4,7 W  
3 x 470 lm, 3.000 K



473190307



# NARCOS

weiß matt · white mat ·  
 blanc mat · wit mat · blanco mate · bianco opaco ·  
 alb mat · valkoinen teräs · biały mat · mat beyaz



↓ 12 x 7,5 cm, ↗ 16 cm  
 incl. SMD-LED, 6 W  
 550 lm, 3.000 K



873170131



↔ 28,5 x 9,5 cm, ↗ 16 cm  
 incl. 2 x SMD-LED, 6 W  
 2 x 550 lm, 3.000 K



873170231



↔ 45 x 9,5 cm, ↓ 16 cm  
 incl. 3 x SMD-LED, 6 W  
 3 x 550 lm, 3.000 K

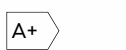

873110331



↔ 81,5 x 8 cm, ↓ 20 cm  
 incl. 4 x SMD-LED, 6 W  
 4 x 550 lm, 3.000 K



873110431



↔ 177 x 10 cm, ↓ 23 cm  
 incl. 6 x SMD-LED, 6 W  
 6 x 550 lm, 3.000 K

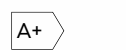

873110631





↑ 154 cm, ↔ 28 cm  
incl. 3 x SMD-LED, 4,7 W  
3 x 470 lm, 3.000 K



473190331



↑ 38 cm, ↗ 23 cm  
incl. SMD-LED, 4,7 W  
470 lm, 3.000 K



573190131



## SHARK

Nickel matt, Acryl · nickel mat, acryl ·  
 nickel mat, acryl · nikkell mat, acryl · níquel mate, acrílico · nichel opaco, acrílico ·  
 nichel mat, acrílico · harjattu teräs, akryyli · nikiel mat, akryl · mat nikel, akrilik



↔ 8,2 x 8,5 cm, ↗ 13 cm  
 incl. 1 x SMD-LED, 3,5 W  
 340 lm, 3.000 K

A++

879310107



↔ 34 cm, ↑ 16 cm  
 incl. 2 x SMD-LED, 3,5 W  
 2 x 340 lm, 3.000 K

A++

879310207



∅ 25 cm, ↑ 15,5 cm  
 incl. 3 x SMD-LED, 3,5 W  
 3 x 340 lm, 3.000 K

A++

879390307



↔ 72 cm, ↑ 15,5 cm  
 incl. 4 x SMD-LED, 3,5 W  
 4 x 340 lm, 3.000 K

A++

879310407



↔ 80,5 cm, ↑ 17,5 cm  
 incl. 6 x SMD-LED, 3,5 W  
 6 x 340 lm, 3.000 K

A++

879310607



↑ 40 cm  
incl. 2 x SMD-LED, 3,5 W  
2 x 340 lm, 3.000 K



579310207



↑ 150 cm  
incl. 3 x SMD-LED, 3,5 W  
3 x 340 lm, 3.000 K

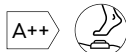

479310307



## PONTIUS

chrom, Acryl · chrome, acryl ·  
 chrome, acryl · chroom, acryl · cromo, acrílico · cromo, acrilico · crom, acrilic ·  
 kromi, akryyli · chrom, akryl · krom, akrilik



## PILATUS

chrom, Acryl · chrome, acryl ·  
 chrome, acryl · chroom, acryl · cromo, acrílico · cromo, acrilico · crom, acrilic ·  
 kromi, akryyli · chrom, akryl · krom, akrilik



## SHARK

Nickel matt, Acryl · nickel mat, acryl ·  
 nickel mat, acryl · nikkell mat, acryl · níquel mate, acrílico · nichel opaco, acrilico ·  
 nichel mat, acrilic · harjattu teräs, akryyli · nikiel mat, akryl · mat nikel, akrilik



↔ max. 500 x 13,5 cm  
 incl. 5 x SMD-LED, 4,1 W  
 5 x 330 lm, 3.000 K

A+

775810506

↔ max. 500 x 13,5 cm  
 incl. 5 x SMD-LED, 3,8 W  
 5 x 350 lm, 3.000 K

A+

775910506

↔ max. 500 x 13,5 cm  
 incl. 5 x SMD-LED, 2,5 W  
 5 x 245 lm, 3.000 K

A++

779310507

# SHARK

Nickel matt, Acryl · nickel mat, acryl ·  
nickel mat, acryl · nikkell mat, acryl · níquel mate, acrílico ·  
nichel opaco, acrílico · nichel mat, acrylic · harjattu teräs, akryyli ·  
nikiel mat, akryl · mat nikel, akrilik



↔ 750 cm

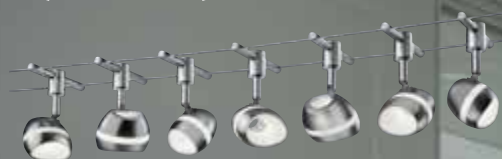

↔ max. 750 x 13,5 cm  
incl. 7 x SMD-LED, 2,5 W  
7 x 245 lm, 3.000 K

A++

779310707



540

## AVIGNON

chrom, Acryl · chrome, acryl ·  
chrome, acryl · chroom, acryl · cromo, acrílico ·  
cromo, acrilico · crom, acrilic · kromi, akryyli ·  
chrom, akryl · krom, akrilik

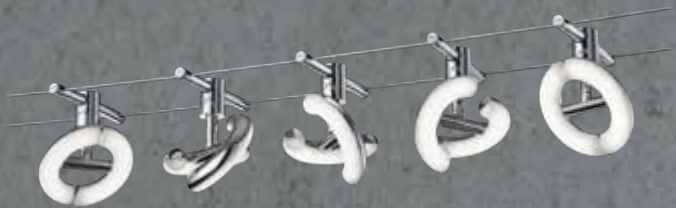

↔ max. 500 x 13 cm  
incl. 5 x SMD-LED, 4,1 W  
5 x 330 lm, 3.000 K

A+

777710506



## RENNES

chrom, Acryl · chrome, acryl ·  
 chrome, acryl · chroom, acryl · cromo, acrílico ·  
 cromo, acrilico · crom, acrilic · kromi, akryyli ·  
 chrom, akryl · krom, akrilik



## BASIC

titanfarbig · titan ·  
 titane · titaan · titán · titano ·  
 titaniu · titaani · tytanowy · titan

incl. LED GU5,3/MR16, 3 W  
 260 lm, 3.000 K  
 25.000 h



A+

916-30



## BALOUBET

chrom, Acryl · chrome, acryl ·  
 chrome, acryl · chroom, acryl · cromo, acrílico ·  
 cromo, acrilico · crom, acrilic · kromi, akryyli ·  
 chrom, akryl · krom, akrilik



↔ max. 500 x 11 cm  
 incl. 5 x SMD-LED, 3,8 W  
 5 x 350 lm, 3.000 K

A+

774110506



↔ max. 500 x 8 cm  
 incl. 5 x LED GU5,3/MR16, 3 W  
 5 x 260 lm, 3.000 K

A+

770010587



↔ max. 500 x 11 cm  
 incl. 5 x SMD-LED, 3,8 W  
 5 x 350 lm, 3.100 K

A+

778210506



## CHRIS

chrom, Acryl mit Kristalleffekt · chrome, broken glass optic ·  
 chrome, optique verre pilé · chroom, gebroken glas optiek ·  
 cromo, efecto cristal roto · cromo, effetto ottico vetro rotto ·  
 crom, aspect de sticla sparta · kromi, lasi efekti optiikka ·  
 chrom, optyczne rozbite szkło · krom, çatlatma cam



542



↔ 12,5 cm, ↗ 13,5 cm  
 incl. 1 x SMD-LED, 3,8 W  
 350 lm, 3.000 K

A+

878310106



↔ 33,5 cm, ↑ 15 cm  
 incl. 2 x SMD-LED, 3,8 W  
 2 x 350 lm, 3.000 K

A+

878310206



↔ 50 cm, ↑ 15 cm  
 incl. 3 x SMD-LED, 3,8 W  
 3 x 350 lm, 3.000 K

A+

878310306



↔ 75 cm, ↑ 15 cm  
 incl. 4 x SMD-LED, 3,8 W  
 4 x 350 lm, 3.000 K

A+

878310406



Ø 71 cm, ↑ 21 cm  
 incl. 6 x SMD-LED, 3,8 W  
 6 x 350 lm, 3.000 K

A+

678310606





↔ 57 x 34,5 cm, ↓ 20,5 cm  
incl. 5 x SMD-LED, 3,8 W  
5 x 350 lm, 3.000 K

A+

678310506



Ø 44 cm, ↓ 18 cm  
incl. 3 x SMD-LED, 3,8 W  
3 x 350 lm, 3.000 K

A+

678310306





Ø 8 cm, √ 15 cm  
incl. 1 x SMD-LED, 3,8 W  
350 lm, 3.100 K



828210106



↔ 33 cm, ↓ 16,5 cm  
incl. 2 x SMD-LED, 3,8 W  
2 x 350 lm, 3.100 K



828210206



↔ 50 cm, ↓ 16,5 cm  
incl. 3 x SMD-LED, 3,8 W  
3 x 350 lm, 3.100 K



828210306



↔ 83 cm, ↓ 16,5 cm  
incl. 4 x SMD-LED, 3,8 W  
4 x 350 lm, 3.100 K



828210406



↔ 180 cm, ↓ 19 cm  
incl. 6 x SMD-LED, 3,8 W  
6 x 350 lm, 3.100 K



828210606



↔ 75 x 45 cm, ↓ 25 cm  
incl. 5 x SMD-LED, 3,8 W  
5 x 350 lm, 3.100 K



628290506



# BALOUBET

chrom, Kunststoff/Metall · chrome, plastic/metal ·  
 chrome, plastique/metale · chrom, kunststof/metaal ·  
 cromo, plástico/metal · cromo, plastica/metallo ·  
 crom, plastic/metal · kromi, muovi/metalli ·  
 chrom, plastik/metal · krom, plastik/metal



↔ 75 cm, ↑ 79 - 180 cm  
 incl. 4 x SMD-LED, 3,8 W  
 4 x 350 lm, 3.100 K

↑ 35 cm, ↗ 22 cm  
 incl. 1 x SMD-LED, 3,8 W  
 350 lm, 3.100 K

↓ max. 44 cm  
 incl. 1 x SMD-LED, 3,8 W  
 350 lm, 3.100 K

↑ 125 cm, ↗ 45 cm  
 incl. 1 x SMD-LED, 3,8 W  
 350 lm, 3.100 K

↑ 125 cm, ↗ 45 cm  
 incl. 2 x SMD-LED, 3,8 W  
 2 x 350 lm, 3.100 K



328210406



528210106



828280106



428210106



428210206



## BOLOU

chrom, Kunststoff/Metall · chrome, plastic/metal ·  
 chrome, plastique/metale · chroom, kunststof/metaal ·  
 cromo, plástico/metall · cromo, plastica/metall · crom, plastic/metal ·  
 kromi, muovi/metalli · chrom, plastik/metal · krom, plastik/metal



Ø 8 cm, √ 13 cm  
 incl. 1 x SMD-LED, 3,8 W  
 350 lm, 3.000 K

A+

872810106



↔ 33,5 cm, ↑ 13 cm  
 incl. 2 x SMD-LED, 3,8 W  
 2 x 350 lm, 3.000 K

A+

872810206



↔ 75 cm, ↑ 13 cm  
 incl. 4 x SMD-LED, 3,8 W  
 4 x 350 lm, 3.000 K

A+

872810406



↔ 150 cm, ↑ 16 cm  
 incl. 6 x SMD-LED, 3,8 W  
 6 x 350 lm, 3.000 K

A+

872810606



Ø 25 cm, ↑ 12 cm  
 incl. 3 x SMD-LED, 3,8 W  
 3 x 350 lm, 3.000 K

A+

872830306



↔ 75 cm, ↑ 80 - 140 cm  
incl. 4 x SMD-LED, 3,8 W  
4 x 350 lm, 3.000 K

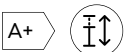

372810406



↔ 100 cm, ↑ 130 cm  
incl. 5 x SMD-LED, 3,8 W  
5 x 350 lm, 3.000 K



372810506



↓ max. 35 cm, Ø 11,5 cm  
incl. 1 x SMD-LED, 3,8 W  
350 lm, 3.000 K



572810106



Ø 8 cm, 13 cm  
incl. 1 x SMD-LED, 3,8 W  
350 lm, 3.000 K



872810101



↔ 33,5 cm, ↑ 13 cm  
incl. 2 x SMD-LED, 3,8 W  
2 x 350 lm, 3.000 K



872810201



↔ 75 cm, ↑ 13 cm  
incl. 4 x SMD-LED, 3,8 W  
4 x 350 lm, 3.000 K



872810401



↔ 150 cm, ↑ 16 cm  
incl. 6 x SMD-LED, 3,8 W  
6 x 350 lm, 3.000 K



872810601



## BOLOU

weiß, Kunststoff/Metall · white, plastic/metal ·  
blanc, plastique/métale · wit, kunststof/metaal ·  
blanco, plástico/metal · bianco, plastica/metallo ·  
alb, plastic/metal · valkoinen, muovi/metalli ·  
biały, plastik/metal · beyaz, plastik/metal



549



Ø 25 cm, ↑ 12 cm  
incl. 3 x SMD-LED, 3,8 W  
3 x 350 lm, 3.000 K

A+

872830301



↑ max. 35 cm, Ø 11,5 cm  
incl. 1 x SMD-LED, 3,8 W  
350 lm, 3.000 K

A+



572810101

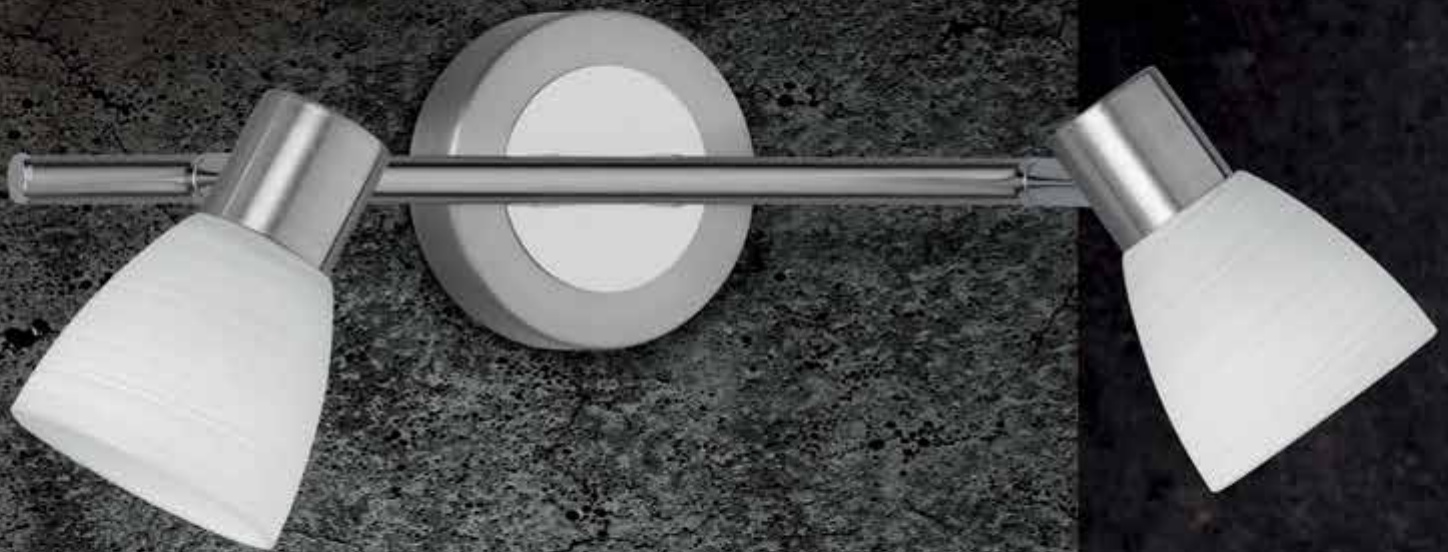

08

07



Ø 9 cm, ↗ 16 cm  
incl. 1 x LED G9, 3,5 W  
300 lm, 3.000 K

↔ 34 cm, ↑ 18 cm  
incl. 2 x LED G9, 3,5 W  
2 x 300 lm, 3.000 K

Ø 29,5 cm, ↑ 18 cm  
incl. 3 x LED G9, 3,5 W  
3 x 300 lm, 3.000 K

↔ 90 cm, ↑ 19 cm  
incl. 4 x LED G9, 3,5 W  
4 x 300 lm, 3.000 K

↔ 150 cm, ↑ 19 cm  
incl. 6 x LED G9, 3,5 W  
6 x 300 lm, 3.000 K



871570107  
871570108

871510207  
871510208

871590307  
871590308

871510407  
871510408

871510607  
871510608





## CARICO

Nickel matt oder Messing matt, Glas weiß gewischt ·  
 nickel mat or brass mat, glass white brushed glass · nickel mat ou laiton mat,  
 verre blanc balayé · nikkell mat of messing mat, wit geborsteld glas · níquel  
 mate o bronze mate, blanco pulido · nichel opaco o ottone satinato, vetro  
 bianco spazzolato · nichel mat sau bronz mat, alb lucios · harjattu teräs tai  
 mattamessinki, lasi harjattu valkoinen · nikiel mat lub mosiądz mat, szkło białe  
 otarła · mat nikel veya mat pirinç, beyaz cam



↔ 73 x 34,5 cm, ↑ 21,5 cm  
 incl. 5 x LED G9, 3,5 W  
 5 x 300 lm, 3.000 K



671510507

↔ 74,5 cm, ↑ 95 - 160 cm  
 incl. 4 x LED G9, 3,5 W  
 4 x 300 lm, 3.000 K



371510407  
 371510408



07 Nickel matt · nickel mat  
 08 Messing matt · brass mat



Ø 10 cm, 19 cm  
incl. 1 x LED E14, 5 W  
400 lm, 3.000 K

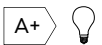

871010107  
871010108



↔ 33 cm, ↑ 19 cm  
incl. 2 x LED E14, 5 W  
2 x 400 lm, 3.000 K

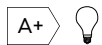

871010207  
871010208



↔ 55 cm, ↑ 19 cm  
incl. 3 x LED E14, 5 W  
3 x 400 lm, 3.000 K

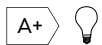

871010307  
871010308



Ø 45 cm, ↑ 23 cm  
incl. 3 x LED E14, 5 W  
3 x 400 lm, 3.000 K

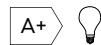

671010307



**07** Nickel matt · nickel mat  
**08** Messing matt · brass mat



## LEVISTO

Nickel matt oder Messing matt, Glas alabasterfarbig ·  
nickel mat or brass mat, alabaster-coloured glass · nickel mat ou laiton  
mat, verre couleur albâtre · nikkell mat of messing mat, albastkleurig glas ·  
níquel mate o bronce mate, vidrio de color alabastro · nichel opaco o  
ottone satinato, vetro colore alabastro · nichel mat sau bronz mat, sticla  
culoare alabastru · harjattu teräs tai mattamessinki, lasi alabasteri väri ·  
nikiel mat lub mosiądz mat, szkło alabaster kolor · mat nikel veya mat pirinç,  
cam kaymaktaşu rengi



incl.  
LED E14, 5 W  
400 lm, 3.000 K

A+

**983-60**



07

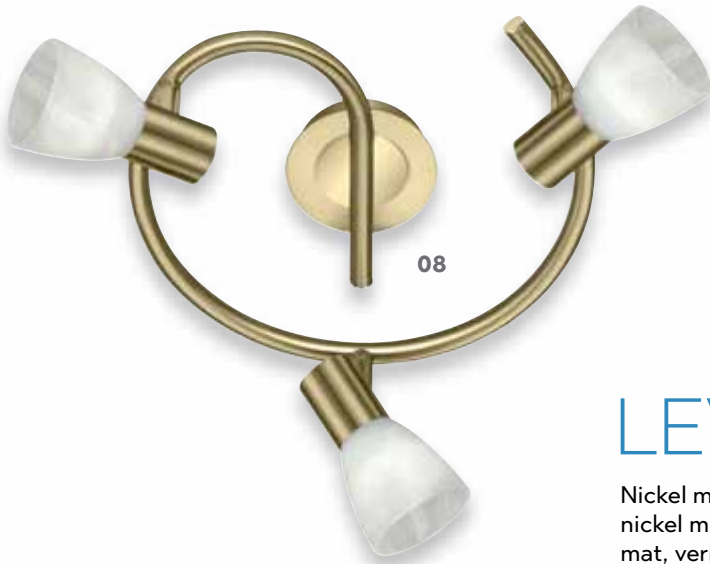

08

## LEVISTO

Nickel matt oder Messing matt, Glas alabasterfarbig ·  
 nickel mat or brass mat, alabaster-coloured glass · nickel mat ou laiton  
 mat, verre couleur albâtre · nikkell mat of messing mat, albastkleurig glas ·  
 níquel mate o bronce mate, vidrio de color alabastro · nichel opaco o  
 ottone satinato, vetro colore alabastro · nichel mat sau bronz mat, sticla  
 culoare alabastru · harjattu teräs tai mattamessinki, lasi alabasteri väri ·  
 nikiel mat lub mosiądz mat, szkło alabaster kolor · mat nikel veya mat pirinç,  
 cam kaymaktaşı rengi

incl.  
 LED E14, 5 W  
 400 lm, 3.000 K



A+

983-60



Ø 30 cm, ↑ 21 cm  
 incl. 3 x LED E14, 5 W  
 3 x 400 lm, 3.000 K

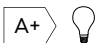

871090307  
 871090308



↔ 88 cm, ↑ 19 cm  
 incl. 4 x LED E14, 5 W  
 4 x 400 lm, 3.000 K



871010407  
 871010408



↔ 180 cm, ↑ 21 cm  
 incl. 6 x LED E14, 5 W  
 6 x 400 lm, 3.000 K

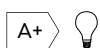

871010607  
 871010608

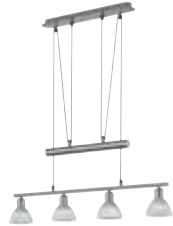

↔ 60,5 cm, ↓ 95 - 160 cm  
incl. 3 x LED E14, 5 W  
3 x 400 lm, 3.000 K

↔ 80,5 cm, ↓ 95 - 160 cm  
incl. 4 x LED E14, 5 W  
4 x 400 lm, 3.000 K



**371010307**  
**371010308**

**371010407**  
**371010408**

**07** Nickel matt · nickel mat  
**08** Messing matt · brass mat



## FREDDY

Nickel matt oder rostfarbig, Glas matt ·  
 nickel mat or rusty, mat glass ·  
 nickel mat ou rouille, verre mat · nikkell mat of roestkleur,  
 mat glas · níquel mate o óxido, vidrio mate · nichel  
 opaco o ruggine, vetro sabbaiato · nichel mat sau ruginiu,  
 sticla mata · harjattu teräs tai rustiikki, mattalasi ·  
 nikiel mat lub miedz, szkło matowane · mat nikel veyá pas,  
 mat cam

incl.  
 LED E14, 4 W  
 320 lm, 3.000 K



A+

983-40



↓ 13 x 10 cm, ↗ 19 cm  
 incl. 1 x LED E14, 4 W  
 320 lm, 3.000 K



824810107  
 824810128



↔ 30 cm, ↓ 20 cm  
 incl. 2 x LED E14, 4 W  
 2 x 320 lm, 3.000 K



824810207  
 824810228



↔ 45 cm, ↓ 20,5 cm  
 incl. 3 x LED E14, 4 W  
 3 x 320 lm, 3.000 K



824810307  
 824810328



↔ 60 cm, ↓ 20,5 cm  
 incl. 4 x LED E14, 4 W  
 4 x 320 lm, 3.000 K



824810407  
 824810428



↔ 150 cm, ↓ 23 cm  
 incl. 6 x LED E14, 4 W  
 6 x 320 lm, 3.000 K



824810607  
 824810628



Ø 52 cm, ↓ 19 cm  
 incl. 3 x LED E14, 4 W  
 3 x 320 lm, 3.000 K



624830307  
 624830328



↓ 40 cm, ↗ 28 cm  
incl. 1 x LED E14, 4 W  
320 lm, 3.000 K



524810107  
524810128



↓ 150 cm, ↗ 55 cm  
incl. 1 x LED E14, 4 W  
320 lm, 3.000 K



424810107  
424810128



↓ 125 cm, ↗ 55 cm  
incl. 2 x LED E14, 4 W  
2 x 320 lm, 3.000 K



424810207  
424810228



↔ 78 cm, ↑ 85 - 180 cm  
incl. 4 x LED E14, 4 W  
4 x 320 lm, 3.000 K



324810407  
324810428



07 Nickel matt · nickel mat  
28 rostfarbig antik · antique rust

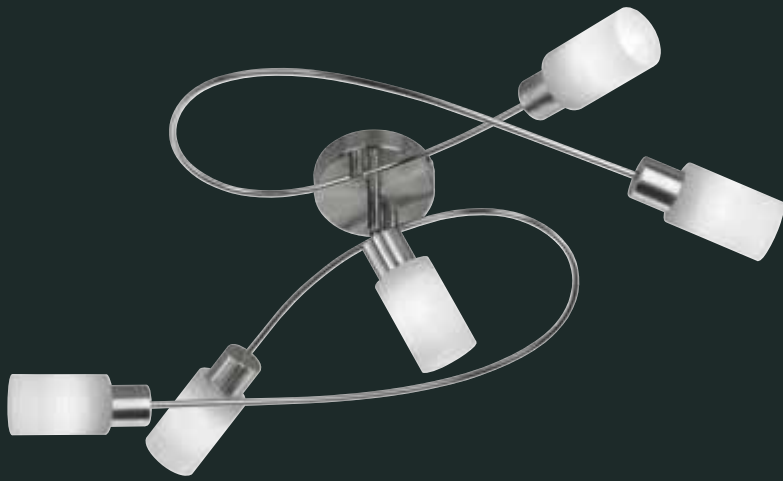

## JONES

Nickel matt, Glas weiß gewischt · nickel mat, glass white brushed glass ·  
 nickel mat, verre blanc balayé · nikkel mat, wit geborsteld glas ·  
 níquel mate, blanco pulido · nichel opaco, vetro bianco spazzolato ·  
 nichel mat, alb lucios · harjattu teräs, lasi harjattu valkoinen ·  
 nikiel mat, szkło białe otarła · mat nikel, beyaz cam

incl.  
 LED E14, 4 W  
 320 lm, 3.000 K



A+

989-40



Ø 8 cm, ↗ 18 cm  
 incl. 1 x LED E14, 4 W  
 320 lm, 3.000 K



871410107



↔ 30 cm, ↑ 18 cm  
 incl. 2 x LED E14, 4 W  
 2 x 320 lm, 3.000 K



871410207



↔ 44 cm, ↑ 18 cm  
 incl. 3 x LED E14, 4 W  
 3 x 320 lm, 3.000 K



871410307



↔ 62 cm, ↑ 18 cm  
 incl. 4 x LED E14, 4 W  
 4 x 320 lm, 3.000 K



871410407



↔ 150 cm, ↑ 18 cm  
 incl. 6 x LED E14, 4 W  
 6 x 320 lm, 3.000 K



871410607



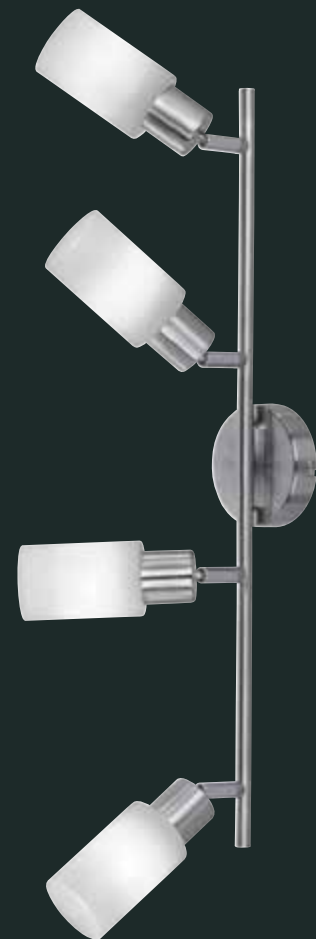
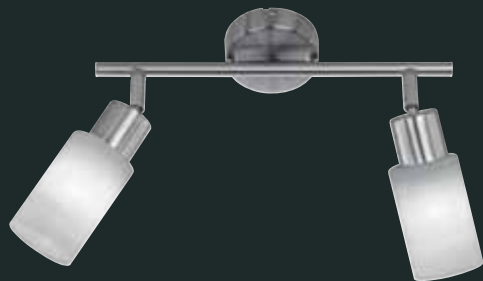

↔ 80 x 48 cm, ↑ 18 cm  
incl. 5 x LED E14, 4 W  
5 x 320 lm, 3.000 K

↔ 70 cm, ↑ 77 - 160 cm  
incl. 4 x LED E14, 4 W  
4 x 320 lm, 3.000 K



671410507



371410407



↔ 10 x 15 cm, ↗ 18 cm  
excl. 1 x GU10, max. 42 W

↔ 23 x 10 cm, ↑ 18 cm  
excl. 2 x GU10, max. 42 W

↔ 35 x 10 cm, ↑ 18 cm  
excl. 3 x GU10, max. 42 W

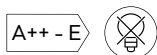
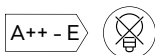
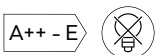

802500178

802500278

802500378



## CONCRETE

Beton, grau · concrete, grey ·  
béton, gris · beton, grijs · hormigón, gris · cemento, grigio · beton, gri · betoni,  
harmaa · beton, popielaty · beton, gri

Empfohlen:  
recommended: LED GU10, 5 W  
400 lm, 3.000 K



**956-55**



↔ 23 x 23 cm, ↑ 18 cm  
excl. 4 x GU10, max. 42 W

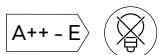

**802530478**



↑ 38 cm, ↔ 24 cm  
excl. 1 x GU10, max. 42 W



**512500178**



↑ 160 cm, ↔ 34 cm  
excl. 3 x GU10, max. 42 W



**402500378**



↔ 10 x 10 cm, ↗ 14 cm  
excl. 1 x GU10, max. 25 W

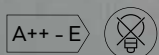

802600107



↔ 26 x 10 cm, ↓ 14 cm  
excl. 2 x GU10, max. 25 W

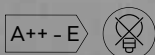

802600207



↔ 45 x 10 cm, ↓ 14 cm  
excl. 3 x GU10, max. 25 W

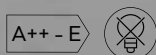

802600307



↔ 64 x 10 cm, ↓ 14 cm  
excl. 4 x GU10, max. 25 W

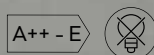

802600407



## DAXTER

Nickel matt · nickel mat ·  
nickel mat · nikkell mat · níquel mate · nichel opaco ·  
nichel mat · harjattu teräs · nikiel mat · mat nikel

Empfohlen:

recommended: LED GU10, 5 W  
400 lm, 3.000 K



**956-55**





01



↑ 12 x 12 cm, ↗ 15 cm  
excl. 1 x GU10, max. 35 W



802400101  
802400107



↔ 30 x 9 cm, ↓ 15 cm  
excl. 2 x GU10, max. 35 W



802400201  
802400207



↔ 48 x 9 cm, ↓ 15 cm  
excl. 3 x GU10, max. 35 W



802400301  
802400307



↔ 24 x 24 cm, ↓ 15 cm  
excl. 4 x GU10, max. 35 W



802430401  
802430407



01 weiß · white  
07 Nickel matt · nickel mat



## MARLEY

Nickel matt oder weiß · nickel mat or white ·  
nickel mat ou blanc · nikkell mat of wit ·  
níquel mate o blanco · nichel opaco o bianco ·  
nichel mat sau alb · harjattu teräs tai valkoinen ·  
nikiel mat lub biały · mat nikel veya beyaz

Empfohlen:

recommended: LED GU10, 5 W  
400 lm, 3.000 K



A+

955-50





↓ 10,6 x 6 cm, ↗ 13 cm  
excl. 1 x GU10, max. 28 W

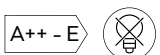

803000107



↓ 37 x 11 cm, ↗ 22 cm  
excl. 1 x GU10, max. 28 W



803080107



↔ 32 x 5 cm, ↓ 13 cm  
excl. 2 x GU10, max. 28 W

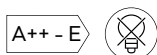

803000207



↔ 54 x 5 cm, ↓ 13 cm  
excl. 3 x GU10, max. 28 W

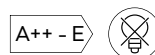

803000307



↔ 80 x 10 cm, ↓ 20 cm  
excl. 4 x GU10, max. 28 W



803000407





# MICHAEL

Nickel matt · nickel mat ·  
 nickel mat · nikkell mat · níquel mate ·  
 nichel opaco · nichel mat · harjattu teräs ·  
 nikiel mat · mat nikel

Empfohlen:  
 recommended: LED GU10, 5 W  
 400 lm, 3.000 K



**956-55**



↔ 180 x 10 cm, ↓ 18 cm  
 excl. 6 x GU10, max. 28 W

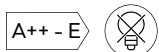

**803000607**



Ø 25,5 cm, ↓ 15 cm  
 excl. 3 x GU10, max. 28 W

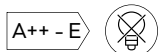

**803090307**



## BOWIE

chrom · chrome ·  
chrome · chroom · cromo ·  
cromo · crom · kromi · chrom · krom

Empfohlen:  
recommended: LED GU10, 5 W  
400 lm, 3.000 K



A+

955-50



↓ 14 x 8 cm, ↗ 15 cm  
excl. 1 x GU10, max. 25 W



818070106



↔ 40 x 8 cm, ↓ 18 cm  
excl. 2 x GU10, max. 25 W

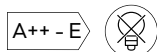

818000206



↔ 55 x 8 cm, ↓ 18 cm  
excl. 3 x GU10, max. 25 W

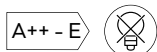

818000306



↔ 80 x 8 cm, ↓ 18 cm  
excl. 4 x GU10, max. 25 W

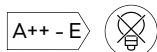

818000406



↔ 130 x 8 cm, ↓ 18 cm  
excl. 6 x GU10, max. 25 W

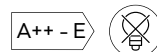

818000606



# MORRISON

chrom, Glas opal · chrome, opal glass ·  
 chrome, verre opale · chrom, opaal glas · cromo, vidrio opal ·  
 cromo, vetro opale · crom, sticla opala · kromi, opaalilasi ·  
 chrom, szkło opal · krom, opal cam

Empfohlen:

recommended: LED E14, 4 W  
 320 lm, 3.000 K



A+

989-40



Ø 10 cm, √ 15 cm  
 excl. 1 x E14, max. 40 W

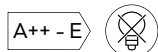

801000106



↔ 35 cm, ↓ 17 cm  
 excl. 2 x E14, max. 40 W

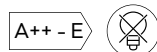

801000206



↔ 49 cm, ↓ 17 cm  
 excl. 3 x E14, max. 40 W

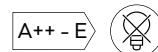

801000306



↔ 92 cm, ↓ 17 cm  
 excl. 4 x E14, max. 40 W

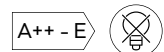

801000406



↔ 9,5 x 12 cm, ↗ 17 cm  
excl. 1 x E14, max. 40 W



800300132



↔ 36,5 cm, ↓ 19 cm  
excl. 2 x E14, max. 40 W



800300232



↔ 69,5 cm, ↓ 19 cm  
excl. 4 x E14, max. 40 W



800300432



∅ 28,5 cm, ↓ 19 cm  
excl. 3 x E14, max. 40 W



800300332



## HOUSTON

Metall, schwarz/goldfarbig · metal, black/gold ·  
metale, noir/ro · metaal, zwart/goud · metal, negro/oro ·  
metallo, nero/oro · metal, negru/aur · metalli, musta/kultaa ·  
metal, czarny/złota · metal, siyah/altın

Empfohlen:

recommended: Filament LED E14, 4 W  
400 lm, 3.000 K



A++

**989-400**



# Einbauleuchten

Recessed spots  
Spots encastrés  
Inbouwspots  
Focos empotrables  
Faretti incasso  
Spoturi incastrate  
Upotetut spotit  
Oprawy wbudowane



31



07

3er Set/3 pc.



↔ 8 x 8 cm, ↓ 7 cm  
excl. 3 x GU10, max. 15 W

∅ 8,3 cm, ↓ 7 cm  
excl. 3 x GU10, max. 15 W



650000306  
650000307  
650000331

650100306  
650100307  
650100331

06 chrom · chrome  
07 Nickel matt · nickel mat  
31 weiß matt · white mat



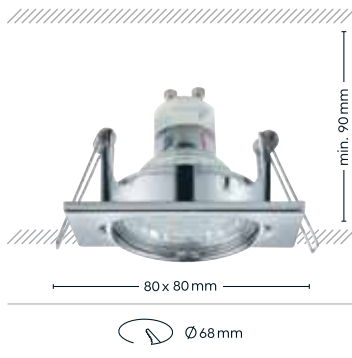

# JURA

Metall · metal ·  
metale · metaal · metal · metallo ·  
metal · metalli · metal · metal

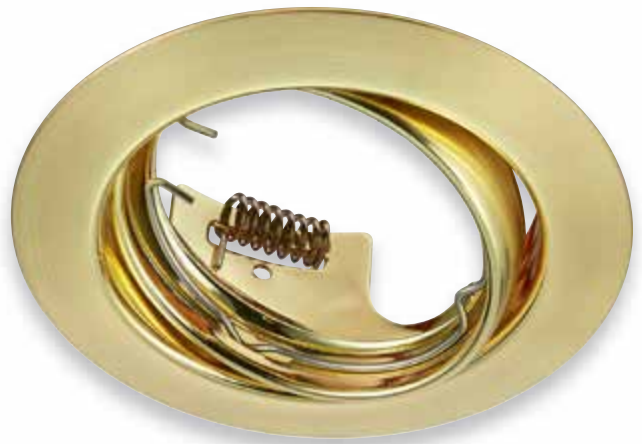

08

Empfohlen:

recommended: LED GU10, 3 W  
250 lm, 3.000 K,  $\approx 110^\circ$



956-30

LED GU10, 5 W  
400 lm, 3.000 K,  $\approx 36^\circ$



956-5736

LED GU10, 5 W  
400 lm, 3.000 K,  $\approx 36^\circ$



956-5936



$\leftrightarrow 8 \times 8 \text{ cm}$ ,  $\updownarrow 7 \text{ cm}$   
excl. 1 x GU10, max. 15 W



650000106  
650000107  
650000108  
650000131  
650000132



$\varnothing 8,3 \text{ cm}$ ,  $\updownarrow 7 \text{ cm}$   
excl. 1 x GU10, max. 15 W



650100106  
650100107  
650100108  
650100131  
650100132



06 chrom · chrome  
07 Nickel matt · nickel mat  
08 Messing matt · brass mat  
31 weiß matt · white mat  
32 schwarz matt · black mat



07



31

3er Set/3 pc.



↔ 8 x 8 cm, ↑ 3,4 cm  
incl. 3 x SMD, 5 W  
3 x 370 lm, 3.000 K



650210306  
650210307  
650210331

∅ 8,2 cm, ↑ 3,4 cm  
incl. 3 x SMD, 5 W  
3 x 370 lm, 3.000 K



650310306  
650310307  
650310331



06 chrom · chrome  
07 Nickel matt · nickel mat  
31 weiß matt · white mat

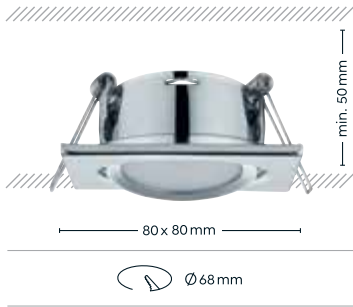

## RILA

Metall · metal ·  
 metale · metaal · metal · metallo ·  
 metal · metalli · metal · metal



07



↔ 8 x 8 cm, ↑ 3,4 cm  
 incl. 1 x SMD, 5 W  
 370 lm, 3.000 K



650210106  
 650210107  
 650210131



Ø 8,2 cm, ↑ 3,4 cm  
 incl. 1 x SMD, 5 W  
 370 lm, 3.000 K



650310106  
 650310107  
 650310131



**06** chrom · chrome  
**07** Nickel matt · nickel mat  
**31** weiß matt · white mat



06



07

3er Set/3 pc.



↔ 8,5 x 8,5 cm, ↓ 5,4 cm  
incl. 3 x SMD, 5,5 W  
3 x 345 lm, 3.000 K



650410306  
650410307  
650410331

∅ 8,5 cm, ↓ 5,4 cm  
incl. 3 x SMD, 5,5 W  
3 x 345 lm, 3.000 K



650510306  
650510307  
650510331



**06** chrom · chrome  
**07** Nickel matt · nickel mat  
**31** weiß matt · white mat

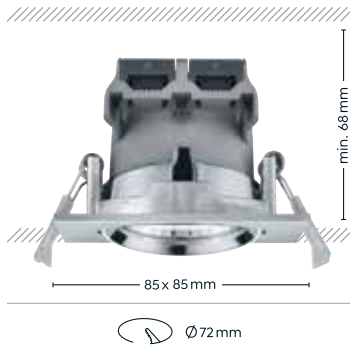

# PAMIR

Metall · metal ·  
 metale · metaal · metal · metallo ·  
 metal · metalli · metal · metal



31



↔ 8,5 x 8,5 cm, ↑ 5,4 cm  
 incl. 1 x SMD, 5,5 W  
 345 lm, 3.000 K



650410106  
 650410107  
 650410131  
 650410132

Ø 8,5 cm, ↑ 5,4 cm  
 incl. 1 x SMD, 5,5 W  
 345 lm, 3.000 K



650510106  
 650510107  
 650510131  
 650510132



06 chrom · chrome  
 07 Nickel matt · nickel mat  
 31 weiß matt · white mat  
 32 schwarz matt · black mat



3er Set/3 pc.



↔ 8,5 x 8,5 cm, ↓ 5,4 cm  
incl. 3 x SMD, 5,5 W  
3 x 345 lm, 3.000 K

∅ 8,5 cm, ↓ 5,4 cm  
incl. 3 x SMD, 5,5 W  
3 x 345 lm, 3.000 K



650610306  
650610307  
650610331

650710306  
650710307  
650710331

**06** chrom · chrome  
**07** Nickel matt · nickel mat  
**31** weiß matt · white mat

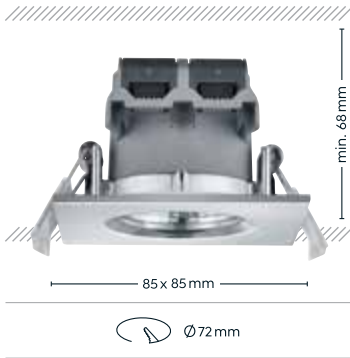

# ZAGROS

Metall · metal ·  
metale · metaal · metal · metallo ·  
metal · metalli · metal · metal



31



↔ 8,5 x 8,5 cm, ↑ 5,4 cm  
incl. 1 x SMD, 5,5 W  
345 lm, 3.000 K



650610106  
650610107  
650610131

Ø 8,5 cm, ↑ 5,4 cm  
incl. 1 x SMD, 5,5 W  
345 lm, 3.000 K



650710106  
650710107  
650710131



**06** chrom · chrome  
**07** Nickel matt · nickel mat  
**31** weiß matt · white mat







# PINDOS

Metall · metal ·  
 metale · metaal · metal · metallo ·  
 metal · metalli · metal · metal



Ø 22,5 cm, ↑ 2,8 cm  
 incl. SMD-LED, 18 W  
 1.500 lm, 3.000 K



650910106  
 650910107  
 650910131



**06** chrom · chrome  
**07** Nickel matt · nickel mat  
**31** weiß matt · white mat



# Badezimmerleuchten

Bathroom lighting  
Éclairage salle de bains  
Badkamer verlichting  
Iluminación de cuarto de baño  
Illuminazione per bagno  
Illuminat baie  
Kylpyhuone valaistus  
Oświetlenie łazienkowe  
Banyo aydınlatma



## NEVIO

chrom, Glas matt · chrome, mat glass ·  
 chrome, verre mat · chroom, mat glas ·  
 cromo, vidrio mate · cromo, vetro sabbiato ·  
 crom, sticla mata · kromi, mattalasi ·  
 chrom, szkło matowane · krom, mat cam

IP44



↑ 14,5 cm, ↔ 7 cm, ↗ 13 cm  
 incl. 1 x SMD-LED, 3,2 W  
 300 lm, 3.000 K



282310106



↑ 21,5 cm, ↔ 7 cm, ↗ 13 cm  
 incl. 2 x SMD-LED, 3,2 W  
 2 x 300 lm, 3.000 K



282310206



Ø 30 cm, ↑ 14,5 cm  
 incl. 3 x SMD-LED, 4,5 W  
 3 x 430 lm, 3.000 K



682310306



## BRIAN

chrom, Acryl · chrome, acryl ·  
chrome, acryl · chroom, acryl · cromo, acrílico ·  
cromo, acrílico · crom, acrilic · kromi, akryyli ·  
chrom, akryl · krom, akrilik

IP44

587



↑ 10 cm, ↔ 8,5 cm, ↗ 12,5 cm  
incl. 1 x SMD-LED, 3,6 W  
260 lm, 3.000 K

A+ IP44

282710106

↑ 16,5 cm, ↔ 8,5 cm, ↗ 12,5 cm  
incl. 2 x SMD-LED, 2,8 W  
2 x 180 lm, 3.000 K

A+ IP44

282710206

H<sub>2</sub>O



## BOLSA

chrom, Acryl · chrome, acryl ·  
chrome, acryl · chroom, acryl · cromo, acrílico ·  
cromo, acrilico · crom, acrilic · kromi, akryyli ·  
chrom, akryl · krom, akrilik



588



↑ 19 cm, ↔ 7 cm, ↗ 12 cm  
incl. 1 x SMD-LED, 3,2 W  
300 lm, 3.000 K



282410106



↑ 30 cm, ↔ 7 cm, ↗ 12 cm  
incl. 2 x SMD-LED, 3,2 W  
2 x 300 lm, 3.000 K



282410206



Ø 41,5 cm, ↑ 16,5 cm  
incl. 5 x SMD-LED, 3,2 W  
5 x 300 lm, 3.000 K



682410506

# HELEN

chrom, Acryl · chrome, acryl ·  
chrome, acryl · chroom, acryl · cromo, acrílico ·  
cromo, acrílico · crom, acrilic · kromi, akryyli ·  
chrom, akryl · krom, akrilik

589



↔ 18 cm, ↑ 6 cm, ↗ 9,5 cm  
incl. 1 x SMD-LED, 4,5 W  
430 lm, 3.000 K



282510106



↔ 43 cm, ↑ 6 cm, ↗ 9,5 cm  
incl. 2 x SMD-LED, 4,5 W  
2 x 430 lm, 3.000 K



282510206

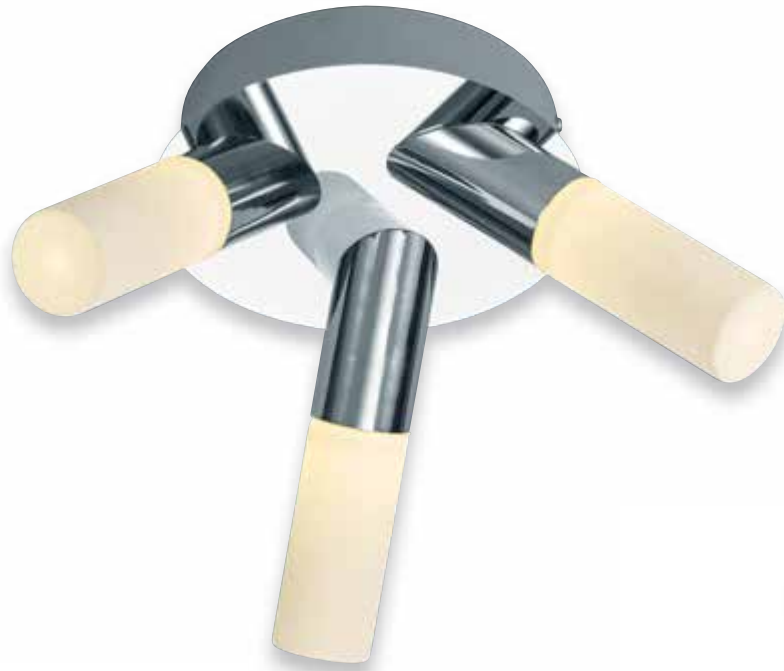

07



06



## DYLAN

chrom oder Nickel matt, Glas matt · chrome or nickel mat, mat glass ·  
 chrome ou nickel mat, verre mat · chroom of nikkell mat, mat glas ·  
 cromo o níquel mate, vidrio mate · cromo o nichel opaco, vetro sabbiato ·  
 crom sau nichel mat, sticla mata · kromi tai harjattu teräs, mattalasi ·  
 chrom lub nikiel mat, szkło matowane · krom veyá mat nikel, mat cam

IP44



↓ 20 x 11 cm, ↗ 12,5 cm  
 incl. 1 x SMD, 4,3 W  
 430 lm, 3.000 K



283370106  
 283370107



↓ 34,5 x 13 cm, ↗ 9 cm  
 incl. 2 x SMD, 4,3 W  
 2 x 430 lm, 3.000 K



283370206  
 283370207



Ø 37 cm, ↓ 18,5 cm  
 incl. 3 x SMD, 4,3 W  
 3 x 430 lm, 3.000 K



683310306  
 683310307



06 chrom · chrome  
 07 Nickel matt · nickel mat





## RAY

chrom, Acryl · chrome, acryl ·  
chrome, acryl · chroom, acryl · cromo, acrílico · cromo, acrílico ·  
crom, acrilic · kromi, akryyli · chrom, akryl · krom, akrilik

IP44

591



↑ 8,3 x 5,2 cm, ↗ 8 cm  
incl. 1 x SMD-LED, 4 W  
340 lm, 3.000 K



283110106



↑ 16,6 x 5,2 cm, ↗ 8 cm  
incl. 2 x SMD-LED, 4 W  
2 x 340 lm, 3.000 K



283110206



07

## BUTTELLO

chrom oder Nickel matt · chrome or nickel mat ·  
 chrome ou nickel mat · chroom of nikkell mat ·  
 cromo o níquel mate · cromo o nichel opaco ·  
 crom sau nichel mat · kromi tai harjattu teräs ·  
 chrom lub nikiel mat · krom veyá mat nikel

IP44



06



06

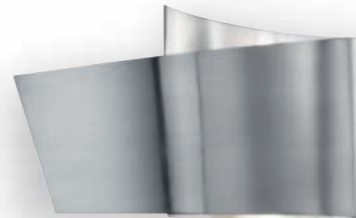

07

## FLESSO

chrom oder Nickel matt · chrome or nickel mat ·  
 chrome ou nickel mat · chroom of nikkell mat · cromo o níquel mate ·  
 cromo o nichel opaco · crom sau nichel mat · kromi tai harjattu teräs ·  
 chrom lub nikiel mat · krom veyá mat nikel

IP44



↔ 50 cm, ↑ 5 cm, √ 8,5 cm  
 incl. 2 x SMD-LED, 6 W  
 2 x 600 lm, 3.000 K



281670206  
 281670207



↔ 20 x 12 cm, √ 9,5 cm  
 incl. 1 x SMD-LED, 2,3 W  
 230 lm, 3.000 K



282210106  
 282210107



06 chrom · chrome  
 07 Nickel mat · nickel mat

# VIEW

chrom · chrome · chrome · chrome · chroom · cromo · cromo · crom · kromi · chrom · krom

IP44

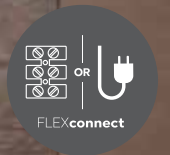

Seite/page 629

593



Ø 22 cm, ↗ max. 36 cm  
incl. SMD-LED, 3 W  
280 lm, 3.000 K

A+

IP44



282990106



↑ 20 x 20 cm, ↗ max. 36 cm  
incl. SMD-LED, 3 W  
280 lm, 3.000 K

A+

IP44



283090106

H<sub>2</sub>O



## NILO

chrom, Acryl · chrome, acryl ·  
chrome, acryl · chroom, acryl · cromo, acrílico ·  
cromo, acrilico · crom, acrilic · kromi, akryyli ·  
chrom, akryl · krom, akrilik

IP44



## KOLIAN

chrom, Acryl · chrome, acryl ·  
chrome, acryl · chroom, acryl · cromo, acrílico ·  
cromo, acrilico · crom, acrilic · kromi, akryyli ·  
chrom, akryl · krom, akrilik



IP44



594



↔ 88 x 7,5 cm, ↗ 2,5 cm  
incl. SMD-LED, 9 W  
900 lm, 3.000 K

↔ 120 x 7 cm, ↗ 2,5 cm  
incl. SMD-LED, 12 W  
1.200 lm, 3.000 K

↔ 44 x 6 cm, ↗ 9 cm  
incl. SMD-LED, 6 W  
600 lm, 3.000 K

↔ 64 x 6 cm, ↗ 9 cm  
incl. SMD-LED, 9 W  
970 lm, 3.000 K



281770906



281771206



281570606



281570906

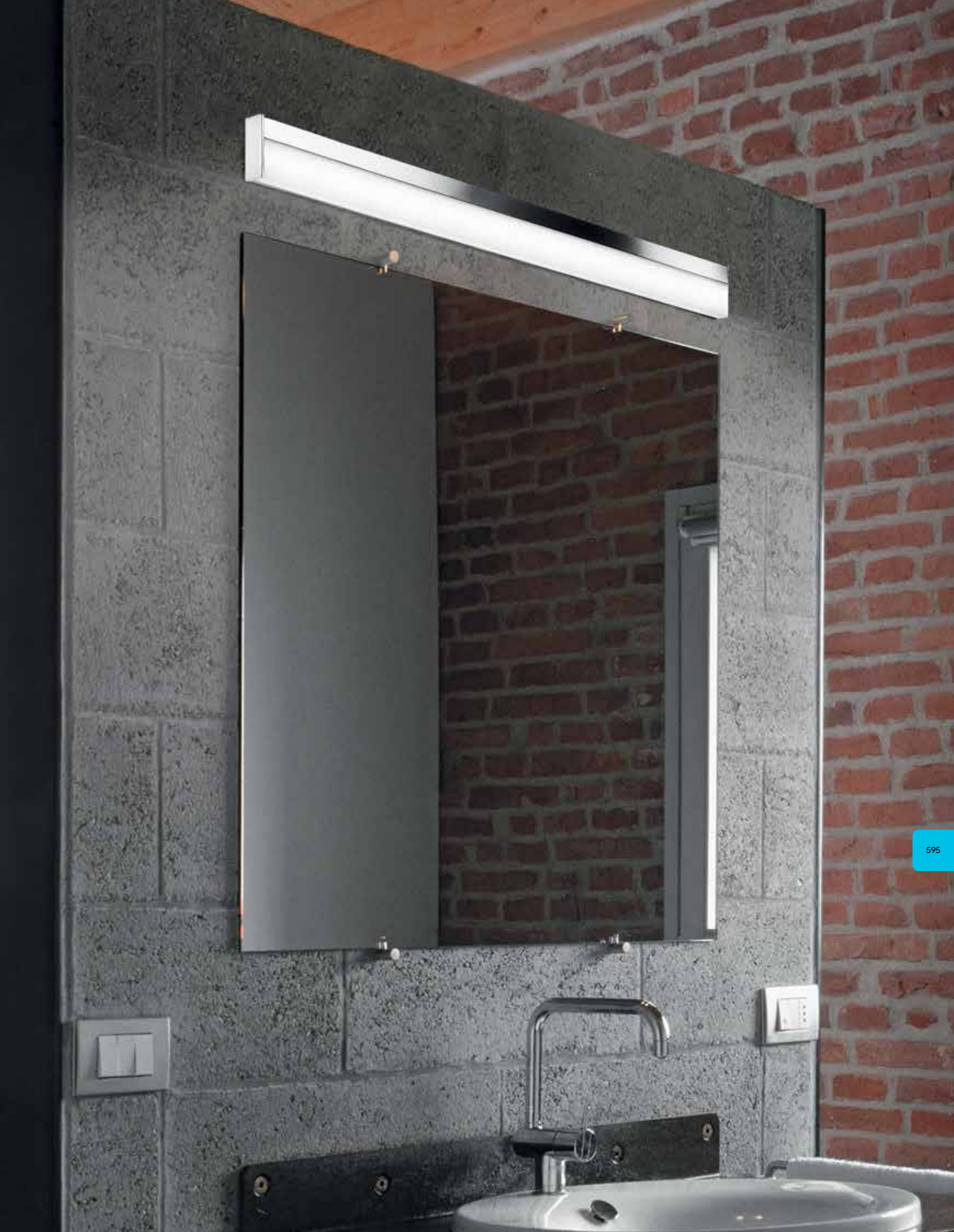



## XAVI

chrom, Glas matt · chrome, mat glass ·  
 chrome, verre mat · chrom, mat glas · cromo, vidrio mate ·  
 cromo, vetro sabbaiato · crom, sticla mata · kromi, mattalasi ·  
 chrom, szkło matowane · krom, mat cam



## HUGO

chrom, Glas matt · chrome, mat glass ·  
 chrome, verre mat · chrom, mat glas · cromo, vidrio mate ·  
 cromo, vetro sabbaiato · crom, sticla mata · kromi, mattalasi ·  
 chrom, szkło matowane · krom, mat cam



↔ 30,4 cm, ↑ 8 cm, ↗ 6 cm  
 excl. 2 x E14, max. 28 W

↔ 40,5 cm, ↑ 8 cm, ↗ 6 cm  
 excl. 3 x E14, max. 28 W

↔ 16,5 cm, ↓ 16 cm, ↗ 15 cm  
 incl. 1 x G9, 28 W  
 370 lm, 2.800 K



2803021-06



2803031-06



8801211-06



## MATTIMO

chrom, Acryl · chrome, acryl ·  
chrome, acryl · chroom, acryl · cromo, acrílico ·  
cromo, acrílico · crom, acrílic · kromi, akryyli ·  
chrom, akryl · krom, akrilik

IP44

597

↔ 40 x 5,5 cm, √ 8,5 cm  
incl. 1 x SMD-LED, 4,3 W  
450 lm, 3.000 K



283270106

↔ 60 x 5,5 cm, √ 8,5 cm  
incl. 1 x SMD-LED, 6,5 W  
680 lm, 3.000 K



283270206

↔ 80 x 5,5 cm, √ 8,5 cm  
incl. 1 x SMD-LED, 8,6 W  
880 lm, 3.000 K



283270306

## COMPO

Aluminium gebürstet oder weiß · brushed aluminium or white ·  
 aluminium balayé ou blanc · geborsteld aluminium of wit ·  
 aluminio pulido o blanco · alluminio spazzolato o bianco ·  
 aluminiiu lucios sau alb · harjattu alumiini tai valkoinen ·  
 aluminium szczotkowane lub biały · alüminyum veya beyaz

**IP65**

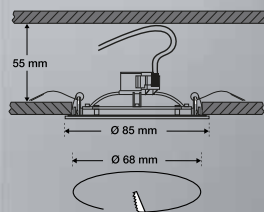

Ø 8,5 cm  
 incl. 1 x SMD-LED, 5,5 W  
 380 lm, 3.000 K

A+

IP65



629510101  
 629510105

**01** weiß · white  
**05** Aluminium gebürstet · brushed aluminium



## SAM

chrom, Glas matt · chrome, mat glass ·  
chrome, verre mat · chroom, mat glas · cromo, vidrio mate ·  
cromo, vetro sabbato · crom, sticla mata · kromi, mattalasi ·  
chrom, szkło matowane · krom, mat cam



IP44



## NANDO

chrom, Glas matt · chrome, mat glass ·  
chrome, verre mat · chroom, mat glas · cromo, vidrio mate ·  
cromo, vetro sabbato · crom, sticla mata · kromi, mattalasi ·  
chrom, szkło matowane · krom, mat cam

IP44



## CUBO

chrom, Glas klar · chrome, clear glass ·  
chrome, verre claire · chroom, helder glas · cromo, vidrio claro ·  
cromo, vetro chiaro · crom, sticlă transparentă · kromi, kirkas lasi ·  
chrom, przezroczyste szkło · krom, şeffaf

IP44



↔ 26 x 26 cm, ↑ 8,5 cm  
incl. 4 x SMD-LED, 4,5 W  
4 x 400 lm, 3.000 K



680611206



Ø 25 cm, ↑ 11 cm  
incl. 3 x SMD-LED, 4,5 W  
3 x 430 lm, 3.000 K



680711206



↔ 25 x 25 cm, ↗ 10 cm  
incl. 4 x SMD-LED, 4,5 W  
4 x 400 lm, 3.000 K



681910406



## APART

Acryl, chrom · acryl, chrome ·  
 acryl, chrome · acryl, chroom · acrílico, cromo ·  
 acrilico, cromo · acrilic, crom · akryyli, kromi ·  
 akryl, chrom · akrilik, krom

IP44



Ø 35 cm, ↑ 9,5 cm,  
 incl. SMD-LED, 18 W  
 1.600 lm, 3.000 K

A+ IP44

659411806



Ø 41 cm, ↑ 10 cm,  
 incl. SMD-LED, 24 W  
 2.100 lm, 3.000 K

A IP44

659412406



## CLARIMO

weiß / Acryl oder titanfarbig / Acryl · white / acryl or titan / acryl ·  
 blanc / acryl ou titane / acryl · wit / acryl of titaan / acryl ·  
 blanco / acrílico o titán / acrílico · bianco / acrilico o titano / acrilico ·  
 alb / acrilic sau titaniu / acrilic · valkoinen / akryyli tai titaani / akryyli ·  
 biały / akryl lub tytanowy / akryl · beyaz / akrilik veya titan / akrilik

IP44



01



07

## CONDUS

Metall, Glas matt · metal, mat glass ·  
 metale, verre mat · metaal, mat glas · metal, vidrio mate ·  
 metallo, vetro sabbiato · metal, sticla mata · metalli, mattalasi ·  
 metal, szkło matowane · metal, mat cam

IP44



Ø 33 cm, ↓ 9 cm,  
 incl. SMD-LED, 18 W  
 1.600 lm, 3.000 K



659011801  
 659011887



Ø 31,5 cm, ↓ 8 cm  
 excl. 1 x E27, max. 42 W



6801011-01  
 6801011-06  
 6801011-07



**01** weiß · white  
**06** chrom · chrome  
**07** Nickel matt · nickel mat  
**87** titanfarbig · titanium-coloured





# Leuchtmittel

Light sources  
Ampoules  
Lichtbronnen  
Fuentes de luz  
Lampadine  
Becuri  
Valonlähteet  
Źródła światła  
Işık kaynakları

# LED-Leuchtmittel

LED bulbs · Ampoules LED · LED-lampen · Bombillas a LED · Lampadine a LED ·  
Becuri cu LED-uri · LED-Valonlähtet · Żarówki LED · LED ampuller



↓ 110 mm, ↔ 60 mm  
LED E27, 10 W  
806 lm, 3.000 K  
25.000 h

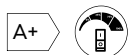

**988-10**



↓ 98 mm, ↔ 37 mm  
LED E14, 6 W  
470 lm, 3.000 K  
25.000 h



**989-66**



↓ 80 mm, ↔ 45 mm  
LED E14, 6 W  
470 lm, 3.000 K  
25.000 h



**983-66**



↓ 52 mm, ↔ 50 mm  
LED GU10, 5 W  
400 lm, 3.000 K, ⚡ 110°  
25.000 h



**956-55**



↓ 52 mm, ↔ 50 mm  
LED GU10, 5 W  
400 lm, 3.000 K, ⚡ 36°  
20.000 h



**956-5736**



↓ 55 mm, ↔ 18 mm  
LED G9, 3,5 W  
320 lm, 3.000 K  
25.000 h

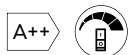

**929-230** Blister: 2 St./2 pc.

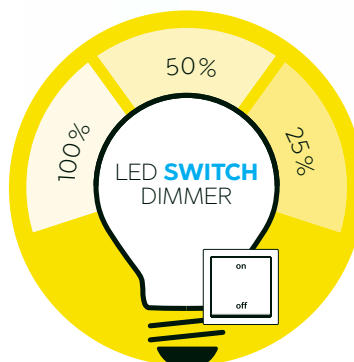

## DIMMEN OHNE DIMMER

Dimming without dimmer · Ajuster le niveau  
d'éclairage sans variateur · Dimmen zonder dimmer ·  
Regulable sin regulador · Dimmerabile senza Dimmer ·  
Ajustarea nivelului de lumina fara variator de lumina ·  
Himmentäminen ilman himmennintä · Ściemnianie bez ściemniacza



↑ 106 mm, ↔ 60 mm  
LED E27, 6 W  
470 lm, 3.000 K  
25.000 h



**987-60**



↑ 110 mm, ↔ 60 mm  
LED E27, 7 W  
560 lm, 3.000 K  
25.000 h



**dimmable**

**988-700**



↑ 110 mm, ↔ 60 mm  
LED E27, 10 W  
800 lm, 3.000 K  
25.000 h



**dimmable**

**988-110**



↑ 75 mm, ↔ 45 mm  
LED E27, 4 W  
320 lm, 3.000 K  
25.000 h



**986-40**

**986-43** Blister: 3 St./3 pc.



↑ 78 mm, ↔ 45 mm  
LED E27, 5 W  
400 lm, 3.000 K  
25.000 h



**986-60**

**986-63** Blister: 3 St./3 pc.



↑ 130 mm, ↔ 37 mm  
LED E14, 4 W  
320 lm, 3.000 K  
25.000 h



**990-40**



↑ 99 mm, ↔ 37 mm  
LED E14, 4 W  
320 lm, 3.000 K  
25.000 h



**989-40**

**989-43** Blister: 3 St./3 pc.



↑ 102 mm, ↔ 37 mm  
LED E14, 5 W  
400 lm, 3.000 K  
25.000 h



**dimmable**

**989-56**



↑ 99 mm, ↔ 37 mm  
LED E14, 6 W  
470 lm, 3.000 K  
25.000 h



**989-60**

**989-63** Blister: 3 St./3 pc.



↑ 80 mm, ↔ 45 mm  
LED E14, 4 W  
320 lm, 3.000 K  
25.000 h



**983-40**

**983-43** Blister: 3 St./3 pc.



↑ 80 mm, ↔ 45 mm  
LED E14, 5 W  
400 lm, 3.000 K  
25.000 h



**dimmable**

**983-56**



↑ 80 mm, ↔ 45 mm  
LED E14, 5 W  
400 lm, 3.000 K  
25.000 h



**983-60**

**983-63** Blister: 3 St./3 pc.



↑ 108 mm, ↔ 60 mm  
LED E27, 4 W  
450 lm, 2.800 K  
25.000 h



**987-410**



↑ 78 mm, ↔ 45 mm  
LED E14, 4 W  
450 lm, 2.800 K  
25.000 h



**983-410**

# LED-Leuchtmittel

LED bulbs · Ampoules LED · LED-lampen · Bombillas a LED · Lampadine a LED ·  
Becuri cu LED-uri · LED-Valonlähtet · Żarówki LED · LED ampuller



↑ 80 mm, ↔ 50 mm  
LED E14, 5 W  
400 lm, 3.000 K, ⚡ 120°  
25.000 h



**955-55**



↑ 57 mm, ↔ 50 mm  
LED GU10, 3 W  
250 lm, 3.000 K, ⚡ 110°  
25.000 h



**956-30**



dimmable

↑ 52 mm, ↔ 50 mm  
LED GU10, 5 W  
400 lm, 3.000 K, ⚡ 36°  
20.000 h



**956-5936**



↑ 60 mm, ↔ 50 mm  
LED GU10, 5 W  
400 lm, 3.000 K, ⚡ 120°  
25.000 h



**955-50**



↑ 50 mm, ↔ 50 mm  
LED GU5,3/MR16, 3 W  
260 lm, 3.000 K, ⚡ 110°  
25.000 h



**916-30**



dimmable

↑ 50 mm, ↔ 20 mm  
LED G9, 3 W  
300 lm, 3.000 K  
25.000 h



**929-2300** Blister: 2 St./2 pc.



dimmable

↑ 55 mm, ↔ 18 mm  
LED G9, 3 W  
250 lm, 3.000 K  
25.000 h



**929-235** Blister: 2 St./2 pc.



↑ 48 mm, ↔ 16 mm  
LED G9, 2,5 W  
210 lm, 3.000 K  
25.000 h



**929-220** Blister: 2 St./2 pc.





# LED-Filament-Leuchtmittel

LED-filament bulbs · Lampes LED-filament · LED-gloeilampen · Lámparas de filamento de LED ·  
Lampade a filamento LED · Lámpi cu LED-filament · LED-hehkulamput · Lampy LED-żarowe ·  
LED-filamanlı lambalar



↓ 106 mm, ↔ 60 mm  
Filament LED E27, 8 W  
806 lm, 2.700 K  
10.000 h

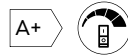

**987-6810**



↓ 110 mm, ↔ 60 mm  
Filament LED E27, 8 W  
700 lm, 2.700 K  
10.000 h

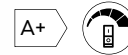

**987-6700**



↓ 143 mm, ↔ 95 mm  
Filament LED E27, 6 W  
810 lm, 2.700 K  
10.000 h

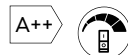

**985-6810**



↓ 173 mm, ↔ 125 mm  
Filament LED E27, 6 W  
810 lm, 2.700 K  
10.000 h

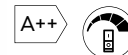

**986-6810**



↓ 80 mm, ↔ 45 mm  
Filament LED E14, 4 W  
470 lm, 2.700 K  
10.000 h

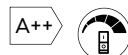

**983-4470**



↓ 99 mm, ↔ 35 mm  
Filament LED E14, 4 W  
470 lm, 2.700 K  
10.000 h

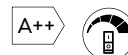

**989-4470**

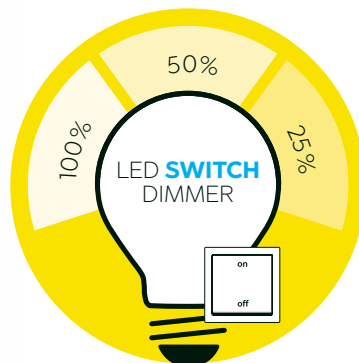

## DIMMEN OHNE DIMMER

Dimming without dimmer · Ajuster le niveau  
d'éclairage sans variateur · Dimmen zonder dimmer ·  
Regulable sin regulador · Dimmerabile senza Dimmer ·  
Ajustarea nivelului de lumina fara variator de lumina ·  
Himmentäminen ilman himmennintä · Ściemnianie bez ściemniacza

# LED-Filament-Leuchtmittel

LED-filament bulbs · Lampes LED-filament · LED-gloeilampen · Lámparas de filamento de LED · Lampade a filamento LED · Lămpi cu LED-filament · LED-hehkulamput · Lampy LED-żarowe · LED-filamanlı lambalar



↑ 115 mm, ↔ 60 mm  
Filament LED E27, 4 W  
400 lm, 3.000 K  
10.000 h

A++

**987-400**

**987-2400** Blister: 2 St./2 pc.



↑ 105 mm, ↔ 60 mm  
Filament LED E27, 6 W  
600 lm, 3.000 K  
10.000 h

A+



**dimmable**

**987-660**



↑ 99 mm, ↔ 35 mm  
Filament LED E14, 4 W  
400 lm, 3.000 K  
10.000 h

A++

**989-400**



↑ 99 mm, ↔ 35 mm  
Filament LED E14, 4 W  
280 lm, 2.700 K  
10.000 h

A+

**989-479**



↑ 120 mm, ↔ 35 mm  
Filament LED E14, 4 W  
400 lm, 3.000 K  
10.000 h

A++

**990-400**



↑ 78 mm, ↔ 45 mm  
Filament LED E14, 4 W  
470 lm, 3.000 K  
10.000 h

A++

**983-400**



↑ 140 mm, ↔ 64 mm  
Filament LED E27, 6 W  
600 lm, 3.000 K  
10.000 h

A+

**987-600**



↑ 140 mm, ↔ 64 mm  
Filament LED E27, 6 W  
420 lm, 2.700 K  
10.000 h

A+

**987-679**



↑ 300 mm, ↔ 30 mm  
Filament LED E27, 4 W  
320 lm, 2.700 K  
25.000 h

A+

**905-479**



↑ 135 mm, ↔ 95 mm  
Filament LED E27, 6 W  
600 lm, 3.000 K  
10.000 h

A+

**988-600**



↑ 136 mm, ↔ 95 mm  
Filament LED E27, 6 W  
600 lm, 3.000 K  
10.000 h

A+



**dimmable**

**988-660**



↑ 135 mm, ↔ 95 mm  
Filament LED E27, 6 W  
420 lm, 2.700 K  
10.000 h

A+

**988-679**



↑ 168 mm, ↔ 115 mm  
 Filament LED E27, 4 W  
 320 lm, 2.700 K  
 25.000 h



**901-479**



↑ 138 mm, ↔ 115 mm  
 Filament LED E27, 4 W  
 320 lm, 2.700 K  
 25.000 h



**902-479**



↑ 138 mm, ↔ 80 mm  
 Filament LED E27, 4 W  
 320 lm, 2.700 K  
 25.000 h



**903-479**



↑ 135 mm, ↔ 95 mm  
 Filament LED E27, 4 W  
 320 lm, 2.700 K  
 25.000 h



**904-479**



↑ 330 mm, ↔ 180 mm  
 Filament LED E27, 8 W  
 560 lm, 2.700 K  
 25.000 h



**908-879**



↑ 320 mm, ↔ 180 mm  
 Filament LED E27, 8 W  
 560 lm, 2.700 K  
 25.000 h



**906-879**



↑ 265 mm, ↔ 200 mm  
 Filament LED E27, 8 W  
 560 lm, 2.700 K  
 25.000 h



**907-879**

# Displays

Présentoirs · Espositores · Espositori ·  
Display-uri · Telineet · Wyświetla · Teşhir



# Displays

Présentoirs · Espositores · Espositori · Display-uri · Telineet · Wyświetla · Teşhir



Topper PT 0011 DE



Topper PT 0012 DE



Topper PT 0013 DE



611

↔ 80 x 40 cm, ↑ 165 cm

**RK51**

# Displays

Présentoirs · Espositores · Espositori ·  
Display-uri · Telineet · Wyświetla · Teşhir



612

↔ 240 x 140 cm, ↑ 241 cm

**RK65**

# Displays

Présentoirs · Espositores · Espositori ·  
Display-uri · Telineet · Wyświetla · Teşhir



613

↔ 80 x 63 cm, ↓ 184 cm

**RK58**

# Displays

Présentoirs · Espositores · Espositori ·  
Display-uri · Telineet · Wyświetla · Teşhir



614

↔ 120 x 80 cm, ↓ 235 cm

**RK10**



# Displays

Présentoirs · Espositores · Espositori ·  
Display-uri · Telineet · Wyświetla · Teşhir



↔ 118 x 78 cm, ↓ 160 cm

**RK43**



↔ 118 x 78 cm, ↓ 170 cm

**RK45**

# Displays

Présentoirs · Espositores · Espositori ·  
Display-uri · Telineet · Wyświetla · Teşhir



# Displays

Présentoirs · Espositores · Espositori ·  
Display-uri · Telineet · Wyświetla · Teşhir



617

↔ 120 x 80 cm, ↓ 210 cm

**RK63**

# Displays

Présentoirs · Espositores · Espositori ·  
Display-uri · Telineet · Wyświetla · Teşhir

H<sub>2</sub>O



618

↔ 120 x 80 cm, ↓ 225 cm

**RK13**

# Displays

Présentoirs · Espositores · Espositori ·  
Display-uri · Telineet · Wyświetla · Teşhir

VINTAGE



619

↔ 120 x 80 cm, ↑ 235 cm

**RK39**



# Spezifikationen

Specifications  
Spécifications  
Specificaties  
Especificaciones  
Specifiche  
Specificații  
Tekniset tiedot  
Specyfikacje  
Özellikler

# Produkteigenschaften

Features · Caractéristiques · Kenmerken · Acabados ·  
Caratteristiche · Caracteristici · Ominaisuudet · Cechy · Özellikleri



## Schalter · Switch

Interrupteur · Schakelaar · Interruptor ·  
Interruttore · Intrerupator · Kytkin ·  
Przełącznik · Anahtar



## Fußschalter · Footswitch

interrupteur à pédale · Voetschakelaar ·  
Interruptor de pie · interruttore a pedale ·  
comutator picior · Päälle / pois jalkakytin ·  
wyłącznik nożny · Ayak anahtarı



## Schnurschalter · Cable switch

Interrupteur de cordon · Snoerschakelaar ·  
Cable de interruptor · Interruttore su cavo ·  
Intrerupator cu cablu · katkaisin ja johto ·  
Przełącznik na kablu · Kablo anahtar



## On/Off Touch Funktion · On/Off Touch function

Interrupteur tactile On/Off · Touch schakelaar On/Off ·  
Función táctil On/Off · Interruttore touch On/Off ·  
Intrerupator tactil On/Off · Kosketuskäyttöinen On/Off ·  
Funkcja dotykowa On/Off · Temas kontrolü On/Off



## Getrennt schaltbar · Separately switchable

Interrupteurs séparés · Gescheiden schakelbaar ·  
Interruptores separados · Interruttori separati ·  
Intrerupatoare separate · Erikseen kytkettävissä ·  
Oddzileny przełącznik · Dışarıdan anahtarlı



## Fernbedienung · Remote control

Commande à distance · Afstandsbediening ·  
Mando a distancia · Comando a distanza ·  
Telecomanda · Kauko-ohjain · Pilot · Uzaktan kumanda



## Integrierter Dimmer · Integrated dimmer

Variateur intégré · Geïntegreerde dimmer ·  
Regulador integrado · Dimmer integrato ·  
Variator de lumina integrat · Integroitu himmennin ·  
Wbudowany ściemniacz · Entegre kısma/açma düğmesi



## Zugschalter · Pull switch

Interrupteur de trait · Trekschakelaar ·  
Interruptor de tiro · Interruttore con tirata ·  
Interupator de tragere · Vetokytin ·  
Przełącznik pociągany · Çekemli anahtar



## Sensordimmer · Sensor dimmer

Variateur tactile · Touchdimmer ·  
Regulador con sensor · Touchdimmer ·  
Variator cu senzor · Kosketushimmennin ·  
Czujnik ściemniania · El dimeri



## Extern dimmbar · Externally dimmable

Dimmable avec variateur externe · Extern dimbaar ·  
Dimmable por regulador externo · Dimmerabile con dimmer  
esterno · variator extern de lumina · himmennettävissä ·  
Zewnętrznie ściemniana · Harici Dim Ayarı



## RGB Farbwechsler · RGB Colorchanging

Changement de couleur RGB · RGB Kleurverandering ·  
Cambio de color RGB · Cambia colore RGB ·  
Schimbator de culoare RGB · Värinvaihto RGB ·  
Zmieniający kolor RGB · Renk değiştirilen RGB



## Lichtfarbe einstellbar · Adjustable light color

Couleur de lumière réglable · Lichtkleur instelbaar ·  
Color de luz regulable · Colore della luce regolabile ·  
Lumina colorata reglabila · Värilämpötila säädettävissä ·  
Regulowana barwa światła · Ayarlanabilir ışık rengi



## Made in Europe · Made in Europe

Made in Europe · Made in Europe · Made in Europe ·  
Made in Europe · Made in Europe · Made in Europe ·  
Made in Europe · Made in Europe



## Höhenverstellbar · Adjustable height

Hauteur réglable · In hoogte verstelbaar ·  
Altura regulable · Altezza regolabile ·  
Inaltime reglabila · Säädettävä korkeus ·  
Regulowana wysokość · Ayarlanabilir yükseklik



## Schwenkbar · Tilttable

Pivotant · Draaibaar · Pivotante ·  
Girevole · Pivotant · Suunnattava ·  
Skrętny · Eğilebilir



## Steckdose · Plug

Prise · Stekker · Enchufe · Spina ·  
Priza · Katkaisin · Gniazdko · Priz



## Vergrößerung 3x · Magnification 3x

Magnification 3x · Vergroting 3x · Aumentos 3x ·  
Ingrandimento 3x · Suplimentare 3x · Suurentava 3x ·  
Powiększenie 3x · Büyütme 3x



## 4 fach TOUCH · 4 level Touch function

Interrupteur tactile 4 niveaux · Touch schakelaar 4 niveaus ·  
Función Táctil 4 nivel · Interruttore touch 4 livelli ·  
Intrerupator tactil 4 nivele · Kosketuskäyttöinen 4 taso ·  
Funkcja dotykowa 4 poziomy · Temas kontrolü 4 düzeyleri





Flexibel · Flexible  
Flexible · Flexibel · Flexible · Flessibile ·  
Flexibil · Joustava · Elastyczne · Esnek



Lichtfarbe stufenlos einstellbar · Light color infinitely  
variable  
Couleur de lumière infiniment variable · Lichtkleur tra-  
ploos instelbaar · Color de luz infinitamente variable ·  
Colore della luce infinitamente variabile · Culoare lumina  
infiniit variabilă · Valon väri portaattomasti · Jasny kolor  
bezstopniowo · Açık renk sonsuz deęişken



USB Anschluss · USB connection  
Entrée USB · USB aansluiting · Conexión USB ·  
Connessione USB · Conexiune USB · USB-liitäntä ·  
Połączenie USB · USB baęlantısı



USB Anschluss mit Ladefunktion · Recharging USB  
connection  
Entrée USB de rechargement · Opladende USB  
aansluiting · Conexión USB de recarga · Connessione  
USB di ricarica · Conexiune USB reîncărcare ·  
Lataaminen USB-liitäntä · ładowania USB połączenie ·  
şarj USB baęlantısı



Nachtlicht · Night light  
Veilleuse de nuit · Nachtlicht · Luz de la noche ·  
Luce notturna · Lampă de noapte · Yövalo ·  
Lampka nocna · Gece lambası



Gestensteuerung · Gesture control  
Contrôle gestuel · Gebaarbediening · Control gestual ·  
Controllo gestuale · Control prin gesturi/miscarea mainii ·  
Kädellä ohjattava liiketunnistin · Sterowana gestami ·  
Jest Kontrol



Up and down Beleuchtung · Up and Down lighting  
Point lumineux en haut et en bas · Lichtpunt boven en  
onder · Luz de arriba y abajo · Luce su e giù · Sus şi în  
jos lumina · Ylös ja alas valoa · W górę iw dół światło ·  
Yukarı ve aşağı ışık



Dimmbar mit Schalter · Dimmable via switch  
Réglable avec interrupteur · Dimbaar via schakelaar ·  
Regulable mediante interruptor · Dimmerabile tramite  
interruttore · Estompat prin comutator · Himmennettävä  
kytkimen · Ściemnialne za pośrednictwem przełącznika ·  
Anahtarı üzerinden kısılabilir



Stufenlos dimmbar mit Schalter · Infinitely dimmable  
with switch  
Infiniment réglable avec interrupteur · Traploos dimbaar met  
schakelaar · Infinitamente regulable con interruptor ·  
Infinitamente dimmerabile con interruttore · Reglabil infinit  
cu un intrerupator · Portaattomasti himmennettävä kytki-  
mellä · Bezstopniowo ściemnialna z przełącznikiem ·  
Duraksız anahtar ile ayarlanabilir ışık şiddeti



Sleep-Timer · Sleep timer  
Compte-minutes de sommeil · Sleptimer ·  
Temporizador de sueño · Timer di spegnimento ·  
Sleep timer · Uniajastin · Wyłącznik czasowy ·  
Uyku Zamanlayıcısı



Weckfunktion · Wake up function  
Fonction réveil · Wekfunctie · Despierte ·  
Sveglia · Trezeste-te funcția · Herätys toiminto ·  
Obudź się funkcji · İşlevini uyan



Induktive Ladestation · Inductive loading station  
Station de chargement inductif · Inductief laadstation ·  
Estación de carga inductiva · Stazione di carico  
induttivo · Stație de încărcare inductivă · Induktiivinen  
latausasema · Stacja ładowania indukcyjnego · Endüktif  
yükleme istasyonu



Musterschutz · Registered model  
Modèle déposé · Beschermd model ·  
Modelo certificado · Modello depositato ·  
Înregistrați model · Rekisteröity malli ·  
Zarejestrowany wzór · Kayıtlı modeli



Starlight Effekt · Starlight effect  
Effet étoiles · Starlight effekt · Efecto estrella ·  
Effetto stelle · Efect de "stele" · Tähti efekti ·  
Efekt starlight · Yıldız Etkisi



RGBW Farbwechsler · RGBW Colorchanging  
Changement de couleur RGBW · RGBW Kleurverandering ·  
Cambio de color RGBW · Cambia colore RGBW ·  
Schimbator de culoare RGBW · Värvvaihto RGB ·  
Zmieniający kolor RGBW · Renk deęiştiren RGBW



Ohne Leuchtmittel · Lamp(s) excluded  
Sans ampoule(s) · Zonder lichtbron(nen) ·  
Sin bombilla(s) · Lampadina Esclusa · Fara bec (s) ·  
Ilman polttimo (s) · Bez żarówki (s) · Ampul olmadan (lar)



Lichtfarbe mit Schalter einstellbar · Light color  
adjustable with switch  
Couleur de lumière réglable avec interrupteur · Lichtkleur  
instelbaar met schakelaar · Color de la luz ajustable con  
interruptor · Colore della luce regolabile con interruttore ·  
Culoarea luminii reglabila cu un comutator · Valon väri  
säädettävällä kytkimellä · Kolor światła regulowane z  
przełącznikiem · Anahtar ile ayarlanabilir ışık rengi.



Bewegungssensor · Motion sensor  
Détecteur de mouvement · Bewegungssensor ·  
Sensor de movimiento · Sensore di movimento ·  
Sensor de mişcare · Liiketunnistin · Czujnik ruchu ·  
Hareket sensörü

# Farben & Materialien

Colours and materials · Couleurs et matériaux · Kleuren en materialen · Colores y materiales ·  
Colori e materiali · Culori si materiale · Värit ja materiaalit · Kolory i materiały · Renkler ve malzemeler

## 00 transparent · transparent

transparent · transparant · transparente · transparente ·  
transparent · kirkas · przezroczysty · şeffaf

## 01 weiß · white

blanc · wit · blanco · bianco · alb · valkoinen · biały · beyaz

## 02 schwarz · black

noir · zwart · negro · nero · negru · musta · czarny · siyah

## 03 Messing poliert · polished brass

laiton polis · gepolijst messing · bronze · ottone lucido ·  
bronz · messinki · mosiądz polerowany · piringç

## 04 altmessing · old brass

laiton fumé · oud brons · bronze viejo · ottone invecchiato ·  
bronz antic · antiikkimessinki · patyna · antik piringç

## 05 Aluminium gebürstet · brushed aluminium

aluminium balayé · geborsteld aluminium · aluminio pulido ·  
alluminio spazzolato · aluminiu lucios · harjattu alumiini ·  
aluminium szczotkowane · alüminyum

## 06 chrom · chrome

chrome · chroom · cromo · cromo · crom ·  
kromi · chrom · krom

## 07 Nickel matt · nickel mat

nickel mat · nikkellat · níquel mate · nichel opaco ·  
nichel mat · harjattu teräs · nikiel mat · mat nikel

## 08 Messing matt · brass mat

laiton mat · messing mat · bronze mate · ottone satinato ·  
bronz mat · mattamessinki · mosiądz mat · mat piringç

## 09 kupferfarbig · copper

cuivré · koperkleurig · color cobre · colore rame · cupru ·  
kuperinvärinen · kolorze miedzi · bakir renkli

## 10 rot · red

rouge · rood · rojo · rosso · rosu ·  
punainen · czerwony · kırmızı

## 11 grau · grey

gris · grijs · gris · grigio · gri · harmaa · popielaty · gri

## 12 blau · blue

bleu · blauw · azul · azzurro · gri · sininen · niebieski · mavi

## 13 amber · amber

ambre · amber · ámbar · ambra · amber · meripihka ·  
bursztynowy · amber

## 14 braun · brown

brun · bruin · marron · marrone · maro · ruskea ·  
brązowy · kahverengi

## 15 grün · green

vert · groen · verde · verde · verde · vihreä · zielony · yeşil

## 16 gelb · yellow

jaune · geel · amarillo · giallo · galben ·  
keltainen · żółty · sarı

## 17 mehrfarbig · multicolor

multicolore · multicolor · multicolor · multicolore ·  
multicolor · monivärinen · multi-kolor · çok renkli

## 18 orange · orange

orange · oranje · naranja · arancione · portocaliu ·  
oranssi · pomarańczowy · turuncu

## 19 türkis · turquoise

turquoise · turquoise · turquesa · turchese · turcoaz ·  
turkoosi · turkusowy · turkuvaz

## 20 schwarz-chrom · black-chrome

noir-chrome · zwart-chroom · cromo-negro · nero-cromo ·  
negru-crom · mustakromi · czarny-chrom · siyah-krom

## 24 rostfarbig · rusty

rouille · roestkleur · óxido · ruggine · ruginiu · rustiikki ·  
miedź · pas

## 26 braun · brown

brun · bruin · marron · marrone · maro · ruskea ·  
brązowy · kahverengi

## 27 weiß antik · antique white

blanc antique · antiek wit · blanco decapé · bianco anticato ·  
alb antic · antiikkivalkoinen · antyczny biały · antik beyaz

## 28 rostfarbig antik · antique rust

rouille antique · roestkleur antiek · oxido · ruggine anticato ·  
ruginiu antic · rustiikki · antyczny rdzawy · antik pas rengi

## 29 kupfer matt · copper mat

cuivre mat · koper mat · estera de cobre · rame opaco ·  
cupru mat · kupari mat · miedź mat · bakır mat

## 30 holzfarbig · wood coloured

couleur bois · houtkleur · color madera · colore di legno ·  
culoare lemn · puunvärinen · kolor drewna · ahşap renk

## 31 weiß matt · white mat

blanc mat · wit mat · estera blanca · bianco opaco · alb mat ·  
valkoinen matto · biały mat · beyaz mat

## 32 schwarz matt · black mat

noir mat · mat zwart · estera negra · nero opaco ·  
negru mat · musta matto · czarny mat · siyah mat

## 41 taupe · taupe

taupe · taupe · gris pardo · taupe · taupe ·  
ruskeanharmaa · ciemnoszary · taupe

## 42 anthrazit · anthracite

antracite · antraciet · antracita · anthracite · antracit ·  
antrasiitti · antracyt · antrasit

## 51 apfelgrün · applegreen

vert pomme · appelgroen · verde manzana · verde mela ·  
verde mar · omenanvihreä · zielone jabłko · elma yeşili

## 52 transparent klar · transparent clear

transparent claire · transparant helder · transparente claro ·  
transparente chiaro · transparent clar · kirkas ·  
przezroczysty · şeffaf

- 61** grau antik · antique grey  
gris ancien · antiek grijs · gris antiguo · grigio antico ·  
antic gri · antiikki harmaa · starodawny szary · antika gri
- 62** kupfer antik · antique copper  
cuivre ancien · antiek koper · cobre antiguo · rame antico ·  
cupru antic · antiikki kupari · antyczne miedzi · antik bakır
- 64** bronze · bronze  
bronze · bronze · bronce · bronzo · bronz ·  
pronssi · brąz · tunç
- 78** betonfarbig · concrete look  
couleur beton · beton kleur · color concreto ·  
calcestruzzo · culoare beton · konkreettisia väri ·  
konkretny kolor · beton rengi
- 79** goldfarbig · gold  
or · goud · oro · oro · aur · kultaa · złota · altın
- 87** titanfarbig · titan  
titane · titaan · titán · titano · titaniu ·  
titaani · tytanowy · titan
- 88** silber antik · antique silver  
argent antique · antiek zilver · plateado antiquo ·  
argento anticato · argint antic · antiikkihopea ·  
antyczne srebro · gümüş antika
- 89** silberfarbig · silver  
argent · zilver · plata · argento · argint ·  
hopea · srebrny · gümüş
- 91** lila · lilac  
lilla · lilla · lila · lilla · lila · lila · liliowy · leylak
- 92** purpurrot · purple  
pourpre · paars · púrpura · porpora · purpuriu ·  
purppura · purpurowy · mor
- 93** pink · pink  
rose · pink · rosa · rosa · roz · pinkki · różowy · pembe

# Get your light connected.

FR NL ES IT RO FI PL

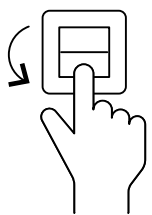

## WiZ CLICK

Simple et efficace. Deux modes d'éclairage préférés peuvent être commandés via l'interrupteur d'éclairage existant.

Eenvoudig en effectief. Twee voorkeurstellingen kunnen worden bediend via de bestaande lichtsckakelaar.

Helppoa ja tehokasta. Kaksi toivottua valo asetusta jota voidaan käyttää seinäkytkimellä.

Simplu si efectiv. Pot fi operate 2 moduri de iluminat preferate prin comutatorul de lumina existent.

Semplice ed efficace. È possibile utilizzare due modalità di illuminazione preferite tramite l'interruttore della luce esistente.

Simple y efectivo. Dos ambientes de luz preferidos pueden operar a través del interruptor convencional.

Proste i efektywne. Dwa preferowane tryby oświetlenia można obsługiwać za pomocą dostępnego przełącznika oświetlenia.

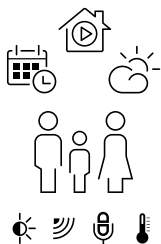

## WiZ MAGIC

Contrôle des lumières par programme horraire, par capteurs ou par simples commandes vocales. Compatible avec Amazon Alexa et Google Home.

Aansturing van de lampen met tijdschema's, door sensoren of via eenvoudige spraakopdrachten. Compatibel met Amazon Alexa en Google Home.

Valoja voi säätää aikataulutetusti, sensoreilla tai yksinkertaisilla ääni komennoilla. Yhteensopiva Amazon Alexan ja Google Homen kanssa.

Controlul luminilor prin programarea orei/timpului ,cu senzori sau printr-o simpla comanda verbala.Compatibil cu Amazon Alexa si Google Home.

Controllo delle luci secondo gli orari, con sensori o semplici comandi verbali. Compatibile con Amazon Alexa e Google Home.

Control de las luces con horarios, con sensores o por simples comandos de voz. Compatible con Alexa de Amazon y Google Home.

Ustawianie i sterowanie lampami za pomocą harmonogramów.



## WiZ APP

Installation facile et rapide. Toutes les fonctionnalités et flexibilité disponible avec l'application WiZ, téléchargeable sur App Store ou Google Play.

Eenvoudig en snel te installeren. Volledige functionaliteit en flexibilititeit met de WiZ-app - beschikbaar in de App Store of op Google Play.

Helppo ja nopea asentaa. Käyttö WiZ-aplikaatiolla - saatavissa App Storesta tai Google Play kaupasta.

Instalare usoara si rapida.Functionalitate completa si flexibilitate cu WIZ App -disponibil pe App store sau pe Google Play.

Facile e veloce da installare.Piena funzionalità e flessibilità con l'App Wiz disponibile su App Store e su Google Play.

Fácil y rápido de instalar. Amplia funcionalidad y flexibilidad con la aplicación WiZ, disponible en la App Store o en Google Play.

Prosta i szybka instalacja. Pełna funkcjonalność i elastyczność dzięki aplikacji WiZ – dostępnej w App Store lub Google Play.



## WiZ MOTE

Contrôle via la télécommande et possibilité de sauvegarder quatre modes d'éclairage favoris.

Aansturen via de afstandsbediening en mogelijkheid om vier favoriete licht instellingen te bewaren.

Toimintojen säätö kaukosäätimellä ja mahdollisuus tallentaa neljä valo asetusta.

Controlul prin telecomanda si posibilitatea de a memora/salva 4 moduri favorite.

Controllo tramite telecomando e possibilità di salvare quattro modalità luce preferite.

Control vía mando a distancia y con posibilidad de guardar 4 ambientes favoritos.

Możliwość sterowania za pomocą pilota i zapisywania czterech preferowanych trybów oświetlenia.

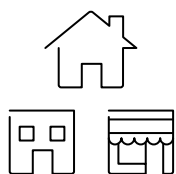

### Résidences multiples

Contrôlez et commandez plusieurs résidences simultanément et de n'importe où. Que ce soit votre propre maison ou votre deuxième résidence.

### Meerdere locaties

Controleren en aansturen van meerdere locaties tegelijkertijd en van overal. Uw thuis of uw vakantiehuis.

### Useita sijainteja

Voit hallita useita sijainteja, kotiasi tai kesäasuntoasi samanaikaisesti.

### Locatii Multiple

Control si comanda a locatiilor multiple simultan si de oriunde .Fie ca te afli acasa sau in casa de vacanta

### Molteplici Location

Controlla e comanda più sedi contemporaneamente e da qualsiasi luogo. Che tu sia casa tua o la tua casa vacanza.

### Múltiples localizaciones

Control y cambio en múltiples localizaciones simultáneamente, tanto tu casa como en tu segunda residencia.

### Kilka lokalizacji

Kontrola i sterowanie z kilku lokalizacji jednocześnie i zewsząd. Czy to z własnego domu, czy też z wakacyjnego mieszkania.

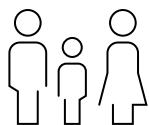

### Multiplés utilisateurs

Le nombre de personnes pour contrôler les lumières peut être déterminé individuellement.

### Meerdere gebruikers

Het aantal personen dat de lampen aanstuurt, kan individueel worden ingesteld.

### Monta eri käyttäjä

WiZ käyttäjien määrä voidaan yksilöllisesti määrittää.

### Utilizatori multipli

Numarul de persoane care sa controleze luminile poate fi setat individual.

### Molteplici Utenti

Il numero di persone per controllare le luci può essere impostato individualmente.

### Múltiples usuarios

El número de personas que controlan las luces se puede configurar individualmente.

### Kilku użytkowników

Liczba użytkowników mogących sterować lampami może być określana indywidualnie.



### Basé sur le cloud

WiZ se connecte au cloud pour stocker les préférences, partager les désirs et générer automatiquement des mises à jour.

### Cloud gebaseerd

WiZ maakt verbinding met de cloud om voorkeuren op te slaan, wensen te delen en automatische updates te genereren.

### Pilvipalveluun perustuva

WiZ ottaa yhteyden pilvipalveluun, tallentaa asetukset ja luo päivitykset automaattisesti.

### Pe baza de Cloud

WiZ te conectează la Cloud la magazinul preferat, transmite dorințele și generează update-uri în mod automat.

### Basato sul Cloud

WiZ si connette al cloud per memorizzare le preferenze, condividere desideri e generare automaticamente gli aggiornamenti.

### Basado en la nube

WiZ conecta con la nube para guardar tus preferencias, comparte y genera actualizaciones automáticamente.

### Oparte na chmurze

WiZ łączy się z chmurą, aby zapisywać preferencje, rozdzielać życzenia i automatycznie generować aktualizacje.



### Lieux multiples

Toutes les lumières peuvent être assignées à différentes pièces et contrôlées avec précision - individuellement ou en groupe.

### Meerder woonruimtes

Alle lampen kunnen worden toegewezen aan verschillende woonruimtes en nauwkeurig worden aangestuurd - individueel of in groepen.

### Useita huoneita

Jokainen valo voidaan määrittää eri huoneelle. Hallittavissa ryhmissä tai yksittäin.

### Câteva camere

Toate luminile pot fi atribuite mai multor camere diferite si pot fi controlate cu precizie -individual sau in grupuri

### Numerose stanze

Tutte le luci possono essere assegnate a stanze diverse e controllate con precisione - individualmente o in gruppi.

### Varias habitaciones

Todas las luces pueden ser asignadas a diferentes habitaciones y controladas con precisión - individualmente o en grupo

### Kilka pomieszczeń

Wszystkie lampy mogą być przyporządkowywane do różnych pomieszczeń i precyzyjnie sterowane – pojedynczo lub w grupach.

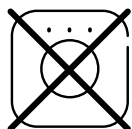

### Pas besoin de pont

Il n'y a pas besoin d'un dispositif supplémentaire pour contrôler les lumières.

### Geen hub nodig

Er is geen extra apparaat nodig om de lampen aan te sturen.

### Ei tarvetta erilliselle keskukselle

Ei tarvetta erilliselle keskukselle valojen säätämiseen.

### Nu e nevoie de nici un punct central

Nu e nevoie de o punte sau hub pentru a controla luminile

### Non sono necessari altri hub

Non è necessario un ponte o un hub aggiuntivo per controllare le luci

### No necesaria una unidad central

No es necesario una conexión adicional o unidad central para controlar las luces

### Bez konieczności stosowania dodatkowych mostków

Do sterowania lampami nie jest potrzebny żaden dodatkowy mostek.



### Technologie WiFi

WiZ utilise la technologie WiFi comme une solution sans fil sécurisée, indépendante, abordable et facile à installer.

### WiFi-technologie

WiZ gebruikt Wi-Fi-technologie als een veilige, onafhankelijke, betaalbare en eenvoudig te installeren draadloze oplossing.

### WiFi teknologia

WiZ käyttää Wi-Fi teknologiaa turvallisena, itsenäisenä, edullisena ja helppo käyttöisenä langattomana ratkaisuna.

### Technologie Wi-Fi

WiZ folosește tehnologia Wi-Fi ca o soluție de internet sigură, independentă, permisivă și ușor de instalat.

### Tecnologia Wi-Fi

WiZ utilizza la tecnologia Wi-Fi come soluzione wireless sicura, indipendente, economica e facile da installare.

### Tecnología WiFi

WiZ utiliza la tecnología Wi-Fi como una solución inalámbrica segura, independiente, asequible y fácil de instalar.

### Tecnologia WLAN

WiZ używa technologii „WLAN” jako bezpiecznego, niezależnego, niskonakładowego i łatwego w instalacji rozwiązania radiowego.



# EASYTOFIX

Einfache und sichere Montage · Easy and safe to install · Facile et sûr à installer ·  
 Eenvoudig en veilig te installeren · Seguro y fácil de instalar · Facile e sicura da installare ·  
 Instalare usoara si in siguranta · Helppo ja turvallinen asentaa · Łatwy i bezpieczny montaż



1  
 Befestigung an die Decke schrauben · Screw the basis to the ceiling · Visser la base au plafond · Schroef de bevestiging aan het plafond · Atornilla la base al techo · Avvitare la base al soffitto · Fixati baza plafonierei cu suruburi in tavan · Ruuvaa asennusosa kattoon · Przykręcić mocowanie do sufitu.



2  
 Leuchte anbringen · Place the luminaire · Placez le luminaire · Plaats het armatuur · Coloca la lámpara · Posiziona l'apparecchio · Asezati plafoniera · Kiinnitä valaisin · Umieścić lampę

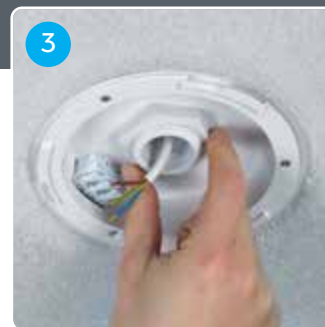

3  
 Festschrauben und problemlos anschließen · Tighten the nut and connect easily · Serrez l'écrou et connectez facilement · Draai de moer aan en sluit makkelijk aan · Aprieta la tuerca y conéctala fácilmente · Stringere il dado e collegarlo facilmente · Strangeti piulita si conectati usor · Kiristä mutteri ja asenna johdot · Przykręcić i bez problemu podłączyć



4  
 Abdeckkappe anbringen. Fertig! · Mount the cover. Finished! · Montez le couvercle. Fini! · Monteer de afdekkap. Klaar! · Monta la tapa. Listo! · Montare il coperchio. Finito! · Montati partea exterioara a plafonierei. Ati terminat! · Kiinnitä suojus. Valmis! · Założyć osłonę. Gotowe!



Diese Wandleuchte ist sowohl für den Festanschluss, als auch für den Betrieb mit Steckerzuleitung geeignet.

This wall light is suitable both for a fixed power connection, as well as for the connection of a plug-in power cable.

Cette applique convient à la fois pour une connexion d'alimentation fixe, ainsi que pour la connexion d'un câble d'alimentation enfichable.

Deze wandlamp is zowel geschikt voor een vaste stroomaansluiting als voor het aansluiten van een plug-in voedingskabel.

Esta luz de pared es adecuada tanto para una conexión de alimentación fija como para la conexión por cable de alimentación

Questa lampada da parete è adatta sia per una connessione di alimentazione fissa, sia per la connessione di un cavo di alimentazione plug-in.

Aceasta aplica este potrivita atat pentru a fi montata direct la sursa de curent, dar si pentru a fi conectata printr-un cablu de curent la priza.

Tämä seinävalaisin voidaan asentaa kiinteästi kytkentäriman avulla tai käyttämällä mukana tulevaa liitosjohtoa.

Ta lampa ścienna jest odpowiednia zarówno do podłączenia na stałe, jak również do eksploatacji przy użyciu przewodu z wtyczką.

# LED SWITCH DIMMER

Dimmen ohne Dimmer · Dimming without dimmer · Ajuster le niveau d'éclairage sans variateur · Dimmen zonder dimmer · Regulable sin regulador · Dimmerabile senza Dimmer · Ajustarea nivelului de lumina fara variator de lumina · Himmentäminen ilman himmennintä · Ściemnianie bez ściemniacza · Anahtarsız kısma/açma



100%

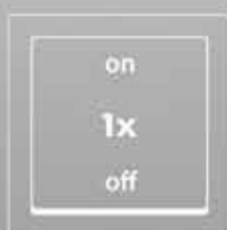

Licht einschalten  
Switch on the light  
Allumer la lumière  
Licht inschakelen  
Encender la luz  
Accendere la luce  
Porniti lumina  
Sytytä valot  
Włączyć światło  
Işığı aç



50%



Licht aus- und sofort wieder einschalten  
Switch off the light and switch it immediately on again  
Éteindre et ré-allumer immédiatement la lumière  
Schakel het licht uit en onmiddellijk weer aan  
Apagar la luz y encenderla inmediatamente  
Spegnere la luce e accenderla immediatamente dopo  
Inchideti lumina si porniti-o din nou imediat  
Sammuta valot ja sytytä välittömästi uudelleen  
Wyłącz światło i natychmiast włącz je ponownie  
Işığı kapatıp, anında tekrar aç



25%





Helligkeit bequem mit jedem herkömmlichen  
Lichtschalter steuern · Adjusting the desired level of brightness

with any conventional light switch · Adapter le niveau d'éclairage avec n'importe quel interrupteur conventionel · Instellen van de gewenste helderheid met elke conventionele schakelaar · Ajuste del nivel de brillo deseado con cualquier interruptor convencional · Variare il livello desiderato di luminosità, con qualsiasi interruttore · Ajustati nivelul dorit de lumina cu orice intrerupator conventional · Valon kirkkauden voi säätää vakiokytkimellä · Komfortowa regulacja jasności przy użyciu dowolnego konwencjonalnego wyłącznika światła · Arzu edilen parlaklık seviyesini herhangi bir anahtar ile ayarlamak







Seite Page	Artikel-Nr. Product No.	EAN-Nummer EAN-Number	incl. 	#	Socket Fitting	Watt Watt	Lumen Lumen	Kelvin Kelvin	EEK (874/2012)	IP IP	Ersatzteile Spare parts
170	100800632	4017807388534		6	E14	max. 28			A++ ... E	IP20	
426	102000403	4017807387919		4	E14	max. 40			A++ ... E	IP20	
426	102000405	4017807387926		4	E14	max. 40			A++ ... E	IP20	
190	110300406	4017807369144		4	E14	max. 28			A++ ... E	IP20	
190	110300428	4017807369151		4	E14	max. 28			A++ ... E	IP20	
428	110400501	4017807255775		5	E14	max. 40			A++ ... E	IP20	
428	110400502	4017807255782		5	E14	max. 40			A++ ... E	IP20	
192	110500328	4017807348620		3	E14	max. 40			A++ ... E	IP20	
192	110500361	4017807348637		3	E14	max. 40			A++ ... E	IP20	
192	110500528	4017807348644		5	E14	max. 40			A++ ... E	IP20	
192	110500561	4017807348651		5	E14	max. 40			A++ ... E	IP20	
430	110600331	4017807343656		3	E14	max. 28			A++ ... E	IP20	92712-01
430	110600378	4017807343663		3	E14	max. 28			A++ ... E	IP20	92712-78
430	110600531	4017807343670		5	E14	max. 28			A++ ... E	IP20	92712-01
430	110600578	4017807343687		5	E14	max. 28			A++ ... E	IP20	92712-78
194	110700328	4017807354140		3	E14	max. 40			A++ ... E	IP20	92809
194	110700361	4017807354157		3	E14	max. 40			A++ ... E	IP20	92809-01
194	110700528	4017807354164		5	E14	max. 40			A++ ... E	IP20	92809
194	110700561	4017807354171		5	E14	max. 40			A++ ... E	IP20	92809-01
244	110900511	4017807349177		5	E14	max. 28			A++ ... E	IP20	
178	118800631	4017807387858		6	E14	max. 40			A++ ... E	IP20	
178	118800632	4017807387865		6	E14	max. 40			A++ ... E	IP20	
194	200700128	4017807354188		1	E14	max. 40			A++ ... E	IP20	92809
194	200700161	4017807354195		1	E14	max. 40			A++ ... E	IP20	92809-01
170	200800132	4017807388497		1	E14	max. 28			A++ ... E	IP20	
378	200970124	4017807211832		1	E14	max. 40			A++ ... E	IP20	92396
258	202200104	4017807292510		1	E14	max. 40			A++ ... E	IP20	
258	202200161	4017807292527		1	E14	max. 40			A++ ... E	IP20	
258	202200162	4017807292534		1	E14	max. 40			A++ ... E	IP20	
331	202400106	4017807244908		1	E14	max. 40			A++ ... E	IP20	92579
162	202500101	4017807364927		1	E27	max. 40			A++ ... E	IP20	92831-20
332	204000106	4017807295672		1	E14	max. 40			A++ ... E	IP20	92769
163	204400101	4017807364972		1	E27	max. 40			A++ ... E	IP20	92830-22
150	204700101	4017807276541		1	E27	max. 60			A++ ... E	IP20	92717-13
342	206400279	4017807364361		2	GU10	max. 35			A++ ... E	IP20	
342	206500279	4017807364378		2	GU10	max. 35			A++ ... E	IP20	
364	206600278	4017807364347		2	GU10	max. 35			A++ ... E	IP20	
210	206870107	4017807387834		1	E27	max. 60			A++ ... E	IP20	
234	207000188	4017807356076		1	E27	max. 60			A++ ... E	IP20	
220	207500179	4017807382860		1	E14	max. 40			A++ ... E	IP20	
220	207500189	4017807382877		1	E14	max. 40			A++ ... E	IP20	
160	207700100	4017807385298		1	E27	max. 40			A++ ... E	IP20	
166	207800100	4017807189148		1	E14	max. 40			A++ ... E	IP20	92259-20
165	208400106	4017807240184		1	E14	max. 40			A++ ... E	IP20	
158	208700179	4017807385342		1	E27	max. 40			A++ ... E	IP20	
158	208700189	4017807385359		1	E27	max. 40			A++ ... E	IP20	
178	208870131	4017807388466		1	E14	max. 40			A++ ... E	IP20	
178	208870132	4017807388473		1	E14	max. 40			A++ ... E	IP20	
212	209100107	4017807398564		1	E27	max. 60			A++ ... E	IP20	
212	209100108	4017807398571		1	E27	max. 60			A++ ... E	IP20	
134	210200101	4017807394702		1	E27	max. 60			A++ ... E	IP20	92754-201
132	210200102	4017807394719		1	E27	max. 60			A++ ... E	IP20	92754-202
190	210370206	4017807369182		2	E14	max. 28			A++ ... E	IP20	
190	210370228	4017807369199		2	E14	max. 28			A++ ... E	IP20	
192	210500228	4017807351194		2	E14	max. 40			A++ ... E	IP20	

Seite Page	Artikel-Nr. Product No.	EAN-Nummer EAN-Number	incl. 	#	Sockel Fitting	Watt Watt	Lumen Lumen	Kelvin Kelvin	EEK (874/2012)	IP IP	Ersatzteile Spare parts
192	210500261	4017807351200		2	E14	max. 40			A++ ... E	IP20	
381	210710107	4017807244953		1	G9	max. 28			A++ ... E	IP20	92580
378	216070107	4017807212198		1	G9	max. 28			A++ ... E	IP20	9797
378	216070124	4017807212228		1	G9	max. 28			A++ ... E	IP20	9797
362	220810201	4017807258363	✓	2	SMD-LED	3,2	300	3000K	A+	IP20	92335
362	220810205	4017807258370	✓	2	SMD-LED	3,2	300	3000K	A+	IP20	92335
358	221570207	4017807281170	✓	2	SMD-LED	3,2	300	3000K	A+	IP20	
358	221570228	4017807281187	✓	2	SMD-LED	3,2	300	3000K	A+	IP20	
354	222270231	4017807387414	✓	1	SMD-LED	5	500	3000K	A+	IP20	
			✓	1	SMD-LED	2,3	200	3000K	A+		
354	222270232	4017807387421	✓	1	SMD-LED	5	500	3000K	A+	IP20	
			✓	2	SMD-LED	2,3	200	3000K	A+		
354	222370231	4017807387025	✓	1	SMD-LED	6	600	3000K	A+	IP20	
			✓	1	SMD-LED	2,3	200	3000K	A+		
354	222370232	4017807387032	✓	1	SMD-LED	6	600	3000K	A+	IP20	
			✓	1	SMD-LED	2,3	200	3000K	A+		
363	222410205	4017807331349	✓	2	SMD-LED	3,8	380	3000K	A+	IP20	
363	222410206	4017807331370	✓	2	SMD-LED	3,8	380	3000K	A+	IP20	
370	222970207	4017807264203	✓	2	SMD-LED	3,2	300	3000K	A+	IP20	
360	223170201	4017807267358	✓	2	SMD-LED	5	450	3000K	A+	IP20	
360	223170207	4017807267372	✓	2	SMD-LED	5	450	3000K	A+	IP20	
368	223210107	4017807386967	✓	1	SMD-LED	6,5	500	3000K	A+	IP20	
368	223210131	4017807386974	✓	1	SMD-LED	6,5	500	3000K	A+	IP20	
368	223210132	4017807386981	✓	1	SMD-LED	6,5	500	3000K	A+	IP20	
368	223210207	4017807386998	✓	1	SMD-LED	13	1000	3000K	A+	IP20	
368	223210231	4017807387001	✓	1	SMD-LED	13	1000	3000K	A+	IP20	
368	223210232	4017807387018	✓	1	SMD-LED	13	1000	3000K	A+	IP20	
361	223310105	4017807371765	✓	1	SMD-LED	4,5	430	3000K	A+	IP20	
361	223310131	4017807371772	✓	1	SMD-LED	4,5	430	3000K	A+	IP20	
361	223310132	4017807371789	✓	1	SMD-LED	4,5	430	3000K	A+	IP20	
359	223410107	4017807303032	✓	1	SMD-LED	4,5	430	3000K	A+	IP20	
359	223410131	4017807303025	✓	1	SMD-LED	4,5	430	3000K	A+	IP20	
359	223410132	4017807306309	✓	1	SMD-LED	4,5	430	3000K	A+	IP20	
342	223810279	4017807299472	✓	1	SMD-LED	3,2	300	3000K	A+	IP20	
			✓	1	SMD-LED	3	200	3000K	A+		
344	224110109	4017807328998	✓	1	SMD-LED	8	700	3000K	A+	IP20	
344	224110179	4017807329018	✓	1	SMD-LED	8	700	3000K	A+	IP20	
344	224110189	4017807329025	✓	1	SMD-LED	8	700	3000K	A+	IP20	
372	225210104	4017807256314	✓	1	SMD-LED	8	600	3000K	A	IP20	
372	225210106	4017807256321	✓	1	SMD-LED	8	600	3000K	A	IP20	
372	225210107	4017807256338	✓	1	SMD-LED	8	600	3000K	A	IP20	
377	225370102	4017807275407	✓	1	SMD-LED	4,5	400	3000K	A+	IP20	
106	225410207	4017807351323	✓	2	SMD-LED	4	360	3000K	A+	IP20	
106	225410208	4017807351330	✓	2	SMD-LED	4	360	3000K	A+	IP20	
365	225510207	4017807277913	✓	2	SMD-LED	3,2	300	3000K	A+	IP20	
365	225610607	4017807277920	✓	6	SMD-LED	1	100	3000K	A++	IP20	
362	225770205	4017807364293	✓	2	SMD-LED	3	280	3000K	A+	IP20	
362	225770206	4017807364668	✓	2	SMD-LED	3	280	3000K	A+	IP20	
366	225870107	4017807385489	✓	1	SMD-LED	6	480	3000K	A+	IP20	
366	225870131	4017807385496	✓	1	SMD-LED	6	480	3000K	A+	IP20	
366	225870132	4017807385502	✓	1	SMD-LED	6	480	3000K	A+	IP20	
306	226811531	4017807359602	✓	1	SMD-LED	16	1500	3000K	A+	IP20	
306	226812031	4017807359619	✓	1	SMD-LED	20	1850	3000K	A+	IP20	
90	227172007	4017807368086	✓	1	SMD-LED	21	2100	3000K	A+	IP20	

Seite Page	Artikel-Nr. Product No.	EAN-Nummer EAN-Number	incl. 	#	Socket Fitting	Watt Watt	Lumen Lumen	Kelvin Kelvin	EEK (874/2012)	IP IP	Ersatzteile Spare parts
498	227280101	4017807298253	✓	1	SMD-LED	5	550	3500K	A+	IP20	
498	227280102	4017807298260	✓	1	SMD-LED	5	550	3500K	A+	IP20	
314	227970106	4017807268997	✓	1	SMD-LED	4,5	400	3000K	A+	IP20	92676-12
314	227970206	4017807266245	✓	2	SMD-LED	4,3	430	3000K	A+	IP20	92676-26
314	227970406	4017807266252	✓	4	SMD-LED	4,5	400	3000K	A+	IP20	92676-45
380	2501021-01	4017807130669		2	E14	max. 40			A++ ... E	IP20	9273-01
378	2502211-07	4017807103908		1	E14	max. 60			A++ ... E	IP20	9413-01
381	2522011-06	4017807080797		1	E14	max. 40			A++ ... E	IP20	92105
381	2523011-01	4017807094756		1	E14	max. 40			A++ ... E	IP20	9327-01
380	2524011-07	4017807067170		1	E27	max. 60			A++ ... E	IP20	9232
379	2529211-24	4017807151084		1	E14	max. 60			A++ ... E	IP20	9573-24
54	254700101	4017807395860	✓	1	E27	11,5	806	RGBW	A	IP20	
364	261100207	4017807351576		2	GU10	max. 35			A++ ... E	IP20	
198	2670911-24	4017807213232		1	G9	max. 28			A++ ... E	IP20	92379
82	270970106	4017807330625	✓	1	SMD-LED	4,2	450	3000K	A+	IP20	
218	271170201	4017807247251		1	E14	max. 40			A++ ... E	IP20	92765-01
			✓	1	SMD-LED	3,2	300	3000K	A+		
218	271170202	4017807247268		1	E14	max. 40			A++ ... E	IP20	92765-02
			✓	1	SMD-LED	3,2	300	3000K	A+		
218	271170214	4017807247282		1	E14	max. 40			A++ ... E	IP20	
			✓	1	SMD-LED	3,2	300	3000K	A+		
218	271370201	4017807358339		1	E14	max. 40			A++ ... E	IP20	
			✓	1	SMD-LED	3,2	300	3000K	A+		
218	271370211	4017807358346		1	E14	max. 40			A++ ... E	IP20	
			✓	1	SMD-LED	3,2	300	3000K	A+		
218	271370214	4017807358353		1	E14	max. 40			A++ ... E	IP20	
			✓	1	SMD-LED	3,2	300	3000K	A+		
356	271470207	4017807374681		1	E27	max. 40			A++ ... E	IP20	
			✓	1	SMD-LED	3,1	310	3000K	A+		
356	271470279	4017807374698		1	E27	max. 40			A++ ... E	IP20	
			✓	1	SMD-LED	3,1	310	3000K	A+		
204	271970601	4017807337280	✓	1	SMD-LED	6	580	3000K	A+	IP20	
204	271970611	4017807337297	✓	1	SMD-LED	6	580	3000K	A+	IP20	
206	271970679	4017807337303	✓	1	SMD-LED	6	580	3000K	A+	IP20	
206	271970689	4017807337310	✓	1	SMD-LED	6	580	3000K	A+	IP20	
110	272470107	4017807358360	✓	1	SMD-LED	6	560	3000K	A+	IP20	
110	272470108	4017807358377	✓	1	SMD-LED	6	560	3000K	A+	IP20	
116	272510806	4017807352818	✓	8	SMD-LED	2,3	240	3000K	A++	IP20	92805
116	272570206	4017807352788	✓	2	SMD-LED	2,3	240	3000K	A++	IP20	92805
116	272570406	4017807352795	✓	4	SMD-LED	2,3	240	3000K	A++	IP20	92805
116	272570606	4017807352801	✓	6	SMD-LED	2,3	240	3000K	A++	IP20	92805
387	272970401	4017807284652	✓	1	SMD-LED	4	350	3000K	A+	IP20	
387	272970487	4017807284669	✓	1	SMD-LED	4	350	3000K	A+	IP20	
387	272970701	4017807284676	✓	1	SMD-LED	7	600	3000K	A+	IP20	
387	272970787	4017807284683	✓	1	SMD-LED	7	600	3000K	A+	IP20	
388	273070401	4017807284690	✓	1	SMD-LED	4	350	3000K	A+	IP20	
388	273070701	4017807284706	✓	1	SMD-LED	7	600	3000K	A+	IP20	
388	273071301	4017807284713	✓	1	SMD-LED	13	1100	3000K	A	IP20	
388	273071801	4017807284720	✓	1	SMD-LED	18	1500	3000K	A	IP20	
387	273170301	4017807284737	✓	3	SMD-LED	1	80	3000K	A++	IP20	
387	273170387	4017807284744	✓	3	SMD-LED	1	80	3000K	A++	IP20	
387	273170401	4017807284751	✓	4	SMD-LED	1	80	3000K	A++	IP20	
387	273170487	4017807284768	✓	4	SMD-LED	1	80	3000K	A++	IP20	
385	273271201	4017807329087	✓	1	SMD-LED	10	850	3000K	A+	IP20	
385	273271801	4017807329094	✓	1	SMD-LED	15,5	1300	3000K	A+	IP20	

Seite Page	Artikel-Nr. Product No.	EAN-Nummer EAN-Number	incl. 	#	Socket Fitting	Watt Watt	Lumen Lumen	Kelvin Kelvin	EEK (874/2012)	IP IP	Ersatzteile Spare parts
389	273370307	4017807284799	✓	3	SMD-LED	3	200	3000K	A+	IP20	
94	274191005	4017807281927	✓	1	SMD-LED	10	900	3000K	A	IP20	
274	274510107	4017807381559	✓	1	SMD-LED	20	2100	3000 + 5000K	A+	IP20	
371	274670105	4017807293968	✓	1	SMD-LED	4,5	430	3000K	A+	IP20	
371	274670205	4017807293975	✓	2	SMD-LED	4,5	430	3000K	A+	IP20	
371	274670305	4017807293982	✓	3	SMD-LED	4,5	430	3000K	A+	IP20	
108	274770107	4017807390049	✓	1	SMD-LED	8	750	3000K	A+	IP20	
108	274770132	4017807390056	✓	1	SMD-LED	8	750	3000K	A+	IP20	
112	275190131	4017807390278	✓	1	SMD-LED	8,5	830	3000K	A+	IP20	
300	276210207	4017807371895	✓	1	SMD-LED	20	1450	3000K	A+	IP20	
300	276290107	4017807371901	✓	1	SMD-LED	15,5	1250	3000K	A+	IP20	
84	276370206	4017807298895	✓	2	SMD-LED	8	800	3000K	A+	IP20	
66	277690206	4017807282153	✓	2	SMD-LED	5	500	3000K	A+	IP20	
370	279670207	4017807286878	✓	2	SMD-LED	4,3	460	3000K	A+	IP20	
374	279770104	4017807275346	✓	1	SMD-LED	4	380	3000K	A++	IP20	
374	279770107	4017807275353	✓	1	SMD-LED	4	380	3000K	A++	IP20	
374	279770108	4017807275360	✓	1	SMD-LED	4	380	3000K	A++	IP20	
596	2803021-06	4017807147599		2	E14	max. 40			A++ ... E	IP21	9579-01
596	2803031-06	4017807147605		3	E14	max. 40			A++ ... E	IP21	9579
594	281570606	4017807245967	✓	1	SMD-LED	6	600	3000K	A+	IP44	
594	281570906	4017807245950	✓	1	SMD-LED	9	970	3000K	A+	IP44	
593	281670206	4017807245974	✓	2	SMD-LED	6	600	3000K	A+	IP44	
593	281670207	4017807245981	✓	2	SMD-LED	6	600	3000K	A+	IP44	
594	281770906	4017807246018	✓	1	SMD-LED	9	900	3000K	A++	IP44	
594	281771206	4017807246025	✓	1	SMD-LED	12	1200	3000K	A++	IP44	
593	282210106	4017807245998	✓	1	SMD-LED	2,3	230	3000K	A++	IP44	
593	282210107	4017807246063	✓	1	SMD-LED	2,2	220	3000K	A++	IP44	
586	282310106	4017807280791	✓	1	SMD-LED	3,2	300	3000K	A+	IP44	92736
586	282310206	4017807280807	✓	2	SMD-LED	3,2	300	3000K	A+	IP44	92736
588	282410106	4017807280821	✓	1	SMD-LED	3,2	300	3000K	A+	IP44	
588	282410206	4017807280838	✓	2	SMD-LED	3,2	300	3000K	A+	IP44	
589	282510106	4017807302998	✓	1	SMD-LED	4,5	430	3000K	A+	IP44	
589	282510206	4017807303001	✓	2	SMD-LED	4,5	430	3000K	A+	IP44	
587	282710106	4017807302530	✓	1	SMD-LED	3,6	260	3000K	A+	IP44	
587	282710206	4017807302547	✓	2	SMD-LED	2,8	180	3000K	A+	IP44	
592	282990106	4017807345070	✓	1	SMD-LED	3	280	3000K	A+	IP44	
592	283090106	4017807345087	✓	1	SMD-LED	3	280	3000K	A+	IP44	
591	283110106	4017807382846	✓	1	SMD-LED	4	340	3000K	A+	IP44	
591	283110206	4017807382853	✓	2	SMD-LED	4	340	3000K	A+	IP44	
597	283270106	4017807384048	✓	1	SMD-LED	4,3	450	3000K	A+	IP44	
597	283270206	4017807384055	✓	1	SMD-LED	6,5	680	3000K	A+	IP44	
597	283270306	4017807384062	✓	1	SMD-LED	8,6	880	3000K	A+	IP44	
590	283370106	4017807391824	✓	1	SMD-LED	4,3	430	3000K	A+	IP44	
590	283370107	4017807384185	✓	1	SMD-LED	4,3	430	3000K	A+	IP44	
590	283370206	4017807395198	✓	2	SMD-LED	4,3	430	3000K	A+	IP44	
590	283370207	4017807395204	✓	2	SMD-LED	4,3	430	3000K	A+	IP44	
420	300203005	4017807203271		1	E27	max. 60			A++ ... E	IP20	
408	300300132	4017807334883		1	E27	max. 60			A++ ... E	IP20	
186	300500104	4017807267112		1	E27	max. 60			A++ ... E	IP20	
186	300500107	4017807262421		1	E27	max. 60			A++ ... E	IP20	
186	300500109	4017807262438		1	E27	max. 60			A++ ... E	IP20	
255	300700101	4017807298659		1	E27	max. 60			A++ ... E	IP20	
255	300700102	4017807298666		1	E27	max. 60			A++ ... E	IP20	
172	300800132	4017807388541		1	E14	max. 28			A++ ... E	IP20	
172	300800432	4017807388558		4	E14	max. 28			A++ ... E	IP20	

Seite Page	Artikel-Nr. Product No.	EAN-Nummer EAN-Number	incl. 	#	Sockel Fitting	Watt Watt	Lumen Lumen	Kelvin Kelvin	EEK (874/2012)	IP IP	Ersatzteile Spare parts
255	300900101	4017807298673		1	E27	max. 60			A++ ... E	IP20	
255	300900102	4017807298680		1	E27	max. 60			A++ ... E	IP20	
416	301100178	4017807293500		1	E14	max. 40			A++ ... E	IP20	
416	301100378	4017807293517		3	E14	max. 40			A++ ... E	IP20	
416	301190178	4017807293524		1	E27	max. 60			A++ ... E	IP20	
410	301300142	4017807390322		1	E27	max. 42			A++ ... E	IP20	
410	301300342	4017807390346		3	E27	max. 42			A++ ... E	IP20	
410	301300442	4017807390353		4	E27	max. 42			A++ ... E	IP20	
440	301400101	4017807195422		1	E27	max. 60			A++ ... E	IP20	92270-01
440	301400112	4017807195446		1	E27	max. 60			A++ ... E	IP20	92270-12
440	301400115	4017807195453		1	E27	max. 60			A++ ... E	IP20	92270-15
440	301400124	4017807195651		1	E27	max. 60			A++ ... E	IP20	92270-24
154	301500407	4017807388886		4	E14	max. 28			A++ ... E	IP20	
148	301600106	4017807343816		1	E27	max. 60			A++ ... E	IP20	
148	301600107	4017807343809		1	E27	max. 60			A++ ... E	IP20	
148	301690106	4017807349184		1	E27	max. 60			A++ ... E	IP20	92810
148	301690107	4017807349191		1	E27	max. 60			A++ ... E	IP20	92810-01
437	301700107	4017807196009		1	E27	max. 60			A++ ... E	IP20	9408-01
437	301700108	4017807196016		1	E27	max. 60			A++ ... E	IP20	9408-01
413	301800107	4017807262537		1	E27	max. 60			A++ ... E	IP20	92700
413	301800129	4017807282740		1	E27	max. 60			A++ ... E	IP20	92700
436	301900104	4017807299304		1	E27	max. 60			A++ ... E	IP20	92295
436	301900107	4017807299311		1	E27	max. 60			A++ ... E	IP20	92295
436	301900162	4017807303209		1	E27	max. 60			A++ ... E	IP20	92295
258	302200104	4017807292541		1	E27	max. 40			A++ ... E	IP20	
258	302200161	4017807292558		1	E27	max. 40			A++ ... E	IP20	
258	302200162	4017807292565		1	E27	max. 40			A++ ... E	IP20	
440	302400106	4017807301045		1	E27	max. 40			A++ ... E	IP20	92780
162	302500301	4017807364934		3	E27	max. 40			A++ ... E	IP20	
247	302600161	4017807286786		1	E27	max. 60			A++ ... E	IP20	92752
247	302600162	4017807286793		1	E27	max. 60			A++ ... E	IP20	92752
250	302700102	4017807286526		1	E14	max. 40			A++ ... E	IP20	
253	302900102	4017807292497		1	E27	max. 60			A++ ... E	IP20	92779
152	303000189	4017807337457		1	E27	max. 60			A++ ... E	IP20	92811
157	303100104	4017807353310		1	E27	max. 60			A++ ... E	IP20	92812
157	303100107	4017807353327		1	E27	max. 60			A++ ... E	IP20	92812
215	303300101	4017807288292		1	E27	max. 60			A++ ... E	IP20	
215	303300102	4017807288308		1	E27	max. 60			A++ ... E	IP20	
215	303300114	4017807288315		1	E27	max. 60			A++ ... E	IP20	92837-14
215	303300301	4017807242485		3	E27	max. 60			A++ ... E	IP20	92722
215	303300302	4017807242492		3	E27	max. 60			A++ ... E	IP20	92722-02
215	303300314	4017807244410		3	E27	max. 60			A++ ... E	IP20	92722-14
261	303700104	4017807286601		1	E14	max. 40			A++ ... E	IP20	
261	303700161	4017807286618		1	E14	max. 40			A++ ... E	IP20	
261	303700162	4017807286625		1	E14	max. 40			A++ ... E	IP20	
248	303800102	4017807286540		1	E14	max. 40			A++ ... E	IP20	92740
248	303800161	4017807286557		1	E14	max. 40			A++ ... E	IP20	92740
248	303800162	4017807286564		1	E14	max. 40			A++ ... E	IP20	92740
249	303800517	4017807292503		5	E14	max. 40			A++ ... E	IP20	92740
438	303900100	4017807227604		1	E27	max. 40			A++ ... E	IP20	
441	304000106	4017807216448		1	E27	max. 60			A++ ... E	IP21	92391
441	304100100	4017807247411		1	E27	max. 60			A++ ... E	IP20	
441	304100106	4017807247404		1	E27	max. 60			A++ ... E	IP20	
441	304100192	4017807247428		1	E27	max. 60			A++ ... E	IP20	
438	304200100	4017807290332		1	E27	max. 40			A++ ... E	IP20	

Seite Page	Artikel-Nr. Product No.	EAN-Nummer EAN-Number	incl. 	#	Sockel Fitting	Watt Watt	Lumen Lumen	Kelvin Kelvin	EEK (874/2012)	IP IP	Ersatzteile Spare parts
438	304290100	4017807290363		1	E27	max. 60			A++ ... E	IP20	
163	304400201	4017807364989		2	E27	max. 40			A++ ... E	IP20	92830-040
246	304500104	4017807286151		1	E27	max. 28			A++ ... E	IP20	92740
246	304500161	4017807286168		1	E27	max. 28			A++ ... E	IP20	92740
246	304500162	4017807286175		1	E27	max. 28			A++ ... E	IP20	92740
176	304600531	4017807374841		5	G9	max. 28			A++ ... E	IP20	
176	304600532	4017807374858		5	G9	max. 28			A++ ... E	IP20	
150	304700101	4017807275667		1	E27	max. 60			A++ ... E	IP20	92717-17
150	304700301	4017807275681		3	E27	max. 60			A++ ... E	IP20	92717-17
150	304790101	4017807275674		1	E27	max. 60			A++ ... E	IP20	92717-23
423	304800100	4017807277937		1	E27	max. 60			A++ ... E	IP20	92720-00
423	304800142	4017807277944		1	E27	max. 60			A++ ... E	IP20	92720-42
422	304900100	4017807277951		1	E27	max. 60			A++ ... E	IP20	92721-00
422	304900142	4017807277968		1	E27	max. 60			A++ ... E	IP20	92721-42
230	305000101	4017807369342		1	E27	max. 40			A++ ... E	IP20	
230	305000111	4017807369359		1	E27	max. 40			A++ ... E	IP20	
241	305000430	4017807353792		4	E14	max. 28			A++ ... E	IP20	
257	305100161	4017807330533		1	E27	max. 60			A++ ... E	IP20	
257	305100162	4017807330540		1	E27	max. 60			A++ ... E	IP20	
146	305200179	4017807281064		1	E27	max. 60			A++ ... E	IP20	92728-79
146	305200189	4017807281071		1	E27	max. 60			A++ ... E	IP20	92728-89
146	305200379	4017807287066		3	E14	max. 40			A++ ... E	IP20	92727-79
146	305200389	4017807287073		3	E14	max. 40			A++ ... E	IP20	92727-89
146	305290179	4017807287042		1	E14	max. 40			A++ ... E	IP20	92727-79
146	305290189	4017807287059		1	E14	max. 40			A++ ... E	IP20	92727-89
226	305400401	4017807336948		4	E14	max. 40			A++ ... E	IP20	
226	305400411	4017807336955		4	E14	max. 40			A++ ... E	IP20	
224	305400441	4017807391022		4	E14	max. 40			A++ ... E	IP20	
226	305400479	4017807336962		4	E14	max. 40			A++ ... E	IP20	
226	305400489	4017807336979		4	E14	max. 40			A++ ... E	IP20	
412	305700109	4017807329131		1	E27	max. 60			A++ ... E	IP20	
412	305700179	4017807329148		1	E27	max. 60			A++ ... E	IP20	
412	305700189	4017807329155		1	E27	max. 60			A++ ... E	IP20	
126	305800506	4017807377446		5	G9	max. 28			A++ ... E	IP20	
424	305900126	4017807330816		1	E27	max. 60			A++ ... E	IP20	
424	305900130	4017807330809		1	E27	max. 60			A++ ... E	IP20	
188	306000107	4017807374643		1	E27	max. 42			A++ ... E	IP20	
188	306000131	4017807374629		1	E27	max. 42			A++ ... E	IP20	
188	306000132	4017807374636		1	E27	max. 42			A++ ... E	IP20	
138	306100131	4017807355772		1	E27	max. 40			A++ ... E	IP20	92749-331
136	306100132	4017807355789		1	E27	max. 40			A++ ... E	IP20	92749-332
184	306100178	4017807355987		1	E27	max. 60			A++ ... E	IP20	
184	306100378	4017807358704		3	E27	max. 60			A++ ... E	IP20	
138	306190131	4017807355802		1	E27	max. 60			A++ ... E	IP20	92749-531
136	306190132	4017807355819		1	E27	max. 60			A++ ... E	IP20	92749-532
420	306200101	4017807280869		1	E27	max. 40			A++ ... E	IP20	
420	306200105	4017807280876		1	E27	max. 40			A++ ... E	IP20	
421	306300101	4017807280883		1	E27	max. 60			A++ ... E	IP20	
421	306300105	4017807280890		1	E27	max. 60			A++ ... E	IP20	
408	306400179	4017807286465		1	E14	max. 40			A++ ... E	IP20	
222	306500107	4017807280975		1	E27	max. 60			A++ ... E	IP20	
231	306600101	4017807334920		1	E27	max. 60			A++ ... E	IP20	
153	306700106	4017807356144		1	E27	max. 60			A++ ... E	IP20	
174	306700632	4017807364392		6	E27	max. 28			A++ ... E	IP20	
174	306700732	4017807399905		7	E27	max. 60			A++ ... E	IP20	

Seite Page	Artikel-Nr. Product No.	EAN-Nummer EAN-Number	incl. 	#	Sockel Fitting	Watt Watt	Lumen Lumen	Kelvin Kelvin	EEK (874/2012)	IP IP	Ersatzteile Spare parts
210	306800107	4017807387759		1	E27	max. 60			A++ ... E	IP20	
208	306800307	4017807387766		3	E27	max. 60			A++ ... E	IP20	
256	306900161	4017807351767		1	E27	max. 60			A++ ... E	IP20	
256	306900162	4017807356816		1	E27	max. 60			A++ ... E	IP20	
234	307000188	4017807356090		1	E27	max. 60			A++ ... E	IP20	
234	307000688	4017807356106		6	E27	max. 60			A++ ... E	IP20	
439	307200101	4017807343731		1	E14	max. 25			A++ ... E	IP20	
439	307290101	4017807343748		1	E27	max. 40			A++ ... E	IP20	
220	307500179	4017807382884		1	E27	max. 60			A++ ... E	IP20	
220	307500189	4017807382891		1	E27	max. 60			A++ ... E	IP20	
220	307500279	4017807395303		2	E27	max. 60			A++ ... E	IP20	
220	307500289	4017807395341		2	E27	max. 60			A++ ... E	IP20	
160	307700300	4017807385304		3	E27	max. 40			A++ ... E	IP20	
414	307700307	4017807383508		3	E27	max. 42			A++ ... E	IP20	
414	307700331	4017807383515		3	E27	max. 42			A++ ... E	IP20	
414	307700378	4017807383522		3	E27	max. 42			A++ ... E	IP20	
166	307800100	4017807189155		1	E27	max. 60			A++ ... E	IP20	92258-30
166	307804100	4017807190083		1	E27	max. 60			A++ ... E	IP20	92258-40
166	307900100	4017807285468		1	E27	max. 60			A++ ... E	IP20	
408	308000132	4017807288827		1	E27	max. 60			A++ ... E	IP20	
228	308200179	4017807392517		1	E27	max. 60			A++ ... E	IP20	
228	308200189	4017807392524		1	E27	max. 60			A++ ... E	IP20	
165	308400206	4017807240191		2	E14	max. 40			A++ ... E	IP20	
429	308600706	4017807378306		7	E14	max. 28			A++ ... E	IP20	B3086-00
158	308700179	4017807385366		1	E27	max. 40			A++ ... E	IP20	
158	308700189	4017807385373		1	E27	max. 40			A++ ... E	IP20	
158	308700279	4017807385380		2	E27	max. 40			A++ ... E	IP20	
158	308700289	4017807385397		2	E27	max. 40			A++ ... E	IP20	
158	308700379	4017807385403		3	E27	max. 40			A++ ... E	IP20	
158	308700389	4017807385410		3	E27	max. 40			A++ ... E	IP20	
140	308800131	4017807394665		1	E27	max. 60			A++ ... E	IP20	92752-4031
140	308800132	4017807394672		1	E27	max. 60			A++ ... E	IP20	92752-4032
140	308890131	4017807394689		1	E27	max. 60			A++ ... E	IP20	92752-5531
140	308890132	4017807394696		1	E27	max. 60			A++ ... E	IP20	92752-5532
425	309200632	4017807383478		6	E27	max. 42			A++ ... E	IP20	
180	309300301	4017807354058		3	E14	max. 40			A++ ... E	IP20	
180	309300302	4017807354102		3	E14	max. 40			A++ ... E	IP20	
432	309700106	4017807196467		1	E27	max. 60			A++ ... E	IP20	
182	309800431	4017807387681		4	E27	max. 40			A++ ... E	IP20	
182	309800432	4017807387698		4	E27	max. 40			A++ ... E	IP20	
168	309900631	4017807330946		6	E14	max. 40			A++ ... E	IP20	
168	309900632	4017807330953		6	E14	max. 40			A++ ... E	IP20	
238	310100107	4017807395259		1	E27	max. 60			A++ ... E	IP20	
238	310100108	4017807395266		1	E27	max. 60			A++ ... E	IP20	
238	310100161	4017807356014		1	E27	max. 60			A++ ... E	IP20	
238	310100162	4017807356021		1	E27	max. 60			A++ ... E	IP20	
238	310100561	4017807356038		5	E27	max. 60			A++ ... E	IP20	
238	310100562	4017807356045		5	E27	max. 60			A++ ... E	IP20	
134	310200101	4017807394726		1	E27	max. 60			A++ ... E	IP20	92754-301
132	310200102	4017807394733		1	E27	max. 60			A++ ... E	IP20	92754-302
134	310290101	4017807394740		1	E27	max. 60			A++ ... E	IP20	92754-501
132	310290102	4017807394757		1	E27	max. 60			A++ ... E	IP20	92754-502
244	310900111	4017807349160		1	E27	max. 42			A++ ... E	IP20	
130	311210506	4017807367768		5	G9	max. 42			A++ ... E	IP20	92829-40
130	311210606	4017807367775		6	G9	max. 42			A++ ... E	IP20	92829-50

Seite Page	Artikel-Nr. Product No.	EAN-Nummer EAN-Number	incl. 	#	Sockel Fitting	Watt Watt	Lumen Lumen	Kelvin Kelvin	EEK (874/2012)	IP IP	Ersatzteile Spare parts
128	311300606	4017807368031		6	G9	max. 33			A++ ... E	IP20	
128	311300806	4017807368048		8	G9	max. 33			A++ ... E	IP20	
144	315200109	4017807288001		1	E27	max. 60			A++ ... E	IP20	92735-09
144	315200179	4017807287998		1	E27	max. 60			A++ ... E	IP20	92735-79
144	315200189	4017807288018		1	E27	max. 60			A++ ... E	IP20	92735-89
142	315300106	4017807301212		1	E27	max. 60			A++ ... E	IP20	92737-01
142	315390106	4017807301205		1	E14	max. 40			A++ ... E	IP20	92736-01
62	320113061	4017807330724	✓	1	SMD-LED	19	1700	3000K	A+	IP20	
62	320114061	4017807330748	✓	1	SMD-LED	22,5	2000	3000K	A+	IP20	
202	320910101	4017807330823	✓	1	SMD-LED	18	1500	3000K	A	IP20	
202	320910111	4017807337181	✓	1	SMD-LED	18	1500	3000K	A	IP20	
206	320910179	4017807330830	✓	1	SMD-LED	18	1500	3000K	A	IP20	
206	320910189	4017807330854	✓	1	SMD-LED	18	1500	3000K	A	IP20	
88	323012407	4017807367621	✓	1	SMD-LED	24,3	2200	3000K	A+	IP20	
343	323810179	4017807305869	✓	1	SMD-LED	19	1700	3000K	A+	IP20	
406	324390407	4017807292701	✓	4	SMD-LED	4,5	430	3000K	A+	IP20	92439
406	324390408	4017807297997	✓	4	SMD-LED	4,5	430	3000K	A+	IP20	92439
556	324810407	4017807257649	✓	4	E14	4	320	3000K	A+	IP20	98249 98248
556	324810428	4017807257854	✓	4	E14	4	320	3000K	A+	IP20	98249 98248
124	325113005	4017807292817	✓	1	SMD-LED	8	650	3000K	A	IP20	
124	325114005	4017807296938	✓	1	SMD-LED	10,5	800	3000K	A	IP20	
104	325310107	4017807367546	✓	1	SMD-LED	34	3600	3000K	A+	IP20	92827-01 92827-02
102	325310207	4017807367553	✓	2	SMD-LED	6,5	650	3000K	A+	IP20	92828
104	325310307	4017807367560	✓	3	SMD-LED	6,5	650	3000K	A+	IP20	92828
102	325330307	4017807368369	✓	3	SMD-LED	6,5	650	3000K	A+	IP20	92828
106	325410807	4017807351361	✓	8	SMD-LED	4	360	3000K	A+	IP20	
106	325410808	4017807351378	✓	8	SMD-LED	4	360	3000K	A+	IP20	
100	325510407	4017807367973	✓	4	SMD-LED	6	630	3000K	A+	IP20	92833
100	325510507	4017807367980	✓	5	SMD-LED	6	630	3000K	A+	IP20	92833
392	325610305	4017807388022	✓	1	SMD-LED	64	6000	3000K	A+	IP20	
90	327113407	4017807368093	✓	1	SMD-LED	30	3200	3000K	A+	IP20	
90	327114807	4017807368109	✓	1	SMD-LED	40	4300	3000K	A+	IP20	
400	327910105	4017807251036	✓	1	COB-LED	4,5	350	3000K	A+	IP20	
400	327910205	4017807245639	✓	2	COB-LED	4,5	350	3000K	A+	IP20	
545	328210406	4017807256352	✓	4	SMD-LED	3,8	350	3100K	A+	IP20	
433	340100106	4017807244434		1	E27	max. 40			A++ ... E	IP20	92591
251	340100127	4017807334449		1	E27	max. 60			A++ ... E	IP20	92814
251	340100162	4017807334456		1	E27	max. 60			A++ ... E	IP20	92814-01
164	3401011-07	4017807057690		1	E27	max. 60			A++ ... E	IP20	9242
433	340190106	4017807246902		1	E27	max. 60			A++ ... E	IP20	92591-28
196	3402011-24	4017807053265		1	E27	max. 60			A++ ... E	IP20	92125
196	3402021-24	4017807196795		2	E27	max. 60			A++ ... E	IP20	92275
437	3407011-07	4017807103724		1	E27	max. 60			A++ ... E	IP20	9408-01
442	3490400-00	4017807062465		1	E27	max. 60			A++ ... E	IP20	
442	3490400-15	4017807254723		1	E27	max. 60			A++ ... E	IP20	
442	3490400-18	4017807081527		1	E27	max. 60			A++ ... E	IP20	
442	3490400-19	4017807254716		1	E27	max. 60			A++ ... E	IP20	
442	3490400-92	4017807198638		1	E27	max. 60			A++ ... E	IP20	
442	3490500-00	4017807062472		1	E27	max. 60			A++ ... E	IP20	
442	3490600-00	4017807062489		1	E27	max. 60			A++ ... E	IP20	
442	3491400-00	4017807081541		1	E27	max. 60			A++ ... E	IP20	
52	351610107	4017807389807	✓	1	E27	11,5	806	RGBW	A	IP20	





Seite Page	Artikel-Nr. Product No.	EAN-Nummer EAN-Number	incl. 	#	Socket Fitting	Watt Watt	Lumen Lumen	Kelvin Kelvin	EEK (874/2012)	IP IP	Ersatzteile Spare parts
52	351690107	4017807389814	✓	1	E27	11,5	806	RGBW	A	IP20	
54	354790101	4017807395884	✓	1	E27	11,5	806	RGBW	A	IP20	
48	358210107	4017807389784	✓	1	SMD-LED	20	2000	RGBW	A+	IP20	
48	358210131	4017807389791	✓	1	SMD-LED	20	2000	RGBW	A+	IP20	
442	3590010-01	4017807062496		1	E27	max. 60			A++ ... E	IP20	
99	370090106	4017807369267	✓	1	SMD-LED	28	3000	3000 + 5000K	A+	IP20	
74	370110307	4017807343649	✓	3	SMD-LED	12	1050	3000K	A+	IP20	
68	370610407	4017807299687	✓	4	SMD-LED	4,5	430	3000K	A+	IP20	
82	370910606	4017807330670	✓	6	SMD-LED	4,2	450	3000K	A+	IP20	
555	371010307	4017807281750	✓	3	E14	5	400	3000K	A+	IP20	92734-01
555	371010308	4017807281767	✓	3	E14	5	400	3000K	A+	IP20	92734-01
555	371010407	4017807281781	✓	4	E14	5	400	3000K	A+	IP20	92734-01
555	371010408	4017807281798	✓	4	E14	5	400	3000K	A+	IP20	92734-01
558	371410407	4017807261875	✓	4	E14	4	320	3000K	A+	IP20	92680
551	371510407	4017807285017	✓	4	G9	3,5	300	3000K	A+	IP20	92739
551	371510408	4017807301267	✓	4	G9	3,5	300	3000K	A+	IP20	92739
64	371610307	4017807391275	✓	3	SMD-LED	8,5	950	3000K	A+	IP20	
64	371610331	4017807391282	✓	3	SMD-LED	8,5	950	3000K	A+	IP20	
64	371690307	4017807391251	✓	3	SMD-LED	7,5	830	3000K	A+	IP20	
64	371690331	4017807391268	✓	3	SMD-LED	7,5	830	3000K	A+	IP20	
114	372110507	4017807338393	✓	5	SMD-LED	4,3	400	3000K	A+	IP20	
72	372294505	4017807297546	✓	1	SMD-LED	45	4500	3000K	A+	IP20	
116	372510806	4017807352832	✓	8	SMD-LED	2,3	240	3000K	A++	IP20	92805
58	372610331	4017807377460	✓	1	SMD-LED	26	2200	3000K	A	IP20	
547	372810406	4017807262353	✓	4	SMD-LED	3,8	350	3100K	A+	IP20	
547	372810506	4017807266276	✓	5	SMD-LED	3,8	350	3100K	A+	IP20	
92	372910106	4017807299267	✓	1	SMD-LED	20	1800	3000K	A+	IP20	
402	373710207	4017807385205	✓	1	SMD-LED	26	3000	3000K	A+	IP20	
402	373710231	4017807385212	✓	1	SMD-LED	26	3000	3000K	A+	IP20	
402	373710232	4017807385229	✓	1	SMD-LED	26	3000	3000K	A+	IP20	
402	373790207	4017807385267	✓	1	SMD-LED	37	4500	3000K	A+	IP20	
402	373790231	4017807385274	✓	1	SMD-LED	37	4500	3000K	A+	IP20	
402	373790232	4017807385281	✓	1	SMD-LED	37	4500	3000K	A+	IP20	
94	374112505	4017807281934	✓	1	SMD-LED	25	2300	3000K	A	IP20	
398	374210406	4017807288391	✓	4	SMD-LED	3,5	370	3000K	A++	IP20	
404	374810107	4017807385175	✓	1	SMD-LED	38	4200	3000K	A+	IP20	
404	374810131	4017807385182	✓	1	SMD-LED	38	4200	3000K	A+	IP20	
404	374810132	4017807385199	✓	1	SMD-LED	38	4200	3000K	A+	IP20	
97	374910106	4017807306019	✓	1	SMD-LED	30	2200	3000+		A	IP20
							4400+6700K				
434	3751021-07	4017807137712		2	E14	max. 40			A++ ... E	IP20	9350
434	3751031-07	4017807137729		3	E14	max. 40			A++ ... E	IP20	9350
434	3751031-24	4017807182255		3	E14	max. 40			A++ ... E	IP20	9350-24
434	3751041-07	4017807137736		4	E14	max. 40			A++ ... E	IP20	9350
434	3751041-24	4017807181081		4	E14	max. 40			A++ ... E	IP20	9350-24
434	3751051-07	4017807169027		5	E14	max. 40			A++ ... E	IP20	9350
434	3751051-24	4017807181098		5	E14	max. 40			A++ ... E	IP20	9350-24
395	376013606	4017807282085	✓	1	SMD-LED	36	3500	3000K	A+	IP20	
118	376110106	4017807336924	✓	1	SMD-LED	30	2650	3000K	A+	IP20	
118	376110131	4017807336931	✓	1	SMD-LED	30	2650	3000K	A+	IP20	
84	376310406	4017807298918	✓	4	SMD-LED	7	700	3000K	A+	IP20	
409	376410402	4017807280906	✓	4	SMD-LED	4,3	430	3000K	A+	IP20	
407	376790528	4017807281057	✓	5	SMD-LED	4,5	430	3000K	A+	IP20	
399	377310307	4017807274622	✓	3	SMD-LED	4,5	430	3000K	A+	IP20	92707
394	377590205	4017807293937	✓	1	SMD-LED	30	2800	3000K	A	IP20	

Seite Page	Artikel-Nr. Product No.	EAN-Nummer EAN-Number	incl. 	#	Socket Fitting	Watt Watt	Lumen Lumen	Kelvin Kelvin	EEK (874/2012)	IP IP	Ersatzteile Spare parts
66	377610106	4017807282160	✓	1	SMD-LED	24	2200	3000K	A+	IP20	
405	377690105	4017807296280	✓	1	SMD-LED	20	1900	3000K	A+	IP20	
200	378010307	4017807391152	✓	3	SMD-LED	7,5	750	3000K	A+	IP20	
200	378010308	4017807391169	✓	3	SMD-LED	7,5	750	3000K	A+	IP20	
200	378010407	4017807391176	✓	4	SMD-LED	7,5	750	3000K	A+	IP20	
200	378010408	4017807391183	✓	4	SMD-LED	7,5	750	3000K	A+	IP20	
120	378310106	4017807336788	✓	1	SMD-LED	22	2000	3000K	A	IP20	
122	378310406	4017807336771	✓	4	SMD-LED	3,8	350	3000K	A+	IP20	
78	378490607	4017807281293	✓	6	SMD-LED	4,5	430	3000K	A+	IP20	
401	379090505	4017807282245	✓	5	SMD-LED	4,5	430	3000K	A+	IP20	
76	379190707	4017807362831	✓	7	SMD-LED	3,5	350 3000 + 5000K		A+	IP20	
76	379190779	4017807370829	✓	7	SMD-LED	3,5	350 3000 + 5000K		A+	IP20	
80	379890307	4017807372984	✓	3	SMD-LED	9	850 3000 + 5000K		A+	IP20	
60	379910105	4017807390100	✓	1	SMD-LED	30	3000	3000K	A+	IP20	
450	400200107	4017807368390		1	E27	max. 60			A++ ... E	IP20	92820
450	400200108	4017807378320		1	E27	max. 60			A++ ... E	IP20	92820-08
186	400500104	4017807268621		1	E14	max. 18			A++ ... E	IP20	
186	400500107	4017807268638		1	E14	max. 18			A++ ... E	IP20	
186	400500109	4017807268645		1	E14	max. 18			A++ ... E	IP20	
172	400800132	4017807388510		1	E14	max. 28			A++ ... E	IP20	
215	401100101	4017807276121		1	E27	max. 60			A++ ... E	IP20	92782-01
215	401100102	4017807276138		1	E27	max. 60			A++ ... E	IP20	92782-02
215	401100114	4017807276145		1	E27	max. 60			A++ ... E	IP20	92782-14
154	401500307	4017807388879		3	E14	max. 9			A++ ... E	IP20	
560	402500378	4017807353822		3	GU10	max. 42			A++ ... E	IP20	
156	403100104	4017807353341		1	E14	max. 28			A++ ... E	IP20	92812-01
156	403100107	4017807353334		1	E14	max. 28			A++ ... E	IP20	92812-01
488	4035011-04	4017807090604		1	E27	max. 60			A++ ... E	IP20	92174
488	4035011-07	4017807090611		1	E27	max. 60			A++ ... E	IP20	92174
488	4035011-08	4017807090628		1	E27	max. 60			A++ ... E	IP20	92174
236	404200188	4017807354874		1	E27	max. 40			A++ ... E	IP20	
176	404600331	4017807377354		3	G9	max. 28			A++ ... E	IP20	
176	404600332	4017807377361		3	G9	max. 28			A++ ... E	IP20	
230	405000101	4017807369366		1	E27	max. 60			A++ ... E	IP20	
230	405000111	4017807369373		1	E27	max. 60			A++ ... E	IP20	
240	405000130	4017807353785		1	E14	max. 28			A++ ... E	IP20	
222	406500107	4017807280982		1	E27	max. 60			A++ ... E	IP20	
231	406600101	4017807334982		1	E27	max. 60			A++ ... E	IP20	
174	406700632	4017807364415		6	E27	max. 28			A++ ... E	IP20	
208	406800107	4017807387735		1	E27	max. 60			A++ ... E	IP20	
234	407000188	4017807356113		1	E27	max. 60			A++ ... E	IP20	
460	407300106	4017807285826		1	E27	max. 42			A++ ... E	IP20	
463	407400101	4017807285840		1	E27	max. 60			A++ ... E	IP20	92751S
457	407400179	4017807357882		1	E27	max. 60			A++ ... E	IP20	92822S
220	407500179	4017807382921		1	E27	max. 60			A++ ... E	IP20	
220	407500189	4017807382938		1	E27	max. 60			A++ ... E	IP20	
242	407700114	4017807298758		1	E14	max. 40			A++ ... E	IP20	
458	407800131	4017807299557		1	E27	max. 60			A++ ... E	IP20	92784-01
458	407800132	4017807303216		1	E27	max. 60			A++ ... E	IP20	92784-02
228	408200179	4017807392593		1	E27	max. 60			A++ ... E	IP20	
228	408200189	4017807392609		1	E27	max. 60			A++ ... E	IP20	
228	408290179	4017807392616		1	E27	max. 60			A++ ... E	IP20	
228	408290189	4017807392623		1	E27	max. 60			A++ ... E	IP20	
178	408800331	4017807390131		3	E14	max. 28			A++ ... E	IP20	
178	408800332	4017807390148		3	E14	max. 28			A++ ... E	IP20	

Seite Page	Artikel-Nr. Product No.	EAN-Nummer EAN-Number	incl. 	#	Sockel Fitting	Watt Watt	Lumen Lumen	Kelvin Kelvin	EEK (874/2012)	IP IP	Ersatzteile Spare parts
212	409100307	4017807389654		3	E27	max. 60			A++ ... E	IP20	
212	409100308	4017807389661		3	E27	max. 60			A++ ... E	IP20	
244	410900111	4017807354904		1	E27	max. 60			A++ ... E	IP20	
130	411210406	4017807367836	✓	4	G9	42	624	2800K	C	IP20	92829-40
128	411300606	4017807368055		6	G9	max. 33			A++ ... E	IP20	
462	416600200	4017807208498		2	E14	max. 40			A++ ... E	IP20	
465	4200011-06	4017807105650		1	E27	max. 75			A++ ... E	IP20	913240
489	420490107	4017807295337	✓	1	SMD-LED	6	560	3000K	A+	IP20	9243-01
489	420490132	4017807382525	✓	1	SMD-LED	6	560	3000K	A+	IP20	9243-01
483	420810107	4017807367614	✓	1	SMD-LED	12	1100	3000K	A+	IP20	
482	420910107	4017807367591	✓	1	SMD-LED	12	1100	3000K	A+	IP20	
482	420910108	4017807367607	✓	1	SMD-LED	12	1100	3000K	A+	IP20	
464	421100301	4017807194494		3	E27	max. 60			A++ ... E	IP20	92287S-01
464	421100302	4017807194500		3	E27	max. 60			A++ ... E	IP20	92287S-02
478	421910207	4017807267532	✓	4	SMD-LED	4,5	450	3000K	A+	IP20	92685
			✓	1	SMD-LED	4,5	450	3000K	A+		92685-01
478	421910228	4017807267549	✓	4	SMD-LED	4,5	450	3000K	A+	IP20	92685
			✓	1	SMD-LED	4,5	450	3000K	A+		92685-01
110	422410107	4017807358599	✓	1	SMD-LED	10	1000	3000K	A+	IP20	
110	422410108	4017807358605	✓	1	SMD-LED	10	1000	3000K	A+	IP20	
468	422510201	4017807286182	✓	1	SMD-LED	30	2100	3000K	A	IP20	92753
			✓	1	SMD-LED	5	400	3000K	A+		92753-01
473	422710307	4017807343076	✓	1	SMD-LED	34	3000	3000-6000K	A+	IP20	
			✓	1	SMD-LED	5,5	400	3000-6000K	A+		
473	422710308	4017807354270	✓	1	SMD-LED	34	3000	3000-6000K	A+	IP20	
			✓	1	SMD-LED	5,5	400	3000-6000K	A+		
446	422910207	4017807368017	✓	1	SMD-LED	36,4	3640	2700+	A+	IP20	92838
								3350+4000K			
			✓	1	SMD-LED	7,3	730	2700+	A+		
								3350+4000K			
446	422910208	4017807368024	✓	1	SMD-LED	36,4	3640	2700+	A+	IP20	92838
								3350+4000K			
			✓	1	SMD-LED	7,3	730	2700+	A+		
								3350+4000K			
449	422970206	4017807368260		1	E27	max. 60			A++ ... E	IP20	
			✓	1	SMD-LED	15,5	1370	3000K	A+		
88	423011807	4017807367683	✓	1	SMD-LED	18,9	1700	2700K	A+	IP20	
475	423510101	4017807345032	✓	1	SMD-LED	24	2000	RGBW	A	IP20	
480	423710107	4017807368284	✓	1	SMD-LED	8,8	950	3000K	A+	IP20	
480	423710108	4017807368291	✓	1	SMD-LED	8,8	950	3000K	A+	IP20	
470	423810107	4017807374582	✓	1	SMD-LED	6	600	3000+	A+	IP20	
								4200+6500K			
470	423810108	4017807374599	✓	1	SMD-LED	6	600	3000+	A+	IP20	
								4200+6500K			
470	423810207	4017807374568	✓	2	SMD-LED	6	600	3000+	A+	IP20	
								4200+6500K			
470	423810208	4017807374575	✓	2	SMD-LED	6	600	3000+	A+	IP20	
								4200+6500K			
470	423890207	4017807374544	✓	1	SMD-LED	43	4300	3000+	A+	IP20	
								4200+6500K			
			✓	1	SMD-LED	6	600	3000+	A+		
								4200+6500K			
470	423890208	4017807374551	✓	1	SMD-LED	43	4300	3000+	A+	IP20	
								4200+6500K			
			✓	1	SMD-LED	6	600	3000+	A+		
								4200+6500K			

Seite Page	Artikel-Nr. Product No.	EAN-Nummer EAN-Number	incl. 	#	Sockel Fitting	Watt Watt	Lumen Lumen	Kelvin Kelvin	EEK (874/2012)	IP IP	Ersatzteile Spare parts
486	424510187	4017807236705	✓	1	SMD-LED	5	480	3100K	A+	IP20	
487	424590107	4017807257021	✓	1	SMD-LED	5	480	3100K	A+	IP20	
556	424810107	4017807257687	✓	1	E14	4	320	3000K	A+	IP20	98249 98248
556	424810128	4017807257861	✓	1	E14	4	320	3000K	A+	IP20	98249 98248
556	424810207	4017807257700	✓	2	E14	4	320	3000K	A+	IP20	98249 98248
556	424810228	4017807257878	✓	2	E14	4	320	3000K	A+	IP20	98249 98248
474	424910207	4017807353938	✓	1	SMD-LED	20	2000	3000-6500K	A+	IP20	
			✓	1	SMD-LED	3,5	340	3000-6500K	A+		
102	425310107	4017807368376	✓	1	SMD-LED	6	550	3000K	A+	IP20	92828
104	425310207	4017807368383	✓	1	SMD-LED	34	3600	3000K	A+	IP20	92827-01
			✓	1	SMD-LED	6	550	3000K	A+		92827-02 92828-02 92818
106	425410607	4017807351347	✓	6	SMD-LED	4	360	3000K	A+	IP20	
106	425410608	4017807351354	✓	6	SMD-LED	4	360	3000K	A+	IP20	
100	425510107	4017807368000	✓	1	SMD-LED	6	630	3000K	A+	IP20	92833
478	426410207	4017807244717	✓	1	SMD-LED	20	1650	3000K	A	IP20	
			✓	1	SMD-LED	5	460	3000K	A+		
478	426410208	4017807244724	✓	1	SMD-LED	20	2000	3000K	A+	IP20	
			✓	1	SMD-LED	5	500	3000K	A+		
91	427113307	4017807368116	✓	1	SMD-LED	33	3000	3000K	A+	IP20	
466	427511801	4017807274332	✓	1	SMD-LED	18	1800	3000K	A+	IP20	
466	427511802	4017807274349	✓	1	SMD-LED	18	1800	3000K	A+	IP20	
466	427511887	4017807279511	✓	1	SMD-LED	18	1800	3000K	A+	IP20	
530	427890331	4017807383874	✓	3	SMD-LED	4,7	470	3000K	A+	IP20	
530	427890332	4017807383881	✓	3	SMD-LED	4,7	470	3000K	A+	IP20	
545	428210106	4017807256376	✓	1	SMD-LED	3,8	350	3100K	A+	IP20	
545	428210206	4017807256390	✓	2	SMD-LED	3,8	350	3100K	A+	IP20	
479	429110104	4017807267518	✓	1	SMD-LED	20	1750	3000K	A	IP20	92694
479	429110107	4017807267525	✓	1	SMD-LED	20	1750	3000K	A	IP20	92694
469	429910107	4017807273984	✓	4	SMD-LED	4,5	400	3000K	A+	IP20	
476	431912107	4017807211061	✓	1	R7S	230	4650	2800K	C	IP20	92383
			✓	1	G9	28	370	2800K	C		92383-01 92383-02
476	431912108	4017807211078	✓	1	R7S	230	4650	2800K	C	IP20	92383
			✓	1	G9	28	370	2800K	C		92383-01 92383-02
476	431912124	4017807211085	✓	1	R7S	230	4650	2800K	C	IP20	923831
			✓	1	G9	28	370	2800K	C		92383-0 92383-02
477	4344021-24	4017807053364	✓	1	R7S	230	4650	2800K	C	IP20	9356-24
			✓	1	G9	28	370	2800K	C		9214-24
477	438410207	4017807218114	✓	1	R7S	230	4650	2800K	C	IP20	92407
			✓	1	G9	28	370	2800K	C		92407-01
198	4470921-07	4017807213157	✓	2	G9	28	370	2800K	C	IP20	92379
198	4470921-24	4017807213164	✓	2	G9	28	370	2800K	C	IP20	92379
164	4601011-07	4017807057676		1	E27	max. 60			A++ ... E	IP20	9242
196	4602021-24	4017807196801		1	E27	max. 100			A++ ... E	IP20	92274
				1	E14	max. 40			A++ ... E		92274-01
217	461100101	4017807247220		1	E27	max. 60			A++ ... E	IP20	92597-01
217	461100102	4017807247237		1	E27	max. 60			A++ ... E	IP20	92597-02

Seite Page	Artikel-Nr. Product No.	EAN-Nummer EAN-Number	incl. 	#	Socket Fitting	Watt Watt	Lumen Lumen	Kelvin Kelvin	EEK (874/2012)	IP IP	Ersatzteile Spare parts
217	461100114	4017807247244		1	E27	max. 60			A++ ... E	IP20	92597-14
456	467400102	4017807358988		1	E27	max. 60			A++ ... E	IP20	92808
99	470090106	4017807369274	✓	1	SMD-LED	28	3000	3000+5000K	A+	IP20	
74	470110107	4017807343625	✓	1	SMD-LED	12	1050	3000K	A+	IP20	
68	470690307	4017807299700	✓	3	SMD-LED	4,5	430	3000K	A+	IP20	
82	470910406	4017807330632	✓	4	SMD-LED	4,2	450	3000K	A+	IP20	
202	471912401	4017807337204	✓	1	SMD-LED	24	2200	3000K	A+	IP20	
202	471912411	4017807337211	✓	1	SMD-LED	24	2200	3000K	A+	IP20	
114	472110307	4017807338386	✓	3	SMD-LED	4,3	400	3000K	A+	IP20	
72	472290105	4017807305753	✓	1	SMD-LED	20	1800	3000K	A	IP20	
484	472490201	4017807282566	✓	2	SMD-LED	4,3	430	3000K	A+	IP20	
484	472490207	4017807281415	✓	2	SMD-LED	4,5	430	3000K	A+	IP20	
58	472610531	4017807387643	✓	1	SMD-LED	44	3750	3000K	A	IP20	
92	472910106	4017807299281	✓	1	SMD-LED	20	1800	3000K	A+	IP20	
533	473190307	4017807302691	✓	3	SMD-LED	4,7	470	3000K	A+	IP20	
535	473190331	4017807302707	✓	3	SMD-LED	4,7	470	3000K	A+	IP20	
485	473190332	4017807382532	✓	3	SMD-LED	4,7	470	3000K	A+	IP20	
94	474112505	4017807281941	✓	1	SMD-LED	25	2300	3000K	A	IP20	
96	474310306	4017807281903	✓	3	SMD-LED	5	450	3000K	A+	IP20	
459	474410179	4017807359633	✓	1	SMD-LED	15	1450	3000K	A+	IP20	
108	474790107	4017807390087	✓	1	SMD-LED	8	750	3000K	A+	IP20	
108	474790132	4017807390094	✓	1	SMD-LED	8	750	3000K	A+	IP20	
112	475190131	4017807390292	✓	1	SMD-LED	8,5	830	3000K	A+	IP20	
452	475210279	4017807380477	✓	1	SMD-LED	13,5	1100	3000K	A	IP20	92847-79
				1	E27	max. 60			A++ ... E		
452	475210289	4017807380484	✓	1	SMD-LED	13,5	1100	3000K	A	IP20	92847-89
				1	E27	max. 60			A++ ... E		
454	475310307	4017807380439	✓	2	SMD-LED	7	600	3000K	A+	IP20	92844-07
				1	E27	max. 60			A++ ... E		
454	475310379	4017807380446	✓	2	SMD-LED	7	600	3000K	A+	IP20	92844-79
				1	E27	max. 60			A++ ... E		
118	476110106	4017807354003	✓	1	SMD-LED	30	2650	3000K	A+	IP20	
84	476310206	4017807298956	✓	2	SMD-LED	12	1200	3000K	A+	IP20	
120	478310206	4017807336795	✓	1	SMD-LED	22	2000	3000K	A	IP20	
			✓	1	SMD-LED	3,8	350	3000K	A+		
120	478310506	4017807336801	✓	5	SMD-LED	3,8	350	3000K	A+	IP20	
78	478490407	4017807281309	✓	4	SMD-LED	4,5	430	3000K	A+	IP20	
488	478610307	4017807287837	✓	3	SMD-LED	4,5	430	3000K	A+	IP20	92766
76	479190507	4017807373455	✓	5	SMD-LED	3,5	350 3000 + 5000K		A+	IP20	
76	479190579	4017807373462	✓	5	SMD-LED	3,5	350 3000 + 5000K		A+	IP20	
537	479310307	4017807336887	✓	3	SMD-LED	3,5	340	3000K	A++	IP20	
80	479890307	4017807372953	✓	3	SMD-LED	9	850 3000 + 5000K		A+	IP20	
60	479910105	4017807390117	✓	1	SMD-LED	26	2300	3000K	A+	IP20	
450	500200107	4017807368406		1	E27	max. 60			A++ ... E	IP20	92819
450	500200108	4017807378313		1	E27	max. 60			A++ ... E	IP20	
186	500500104	4017807268669		1	E14	max. 18			A++ ... E	IP20	
186	500500107	4017807268676		1	E14	max. 18			A++ ... E	IP20	
186	500500109	4017807268683		1	E14	max. 18			A++ ... E	IP20	
194	500700128	4017807354201		1	E14	max. 40			A++ ... E	IP20	92809
194	500700161	4017807354218		1	E14	max. 40			A++ ... E	IP20	92809-01
172	500800132	4017807388503		1	E14	max. 28			A++ ... E	IP20	
216	501100101	4017807246810		1	E14	max. 40			A++ ... E	IP20	
216	501100102	4017807246827		1	E14	max. 40			A++ ... E	IP20	
216	501100114	4017807246834		1	E14	max. 40			A++ ... E	IP20	
148	501600106	4017807390858		1	E27	max. 42			A++ ... E	IP20	

Seite Page	Artikel-Nr. Product No.	EAN-Nummer EAN-Number	incl. 	#	Sockel Fitting	Watt Watt	Lumen Lumen	Kelvin Kelvin	EEK (874/2012)	IP IP	Ersatzteile Spare parts
148	501600107	4017807390865		1	E27	max. 42			A++ ... E	IP20	
250	502700102	4017807286533		1	E14	max. 40			A++ ... E	IP20	92741
503	5027011-01	4017807017366		1	E27	max. 18			A++ ... E	IP20	
503	5027011-17	4017807051360		1	E27	max. 18			A++ ... E	IP20	
503	5027011-47	4017807124941		1	E27	max. 18			A++ ... E	IP20	
503	5028010-01	4017807051414		1	E14	max. 18			A++ ... E	IP20	
503	5028010-02	4017807051421		1	E14	max. 18			A++ ... E	IP20	
503	5028010-17	4017807051438		1	E14	max. 18			A++ ... E	IP20	
503	5028010-47	4017807051445		1	E14	max. 18			A++ ... E	IP20	
502	5029010-01	4017807051377		1	E27	max. 40			A++ ... E	IP20	
502	5029010-17	4017807051391		1	E27	max. 40			A++ ... E	IP20	
502	5029010-47	4017807051407		1	E27	max. 40			A++ ... E	IP20	
152	503000189	4017807347425		1	E14	max. 40			A++ ... E	IP20	92811-01
156	503100104	4017807353358		1	E14	max. 28			A++ ... E	IP20	92812-01
156	503100107	4017807353365		1	E14	max. 28			A++ ... E	IP20	92812-01
512	503200101	4017807372281		1	E14	max. 40			A++ ... E	IP20	
512	503200102	4017807372298		1	E14	max. 40			A++ ... E	IP20	
260	503300104	4017807286663		1	E14	max. 40			A++ ... E	IP20	
260	503300161	4017807286670		1	E14	max. 40			A++ ... E	IP20	
260	503300162	4017807286687		1	E14	max. 40			A++ ... E	IP20	
252	503500104	4017807286724		1	E14	max. 40			A++ ... E	IP20	92742
252	503500161	4017807286731		1	E14	max. 40			A++ ... E	IP20	92742
252	503500162	4017807286748		1	E14	max. 40			A++ ... E	IP20	92742
512	503600101	4017807372250		1	E14	max. 40			A++ ... E	IP20	
512	503600102	4017807372267		1	E14	max. 40			A++ ... E	IP20	
261	503700104	4017807286632		1	E14	max. 40			A++ ... E	IP20	
261	503700161	4017807286649		1	E14	max. 40			A++ ... E	IP20	
261	503700162	4017807286656		1	E14	max. 40			A++ ... E	IP20	
248	503800102	4017807286571		1	E14	max. 40			A++ ... E	IP20	92740
248	503800161	4017807286588		1	E14	max. 40			A++ ... E	IP20	92740
248	503800162	4017807286595		1	E14	max. 40			A++ ... E	IP20	92740
513	503900101	4017807372038		1	E14	max. 40			A++ ... E	IP20	
513	503900102	4017807372045		1	E14	max. 40			A++ ... E	IP20	
512	504000101	4017807372236		1	E14	max. 40			A++ ... E	IP20	
512	504000102	4017807372243		1	E14	max. 40			A++ ... E	IP20	
236	504200188	4017807354881		1	E27	max. 40			A++ ... E	IP20	
230	505000101	4017807369380		1	E27	max. 40			A++ ... E	IP20	
230	505000111	4017807369397		1	E27	max. 40			A++ ... E	IP20	
240	505000130	4017807353778		1	E14	max. 28			A++ ... E	IP20	
257	505100161	4017807330557		1	E27	max. 60			A++ ... E	IP20	
257	505100162	4017807330588		1	E27	max. 60			A++ ... E	IP20	
138	506100131	4017807355826		1	E14	max. 40			A++ ... E	IP20	92749-331
136	506100132	4017807355833		1	E14	max. 40			A++ ... E	IP20	92749-332
184	506100178	4017807355994		1	E14	max. 40			A++ ... E	IP20	
138	506190131	4017807355840		1	E27	max. 60			A++ ... E	IP20	92749-531
136	506190132	4017807355857		1	E27	max. 60			A++ ... E	IP20	92749-532
184	506190178	4017807356007		1	E27	max. 60			A++ ... E	IP20	
408	506400179	4017807286489		1	E14	max. 40			A++ ... E	IP20	
222	506500107	4017807280999		1	E14	max. 40			A++ ... E	IP20	
231	506600101	4017807335040		1	E14	max. 40			A++ ... E	IP20	
153	506700106	4017807356915		1	E14	max. 28			A++ ... E	IP20	
208	506800107	4017807387742		1	E27	max. 40			A++ ... E	IP20	
234	507000188	4017807356120		1	E27	max. 60			A++ ... E	IP20	
460	507300106	4017807285833		1	E14	max. 28			A++ ... E	IP20	
220	507500179	4017807382945		1	E14	max. 40			A++ ... E	IP20	

Seite Page	Artikel-Nr. Product No.	EAN-Nummer EAN-Number	incl. 	#	Sockel Fitting	Watt Watt	Lumen Lumen	Kelvin Kelvin	EEK (874/2012)	IP IP	Ersatzteile Spare parts
220	507500189	4017807382952		1	E14	max. 40			A++ ... E	IP20	
242	507700114	4017807298727		1	E14	max. 40			A++ ... E	IP20	
166	507800100	4017807189193		1	E14	max. 40			A++ ... E	IP20	92258-25
458	507800131	4017807329162		1	E14	max. 40			A++ ... E	IP20	
458	507800132	4017807329179		1	E14	max. 40			A++ ... E	IP20	
228	508200179	4017807392555		1	E27	max. 40			A++ ... E	IP20	
228	508200189	4017807392579		1	E27	max. 40			A++ ... E	IP20	
254	508400132	4017807387438		1	E14	max. 40			A++ ... E	IP20	
254	508400161	4017807387445		1	E14	max. 40			A++ ... E	IP20	
254	508400162	4017807387452		1	E14	max. 40			A++ ... E	IP20	
140	508800131	4017807394641		1	E14	max. 40			A++ ... E	IP20	92752-4031
140	508800132	4017807394658		1	E14	max. 40			A++ ... E	IP20	92752-4032
212	509100107	4017807398540		1	E27	max. 60			A++ ... E	IP20	
212	509100108	4017807398557		1	E27	max. 60			A++ ... E	IP20	
180	509300201	4017807356793		2	E14	max. 40			A++ ... E	IP20	
180	509300202	4017807356809		2	E14	max. 40			A++ ... E	IP20	
244	510900111	4017807354898		1	E14	max. 40			A++ ... E	IP20	
216	511100101	4017807246841		1	E27	max. 60			A++ ... E	IP20	92807-01
216	511100102	4017807246858		1	E27	max. 60			A++ ... E	IP20	92807-02
216	511100114	4017807246865		1	E27	max. 60			A++ ... E	IP20	92807-14
130	511210306	4017807367829		3	G9	max. 42			A++ ... E	IP20	92829-28
128	511300306	4017807368062		3	G9	max. 33			A++ ... E	IP20	
560	512500178	4017807353839		1	GU10	max. 42			A++ ... E	IP20	
142	515300106	4017807301236		1	E14	max. 40			A++ ... E	IP20	92736-01
62	520112061	4017807330762	✓	1	SMD-LED	12,5	1200	3000K	A+	IP20	
489	520490107	4017807295344	✓	1	SMD-LED	6	560	3000K	A+	IP20	9243-01
482	520910107	4017807367577	✓	1	SMD-LED	12	1100	3000K	A+	IP20	
482	520910108	4017807367584	✓	1	SMD-LED	12	1100	3000K	A+	IP20	
497	522520101	4017807226768	✓	1	SMD-LED	3,6	200	3000K	A	IP20	
497	522520102	4017807226775	✓	1	SMD-LED	3,6	200	3000K	A	IP20	
497	522520187	4017807226782	✓	1	SMD-LED	3,6	200	3000K	A	IP20	
449	522970206	4017807368277		1	E27	max. 40			A++ ... E	IP20	
			✓	1	SMD-LED	3,5	300	3000K	A+		
480	523710107	4017807368307	✓	1	SMD-LED	8,8	950	3000K	A+	IP20	
480	523710108	4017807368314	✓	1	SMD-LED	8,8	950	3000K	A+	IP20	
470	523810107	4017807374605	✓	1	SMD-LED	6	600	3000+	A+	IP20	
								4200+6500K			
470	523810108	4017807374612	✓	1	SMD-LED	6	600	3000+	A+	IP20	
								4200+6500K			
494	523910101	4017807226867	✓	1	SMD-LED	7	470	2500-4000K	A	IP20	
494	523910102	4017807226874	✓	1	SMD-LED	7	470	2500-4000K	A	IP20	
486	524510101	4017807233087	✓	1	SMD-LED	3	300	3100K	A+	IP20	
486	524510102	4017807229431	✓	1	SMD-LED	3	300	3100K	A+	IP20	
486	524510187	4017807229448	✓	1	SMD-LED	3	300	3100K	A+	IP20	
487	524590107	4017807257007	✓	1	SMD-LED	3	300	3100K	A+	IP20	
556	524810107	4017807257663	✓	1	E14	4	320	3000K	A+	IP20	98249 98248
556	524810128	4017807257885	✓	1	E14	4	320	3000K	A+	IP20	98249 98248
124	525112005	4017807292824	✓	1	SMD-LED	4	370	3000K	A+	IP20	
124	525113005	4017807296297	✓	1	SMD-LED	8	650	3000K	A	IP20	
504	525490106	4017807371710	✓	1	SMD-LED	4	350	3000K	A+	IP20	92826
504	525490107	4017807371727	✓	1	SMD-LED	4	350	3000K	A+	IP20	92826
504	525490179	4017807371734	✓	1	SMD-LED	4	350	3000K	A+	IP20	92826
100	525510107	4017807367997	✓	1	SMD-LED	6	630	3000K	A+	IP20	92833

Seite Page	Artikel-Nr. Product No.	EAN-Nummer EAN-Number	incl. 	#	Sockel Fitting	Watt Watt	Lumen Lumen	Kelvin Kelvin	EEK (874/2012)	IP IP	Ersatzteile Spare parts
495	525690101	4017807372342	✓	1	SMD-LED	9	1300	3000+ 4000+5000K	A++	IP20	
495	525690111	4017807372359	✓	1	SMD-LED	9	1300	3000+ 4000+5000K	A++	IP2	
504	525790107	4017807385663	✓	1	SMD-LED	4	350	3000K	A+	IP20	
504	525790108	4017807385670	✓	1	SMD-LED	4	350	3000K	A+	IP20	
504	525790132	4017807385687	✓	1	SMD-LED	4	350	3000K	A+	IP20	
494	526290187	4017807275995	✓	1	SMD-LED	5,5	500	3000 + 5000K	A+	IP20	
494	527090111	4017807372328	✓	1	SMD-LED	5	550	3000+ 4000+5000K	A+	IP20	
494	527090131	4017807372335	✓	1	SMD-LED	5	550	3000+ 4000+5000K	A+	IP20	
91	527111107	4017807368123	✓	1	SMD-LED	10	1000	3000K	A+	IP20	
498	527290101	4017807291438	✓	1	SMD-LED	5	550	3500K	A+	IP20	
498	527290102	4017807291445	✓	1	SMD-LED	5	550	3500K	A+	IP20	
492	527410101	4017807291452	✓	1	SMD-LED	6	670	3000K	A+	IP20	
492	527410142	4017807291513	✓	1	SMD-LED	6	670	3000K	A+	IP20	
505	527590107	4017807371758	✓	1	SMD-LED	4	350	3000K	A+	IP20	92825
505	527590179	4017807373103	✓	1	SMD-LED	4	350	3000K	A+	IP20	92825
491	527690131	4017807372304	✓	1	SMD-LED	5	550	3000+ 4000+5000K	A+	IP20	
491	527690132	4017807372311	✓	1	SMD-LED	5	550	3000+ 4000+5000K	A+	IP20	
501	527810101	4017807274356	✓	1	SMD-LED	4,4	450	3000K	A+	IP20	
501	527810106	4017807274363	✓	1	SMD-LED	4,4	450	3000K	A+	IP20	
501	527810107	4017807275025	✓	1	SMD-LED	4,4	450	3000K	A+	IP20	
501	527810115	4017807275018	✓	1	SMD-LED	4,4	450	3000K	A+	IP20	
501	527810119	4017807277012	✓	1	SMD-LED	4,4	450	3000K	A+	IP20	
493	527920101	4017807276046	✓	1	COB-LED	5	500	3000K	A+	IP20	
493	527920102	4017807276053	✓	1	COB-LED	5	500	3000K	A+	IP20	
545	528210106	4017807256413	✓	1	SMD-LED	3,8	350	3100K	A+	IP20	
500	528310107	4017807244564	✓	1	SMD-LED	3,8	350	3100K	A+	IP20	
500	528380107	4017807245899	✓	1	SMD-LED	3,8	350	3100K	A+	IP20	
506	529310107	4017807262018	✓	1	E14	4	320	3000K	A+	IP20	92672-07
506	529690100	4017807262032	✓	1	SMD-LED	4,5	400	3000K	A+	IP20	92671-00
506	529690107	4017807262070	✓	1	SMD-LED	4,5	400	3000K	A+	IP20	92671-07
507	529990103	4017807248340	✓	1	SMD-LED	4	350	3000K	A+	IP20	92584
507	529990106	4017807248357	✓	1	SMD-LED	4	350	3000K	A+	IP20	92584
507	529990107	4017807248364	✓	1	SMD-LED	4	350	3000K	A+	IP20	92584
507	529990124	4017807248371	✓	1	SMD-LED	4	350	3000K	A+	IP20	92584
52	551610107	4017807389821	✓	1	E27	11,5	806	RGBW	A	IP20	
222	556500107	4017807281002		1	E27	max. 60			A++ ... E	IP20	
164	5601011-07	4017807057683		1	E14	max. 40			A++ ... E	IP20	9355
196	5602021-24	4017807053494		2	E14	max. 40			A++ ... E	IP20	9292
99	570090106	4017807369281	✓	1	SMD-LED	9,5	800	3000+5000K	A+	IP20	
490	570190102	4017807298222	✓	1	SMD-LED	5	600	3000+ 4000+5000K	A+	IP20	
490	570190187	4017807298239	✓	1	SMD-LED	5	600	3000+ 4000+5000K	A+	IP20	
68	570610107	4017807299694	✓	1	SMD-LED	4,5	430	3000K	A+	IP20	
82	570990206	4017807330649	✓	2	SMD-LED	4,2	450	3000K	A+	IP20	
202	571911201	4017807337242	✓	1	SMD-LED	12	1100	3000K	A+	IP20	
202	571911211	4017807337259	✓	1	SMD-LED	12	1100	3000K	A+	IP20	
114	572110207	4017807338379	✓	2	SMD-LED	4,3	400	3000K	A+	IP20	
110	572410107	4017807337006	✓	1	SMD-LED	6	560	3000K	A+	IP20	





Seite Page	Artikel-Nr. Product No.	EAN-Nummer EAN-Number	incl. 	#	Sockel Fitting	Watt Watt	Lumen Lumen	Kelvin Kelvin	EEK (874/2012)	IP IP	Ersatzteile Spare parts
110	572410108	4017807345162	✓	1	SMD-LED	6	560	3000K	A+	IP20	
549	572810101	4017807262322	✓	1	SMD-LED	3,8	350	3100K	A+	IP20	
547	572810106	4017807262339	✓	1	SMD-LED	3,8	350	3100K	A+	IP20	
92	572910106	4017807303162	✓	1	SMD-LED	14,5	1300	3000K	A+	IP20	
533	573190107	4017807302677	✓	1	SMD-LED	4,7	470	3000K	A+	IP20	
534	573190131	4017807302684	✓	1	SMD-LED	4,7	470	3000K	A+	IP20	
500	573910101	4017807275636	✓	1	SMD-LED	4,8	450	3000K	A+	IP20	92839
500	573910102	4017807275643	✓	1	SMD-LED	4,8	450	3000K	A+	IP20	92839
500	573910106	4017807275650	✓	1	SMD-LED	4,8	450	3000K	A+	IP20	92839
510	574090107	4017807268973	✓	1	E14	4	320	3000K	A+	IP20	92679-01
94	574191005	4017807281958	✓	1	SMD-LED	10	900	3000K	A	IP20	
459	574410179	4017807359626	✓	1	SMD-LED	6,5	660	3000K	A+	IP20	
108	574790107	4017807390063	✓	1	SMD-LED	8	750	3000K	A+	IP20	
108	574790132	4017807390070	✓	1	SMD-LED	8	750	3000K	A+	IP20	
112	575190131	4017807390315	✓	1	SMD-LED	8,5	830	3000K	A+	IP20	
452	575210279	4017807380491	✓	1	SMD-LED	5	450	3000K	A+	IP20	
				1	E27	max. 40			A++ ... E		
452	575210289	4017807380507	✓	1	SMD-LED	5	450	3000K	A+	IP20	
				1	E27	max. 40			A++ ... E		
454	575310307	4017807380453	✓	2	SMD-LED	3	300	3000K	A+	IP20	
				1	E27	max. 40			A++ ... E		
454	575310379	4017807380460	✓	2	SMD-LED	3	300	3000K	A+	IP20	
				1	E27	max. 40			A++ ... E		
84	576390206	4017807298949	✓	2	SMD-LED	8	800	3000K	A+	IP20	
98	576410806	4017807287257	✓	1	SMD-LED	6	600	3000K	A+	IP20	
98	576491806	4017807281613	✓	1	SMD-LED	18	1600	3000K	A	IP20	
496	577390101	4017807279559	✓	1	SMD-LED	4	360	3000K	A+	IP20	
			✓	1	SMD-LED	4	400	5000K	A+		
496	577390187	4017807280357	✓	1	SMD-LED	4	360	3000K	A+	IP20	
			✓	1	SMD-LED	4	400	5000K	A+		
200	578090107	4017807391190	✓	1	SMD-LED	7,5	750	3000K	A+	IP20	
200	578090108	4017807391206	✓	1	SMD-LED	7,5	750	3000K	A+	IP20	
122	578310106	4017807336818	✓	1	SMD-LED	3,8	350	3000K	A+	IP20	
76	579190207	4017807373493	✓	2	SMD-LED	3,5	350 3000 + 5000K		A+	IP20	
76	579190279	4017807373509	✓	2	SMD-LED	3,5	350 3000 + 5000K		A+	IP20	
537	579310207	4017807336870	✓	2	SMD-LED	3,5	340	3000K	A++	IP20	
374	579790104	4017807275285	✓	1	SMD-LED	4	380	3000K	A++	IP20	
374	579790107	4017807275322	✓	1	SMD-LED	4	380	3000K	A++	IP20	
374	579790108	4017807275339	✓	1	SMD-LED	4	380	3000K	A++	IP20	
80	579890307	4017807372960	✓	3	SMD-LED	4,5	300 3000 + 5000K		A+	IP20	
60	579910105	4017807390124	✓	1	SMD-LED	9	800	3000K	A+	IP20	
510	5900011-04	4017807108026		1	E14	max. 40			A++ ... E	IP20	9424
510	5900011-07	4017807108033		1	E14	max. 40			A++ ... E	IP20	9424
510	5901011-07	4017807108057		1	E14	max. 40			A++ ... E	IP21	9426
510	5908011-07	4017807135749		1	E14	max. 40			A++ ... E	IP20	9262-01
515	5914011-01	4017807150445		1	E14	max. 60			A++ ... E	IP20	92281-01
515	5914011-02	4017807150452		1	E14	max. 60			A++ ... E	IP20	92281
515	5914011-10	4017807150469		1	E14	max. 60			A++ ... E	IP20	92281-10
515	5914011-42	4017807150476		1	E14	max. 60			A++ ... E	IP20	92281-42
506	592000107	4017807166705		1	G9	max. 40			A++ ... E	IP20	9704
509	5922011-07	4017807081770		1	E27	max. 60			A++ ... E	IP20	9309
508	5925011-07	4017807094985		1	E14	max. 60			A++ ... E	IP20	9321
508	5925011-08	4017807094992		1	E14	max. 60			A++ ... E	IP20	9321
508	5930011-01	4017807112788		1	E14	max. 40			A++ ... E	IP20	9395
508	5930011-24	4017807112801		1	E14	max. 40			A++ ... E	IP20	9396

Seite Page	Artikel-Nr. Product No.	EAN-Nummer EAN-Number	incl. 	#	Sockel Fitting	Watt Watt	Lumen Lumen	Kelvin Kelvin	EEK (874/2012)	IP IP	Ersatzteile Spare parts
511	593900100	4017807224603		1	E14	max. 40			A++ ... E	IP20	92496
511	593900142	4017807224634		1	E14	max. 40			A++ ... E	IP20	92496-42
511	593900192	4017807224641		1	E14	max. 40			A++ ... E	IP20	92496-92
226	595400101	4017807337778		1	E14	max. 25			A++ ... E	IP20	
226	595400111	4017807337785		1	E14	max. 25			A++ ... E	IP20	
224	595400141	4017807391046		1	E14	max. 25			A++ ... E	IP20	
226	595400179	4017807337792		1	E14	max. 25			A++ ... E	IP20	
226	595400189	4017807337808		1	E14	max. 25			A++ ... E	IP20	
511	595500106	4017807154528		1	E14	max. 40			A++ ... E	IP20	9610-01
511	595500107	4017807154535		1	E14	max. 40			A++ ... E	IP20	9610-00
511	595500108	4017807156454		1	E14	max. 60			A++ ... E	IP20	9610-00
511	595500124	4017807154559		1	E14	max. 40			A++ ... E	IP20	9610-00
515	5960011-01	4017807149609		1	E14	max. 40			A++ ... E	IP20	92282
515	5960011-02	4017807149623		1	E14	max. 40			A++ ... E	IP20	
165	598400106	4017807240214		1	E14	max. 40			A++ ... E	IP20	
509	599000106	4017807195958		1	E14	max. 40			A++ ... E	IP20	92271-06
509	599000107	4017807195965		1	E14	max. 40			A++ ... E	IP20	92271-07
509	599000108	4017807195972		1	E14	max. 40			A++ ... E	IP20	92271-07
509	599000118	4017807195989		1	E14	max. 40			A++ ... E	IP20	92271-18
509	599000124	4017807195996		1	E14	max. 40			A++ ... E	IP20	92271-07
514	599600101	4017807256055		1	E14	max. 40			A++ ... E	IP20	
514	599600102	4017807257472		1	E14	max. 40			A++ ... E	IP20	
514	599600115	4017807256086		1	E14	max. 40			A++ ... E	IP20	
514	599600119	4017807257793		1	E14	max. 40			A++ ... E	IP20	
514	599600142	4017807256093		1	E14	max. 40			A++ ... E	IP20	
194	600700328	4017807354225		3	E14	max. 40			A++ ... E	IP20	92809
194	600700361	4017807354232		3	E14	max. 40			A++ ... E	IP20	92809-01
170	600800532	4017807388527		5	E14	max. 28			A++ ... E	IP20	
330	601100200	4017807218411		2	E14	max. 40			A++ ... E	IP20	92415 92415-01
334	601400100	4017807195484		1	E27	max. 40			A++ ... E	IP20	92287-00
334	601400101	4017807195491		1	E27	max. 40			A++ ... E	IP20	92287-01
334	601400106	4017807224580		1	E27	max. 40			A++ ... E	IP20	92460
154	601500507	4017807388862		5	E14	max. 28			A++ ... E	IP20	
333	601900100	4017807223545		1	E27	max. 40			A++ ... E	IP20	92464
333	601900200	4017807223552		2	E27	max. 40			A++ ... E	IP20	92464-02
334	602100100	4017807223569		1	E27	max. 40			A++ ... E	IP20	92465
334	602100200	4017807223576		2	E27	max. 40			A++ ... E	IP20	92465-02
331	602400106	4017807244915		1	E27	max. 40			A++ ... E	IP20	92579-25
331	602400206	4017807244922		2	E27	max. 40			A++ ... E	IP20	92579-30
331	602400306	4017807385076		3	E27	max. 40			A++ ... E	IP20	
162	602500101	4017807364941		1	E27	max. 40			A++ ... E	IP20	92831-30
162	602500201	4017807364958		2	E27	max. 40			A++ ... E	IP20	92831-40
162	602500301	4017807364965		3	E27	max. 40			A++ ... E	IP20	92831-50
333	602600200	4017807224528		2	E14	max. 40			A++ ... E	IP20	92456
333	602700200	4017807224535		2	E27	max. 60			A++ ... E	IP20	92457
352	603800201	4017807293845		2	E14	max. 60			A++ ... E	IP20	
352	603800214	4017807294071		2	E14	max. 60			A++ ... E	IP20	
352	603800287	4017807294088		2	E14	max. 60			A++ ... E	IP20	
352	603800401	4017807294095		4	E27	max. 60			A++ ... E	IP20	
352	603800414	4017807294101		4	E27	max. 60			A++ ... E	IP20	
352	603800487	4017807294118		4	E27	max. 60			A++ ... E	IP20	
216	603900201	4017807289688		2	E14	max. 40			A++ ... E	IP20	92631-30
216	603900202	4017807289695		2	E14	max. 40			A++ ... E	IP20	92631-30
216	603900214	4017807289701		2	E14	max. 40			A++ ... E	IP20	92631-30

Seite Page	Artikel-Nr. Product No.	EAN-Nummer EAN-Number	incl. 	#	Sockel Fitting	Watt Watt	Lumen Lumen	Kelvin Kelvin	EEK (874/2012)	IP IP	Ersatzteile Spare parts
216	603900301	4017807256536		3	E27	max. 60			A++ ... E	IP20	92662
216	603900302	4017807256543		3	E27	max. 60			A++ ... E	IP20	92662-02
216	603900314	4017807256550		3	E27	max. 60			A++ ... E	IP20	92662-14
216	603900501	4017807369298		5	E27	max. 60			A++ ... E	IP20	
216	603900502	4017807369304		5	E27	max. 60			A++ ... E	IP20	
216	603900514	4017807369311		5	E27	max. 60			A++ ... E	IP20	
332	604000106	4017807295689		1	E27	max. 40			A++ ... E	IP20	92769-25
332	604000206	4017807295696		2	E27	max. 40			A++ ... E	IP20	92769-30
330	604200106	4017807293852		1	E27	max. 40			A++ ... E	IP20	92776
330	604200206	4017807293869		2	E27	max. 40			A++ ... E	IP20	92776-01
350	604300301	4017807372014		3	E27	max. 40			A++ ... E	IP20	
350	604300302	4017807372021		3	E27	max. 40			A++ ... E	IP20	
163	604400101	4017807364996		1	E27	max. 40			A++ ... E	IP20	92830-30
163	604400201	4017807365009		2	E27	max. 40			A++ ... E	IP20	92830-40
163	604400301	4017807365016		3	E27	max. 40			A++ ... E	IP20	92830-50
176	604600531	4017807374827		5	G9	max. 28			A++ ... E	IP20	
176	604600532	4017807374834		5	G9	max. 28			A++ ... E	IP20	
226	605400501	4017807349214		5	E14	max. 25			A++ ... E	IP20	
226	605400511	4017807349221		5	E14	max. 25			A++ ... E	IP20	
224	605400541	4017807391039		5	E14	max. 25			A++ ... E	IP20	
226	605400579	4017807349238		5	E14	max. 25			A++ ... E	IP20	
226	605400589	4017807349245		5	E14	max. 25			A++ ... E	IP20	
336	605600307	4017807236996		3	E14	max. 40			A++ ... E	IP20	92529
336	605600507	4017807237009		5	E14	max. 40			A++ ... E	IP20	92529
126	605800406	4017807377453		4	G9	max. 28			A++ ... E	IP20	
188	606000307	4017807374674		3	E27	max. 42			A++ ... E	IP20	
188	606000331	4017807374650		3	E27	max. 42			A++ ... E	IP20	
188	606000332	4017807374667		3	E27	max. 42			A++ ... E	IP20	
138	606100231	4017807394504		2	E27	max. 40			A++ ... E	IP20	92755-431
136	606100232	4017807394511		2	E27	max. 40			A++ ... E	IP20	92755-432
138	606100331	4017807394528		3	E27	max. 40			A++ ... E	IP20	92755-531
136	606100332	4017807394535		3	E27	max. 40			A++ ... E	IP20	92755-532
364	606600178	4017807364354		1	GU10	max. 35			A++ ... E	IP20	
174	606700632	4017807373448		6	E27	max. 40			A++ ... E	IP20	
210	606800307	4017807387841		3	E27	max. 60			A++ ... E	IP20	
256	606900161	4017807351781		1	E27	max. 60			A++ ... E	IP20	
256	606900162	4017807356823		1	E27	max. 60			A++ ... E	IP20	
160	607700100	4017807385311		1	E27	max. 40			A++ ... E	IP20	
160	607700200	4017807385328		2	E27	max. 40			A++ ... E	IP20	
160	607700300	4017807385335		3	E27	max. 40			A++ ... E	IP20	
166	607800100	4017807189216		1	E27	max. 60			A++ ... E	IP20	92259-30
351	608100224	4017807211795		2	E27	max. 42			A++ ... E	IP20	92472-01
351	608100324	4017807211788		3	E27	max. 60			A++ ... E	IP20	92472
228	608200279	4017807392531		2	E14	max. 40			A++ ... E	IP20	
228	608200289	4017807392548		2	E14	max. 40			A++ ... E	IP20	
158	608700179	4017807385427		1	E27	max. 40			A++ ... E	IP20	
158	608700189	4017807385434		1	E27	max. 40			A++ ... E	IP20	
158	608700279	4017807385441		2	E27	max. 40			A++ ... E	IP20	
158	608700289	4017807385458		2	E27	max. 40			A++ ... E	IP20	
158	608700379	4017807385465		3	E27	max. 40			A++ ... E	IP20	
158	608700389	4017807385472		3	E27	max. 40			A++ ... E	IP20	
178	608800631	4017807387872		6	E14	max. 40			A++ ... E	IP20	
178	608800632	4017807387889		6	E14	max. 40			A++ ... E	IP20	
337	609000306	4017807174021		3	E14	max. 40			A++ ... E	IP20	
432	609700306	4017807196481		3	E14	max. 40			A++ ... E	IP20	

Seite Page	Artikel-Nr. Product No.	EAN-Nummer EAN-Number	incl. 	#	Socket Fitting	Watt Watt	Lumen Lumen	Kelvin Kelvin	EEK (874/2012)	IP IP	Ersatzteile Spare parts
182	609800431	4017807387704		4	E27	max. 40			A++ ... E	IP20	
182	609800432	4017807387711		4	E27	max. 40			A++ ... E	IP20	
168	609900331	4017807330960		3	E14	max. 40			A++ ... E	IP20	
168	609900332	4017807330984		3	E14	max. 40			A++ ... E	IP20	
335	6101011-01	4017807017557		1	E27	max. 60			A++ ... E	IP20	9218-01
335	6101011-06	4017807028386		1	E27	max. 60			A++ ... E	IP20	9218-01
335	6101011-07	4017807028393		1	E27	max. 60			A++ ... E	IP20	9218-01
196	6102021-24	4017807053296		2	E27	max. 60			A++ ... E	IP20	92126
190	610300406	4017807369168		4	E14	max. 28			A++ ... E	IP20	
190	610300428	4017807369175		4	E14	max. 28			A++ ... E	IP20	
328	6105011-01	4017807053968		1	E27	max. 40			A++ ... E	IP20	9285-01
328	6105021-01	4017807098440		2	E27	max. 40			A++ ... E	IP20	9287-01
329	6107011-07	4017807028041		1	E27	max. 60			A++ ... E	IP20	9231
329	6107021-07	4017807080704		2	E27	max. 60			A++ ... E	IP20	92151
130	611210506	4017807367782		5	G9	max. 42			A++ ... E	IP20	92829-40
128	611300506	4017807368079		5	G9	max. 33			A++ ... E	IP20	
335	6160011-00	4017807131895		1	E27	max. 60			A++ ... E	IP20	9516
334	6196011-01	4017807138238		1	E27	max. 40			A++ ... E	IP20	9523-01
334	6196011-07	4017807138245		1	E27	max. 40			A++ ... E	IP20	9523-07
297	620210206	4017807392449	✓	1	SMD-LED	30	2500	3000K	A+	IP20	
			✓	1	SMD-LED	15	1300	RGBW	A+		
523	621410505	4017807220940	✓	5	SMD-LED	4,5	400	3000K	A+	IP20	92426
313	621512406	4017807293944	✓	1	SMD-LED	10	900	3000K	A+	IP20	
			✓	5	SMD-LED	2,8	340	3000K	A++		
313	621513506	4017807293951	✓	1	SMD-LED	12,5	1250	3000K	A	IP20	
			✓	5	SMD-LED	4,5	450	3000K	A+		
204	621911201	4017807337105	✓	1	SMD-LED	11	1100	3000K	A+	IP20	
204	621911211	4017807337112	✓	1	SMD-LED	11	1100	3000K	A+	IP20	
206	621911279	4017807337129	✓	1	SMD-LED	11	1100	3000K	A+	IP20	
206	621911289	4017807337136	✓	1	SMD-LED	11	1100	3000K	A+	IP20	
204	621912401	4017807337143	✓	1	SMD-LED	22	2200	3000K	A+	IP20	
204	621912411	4017807337150	✓	1	SMD-LED	22	2200	3000K	A+	IP20	
206	621912479	4017807337167	✓	1	SMD-LED	22	2200	3000K	A+	IP20	
206	621912489	4017807337174	✓	1	SMD-LED	22	2200	3000K	A+	IP20	
204	621914001	4017807384468	✓	1	SMD-LED	40	3300	3000 - 6500K	A	IP20	
204	621914011	4017807384475	✓	1	SMD-LED	40	3300	3000 - 6500K	A	IP20	
204	621915501	4017807384482	✓	1	SMD-LED	60	5000	3000 - 6500K	A	IP20	
204	621915511	4017807384499	✓	1	SMD-LED	60	5000	3000 - 6500K	A	IP20	
269	622713007	4017807226812	✓	1	SMD-LED	12	1100	3500K	A+	IP44	
269	622714007	4017807226805	✓	1	SMD-LED	18	1600	3500K	A+	IP44	
338	622811527	4017807262391	✓	15	SMD-LED	1	90	3000K	A++	IP20	92686
338	622811528	4017807262407	✓	15	SMD-LED	1,1	115	3000K	A++	IP20	92686
88	623012407	4017807367669	✓	1	SMD-LED	24,3	2200	3000K	A+	IP20	
322	624011206	4017807245141	✓	1	SMD-LED	12	1050	3000K	A+	IP20	
322	624012306	4017807245905	✓	1	SMD-LED	25	2000	3000K	A	IP20	
344	624110209	4017807337020	✓	1	SMD-LED	12	1100	3000K	A+	IP20	92795
			✓	1	SMD-LED	3,5	350	3000K	A+		
344	624110279	4017807337051	✓	1	SMD-LED	12	1100	3000K	A+	IP20	92795
			✓	1	SMD-LED	3,5	350	3000K	A+		
344	624110289	4017807337068	✓	1	SMD-LED	12	1100	3000K	A+	IP20	92795
			✓	1	SMD-LED	3,5	350	3000K	A+		
345	624210209	4017807337075	✓	1	SMD-LED	12	1100	3000K	A+	IP20	92796
			✓	1	SMD-LED	3,5	350	3000K	A+		
345	624210279	4017807337082	✓	1	SMD-LED	12	1100	3000K	A+	IP20	92796
			✓	1	SMD-LED	3,5	350	3000K	A+		

Seite Page	Artikel-Nr. Product No.	EAN-Nummer EAN-Number	incl. 	#	Sockel Fitting	Watt Watt	Lumen Lumen	Kelvin Kelvin	EEK (874/2012)	IP IP	Ersatzteile Spare parts
345	624210289	4017807337099	✓	1	SMD-LED	12	1100	3000K	A+	IP20	92796
			✓	1	SMD-LED	3,5	350	3000K	A+		
296	624410306	4017807353952	✓	3	SMD-LED	4,2	400	RGBW	A+	IP20	
296	624410506	4017807353969	✓	5	SMD-LED	4,2	400	RGBW	A+	IP20	
296	624410606	4017807353976	✓	6	SMD-LED	4,2	400	RGBW	A+	IP20	
556	624830307	4017807257724	✓	3	E14	4	320	3000K	A+	IP20	98249 98248
556	624830328	4017807257892	✓	3	E14	4	320	3000K	A+	IP20	98249 98248
322	625211007	4017807229318	✓	3	SMD-LED	4,5	400	3000K	A+	IP20	92508
268	625911205	4017807245165	✓	1	SMD-LED	12	1050	3000K	A+	IP20	
268	625912305	4017807245912	✓	1	SMD-LED	23	2000	3000K	A	IP20	
327	626510901	4017807245196	✓	1	SMD-LED	9	750	3000K	A+	IP20	
327	626510987	4017807245202	✓	1	SMD-LED	9	750	3000K	A+	IP20	
327	626511201	4017807245219	✓	1	SMD-LED	12	1050	3000K	A+	IP20	
327	626511287	4017807245226	✓	1	SMD-LED	12	1050	3000K	A+	IP20	
327	626512501	4017807246797	✓	1	SMD-LED	25	2000	3000K	A	IP20	
327	626512587	4017807246803	✓	1	SMD-LED	25	2000	3000K	A	IP20	
326	627111001	4017807267389	✓	1	SMD-LED	10	730	3000K	A	IP20	
326	627111501	4017807267402	✓	1	SMD-LED	15	1100	3000K	A	IP20	
90	627113407	4017807368130	✓	1	SMD-LED	30	3200	3000K	A+	IP20	
90	627114807	4017807368147	✓	1	SMD-LED	40	4300	3000K	A+	IP20	
314	627910406	4017807261691	✓	4	SMD-LED	4,3	430	3000K	A+	IP20	92689-26
314	627910506	4017807263961	✓	5	SMD-LED	4,5	400	3000K	A+	IP20	92689-38
544	628290506	4017807259834	✓	5	SMD-LED	3,8	350	3100K	A+	IP20	
292	628313001	4017807348002	✓	1	SMD-LED	30	2500	3000-5500K	A	IP20	
289	628513001	4017807298819	✓	1	SMD-LED	30	2400	3000-5500K	A	IP20	
315	628611806	4017807245844	✓	1	SMD-LED	18	1400	3000K	A	IP20	92572-38 92572-26
289	628613001	4017807298826	✓	1	SMD-LED	30	2400	3000-5500K	A	IP20	
288	628815001	4017807279696	✓	1	SMD-LED	45	4000	3000-5500K	A+	IP20	
287	628818000	4017807357868	✓	1	SMD-LED	60	5800	3000-5500K	A+	IP20	
280	628890100	4017807381542	✓	1	SMD-LED	45	4000	3000-5500K	A+	IP20	
286	628898000	4017807357875	✓	1	SMD-LED	60	5800	3000-5500K	A+	IP20	
288	628915001	4017807272307	✓	1	SMD-LED	45	4000	3000-5500K	A+	IP20	
281	628918000	4017807381498	✓	1	SMD-LED	70	6500	3000-5500K	A+	IP20	
280	628990100	4017807381535	✓	1	SMD-LED	45	4000	3000-5500K	A+	IP20	
278	629010101	4017807381511	✓	1	SMD-LED	45	4000	3000-5500K	A+	IP20	
278	629090101	4017807381528	✓	1	SMD-LED	70	6500	3000-5500K	A+	IP20	
324	629110106	4017807325249	✓	1	SMD-LED	9	810	3000K	A+	IP20	92783
598	629510101	4017807256819	✓	1	SMD-LED	4,3	345	3000K	A+	IP65	
598	629510105	4017807256826	✓	1	SMD-LED	5,5	380	3000K	A+	IP65	
575	650000106	4017807376210		1	GU10	max. 15			A++ ... E	IP20	
575	650000107	4017807376234		1	GU10	max. 15			A++ ... E	IP20	
575	650000108	4017807376241		1	GU10	max. 15			A++ ... E	IP20	
575	650000131	4017807376203		1	GU10	max. 15			A++ ... E	IP20	
575	650000132	4017807378061		1	GU10	max. 15			A++ ... E	IP20	
574	650000306	4017807376258		3	GU10	max. 15			A++ ... E	IP20	
574	650000307	4017807376265		3	GU10	max. 15			A++ ... E	IP20	
574	650000331	4017807376272		3	GU10	max. 15			A++ ... E	IP20	
575	650100106	4017807376302		1	GU10	max. 15			A++ ... E	IP20	
575	650100107	4017807376319		1	GU10	max. 15			A++ ... E	IP20	
575	650100108	4017807376326		1	GU10	max. 15			A++ ... E	IP20	
575	650100131	4017807376296		1	GU10	max. 15			A++ ... E	IP20	
575	650100132	4017807378078		1	GU10	max. 15			A++ ... E	IP20	

Seite Page	Artikel-Nr. Product No.	EAN-Nummer EAN-Number	incl. 	#	Sockel Fitting	Watt Watt	Lumen Lumen	Kelvin Kelvin	EEK (874/2012)	IP IP	Ersatzteile Spare parts
574	650100306	4017807376333		3	GU10	max. 15			A++ ... E	IP20	
574	650100307	4017807376340		3	GU10	max. 15			A++ ... E	IP20	
574	650100331	4017807376357		3	GU10	max. 15			A++ ... E	IP20	
577	650210106	4017807376388	✓	1	SMD-LED	5	370	3000K	A+	IP20	
577	650210107	4017807376395	✓	1	SMD-LED	5	370	3000K	A+	IP20	
577	650210131	4017807376371	✓	1	SMD-LED	5	370	3000K	A+	IP20	
576	650210306	4017807376418	✓	3	SMD-LED	5	370	3000K	A+	IP20	
576	650210307	4017807376425	✓	3	SMD-LED	5	370	3000K	A+	IP20	
576	650210331	4017807376432	✓	3	SMD-LED	5	370	3000K	A+	IP20	
577	650310106	4017807376463	✓	1	SMD-LED	5	370	3000K	A+	IP20	
577	650310107	4017807376470	✓	1	SMD-LED	5	370	3000K	A+	IP20	
577	650310131	4017807376456	✓	1	SMD-LED	5	370	3000K	A+	IP20	
576	650310306	4017807376494	✓	3	SMD-LED	5	370	3000K	A+	IP20	
576	650310307	4017807376500	✓	3	SMD-LED	5	370	3000K	A+	IP20	
576	650310331	4017807376517	✓	3	SMD-LED	5	370	3000K	A+	IP20	
579	650410106	4017807376630	✓	1	SMD-LED	5,5	345	3000K	A	IP23	
579	650410107	4017807376647	✓	1	SMD-LED	5,5	345	3000K	A	IP23	
579	650410131	4017807376623	✓	1	SMD-LED	5,5	345	3000K	A	IP23	
579	650410132	4017807378030	✓	1	SMD-LED	5,5	345	3000K	A	IP23	
578	650410306	4017807376661	✓	3	SMD-LED	5,5	345	3000K	A	IP23	
578	650410307	4017807376678	✓	3	SMD-LED	5,5	345	3000K	A	IP23	
578	650410331	4017807376685	✓	3	SMD-LED	5,5	345	3000K	A	IP23	
579	650510106	4017807376753	✓	1	SMD-LED	5,5	345	3000K	A	IP23	
579	650510107	4017807376760	✓	1	SMD-LED	5,5	345	3000K	A	IP23	
579	650510131	4017807376722	✓	1	SMD-LED	5,5	345	3000K	A	IP23	
579	650510132	4017807378085	✓	1	SMD-LED	5,5	345	3000K	A	IP23	
578	650510306	4017807376838	✓	3	SMD-LED	5,5	345	3000K	A	IP23	
578	650510307	4017807376845	✓	3	SMD-LED	5,5	345	3000K	A	IP23	
578	650510331	4017807376852	✓	3	SMD-LED	5,5	345	3000K	A	IP23	
581	650610106	4017807376869	✓	1	SMD-LED	5,5	345	3000K	A	IP65	
581	650610107	4017807376876	✓	1	SMD-LED	5,5	345	3000K	A	IP65	
581	650610131	4017807376890	✓	1	SMD-LED	5,5	345	3000K	A	IP65	
580	650610306	4017807376906	✓	3	SMD-LED	5,5	345	3000K	A	IP65	
580	650610307	4017807376913	✓	3	SMD-LED	5,5	345	3000K	A	IP65	
580	650610331	4017807376920	✓	3	SMD-LED	5,5	345	3000K	A	IP65	
581	650710106	4017807376937	✓	1	SMD-LED	5,5	345	3000K	A	IP65	
581	650710107	4017807376944	✓	1	SMD-LED	5,5	345	3000K	A	IP65	
581	650710131	4017807376951	✓	1	SMD-LED	5,5	345	3000K	A	IP20	
580	650710306	4017807376975	✓	3	SMD-LED	5,5	345	3000K	A	IP65	
580	650710307	4017807376968	✓	3	SMD-LED	5,5	345	3000K	A	IP65	
580	650710331	4017807376982	✓	3	SMD-LED	5,5	345	3000K	A	IP65	
583	650910106	4017807376999	✓	1	SMD-LED	18	1500	3000K	A+	IP44	
583	650910107	4017807377002	✓	1	SMD-LED	18	1500	3000K	A+	IP44	
583	650910131	4017807377019	✓	1	SMD-LED	18	1500	3000K	A+	IP44	
43	651210507	4017807389753	✓	1	SMD-LED	23	2200	RGBW	A+	IP20	
46	651914001	4017807389609	✓	1	SMD-LED	36	3400	RGBW	A+	IP20	
46	651915501	4017807389616	✓	1	SMD-LED	45	4200	RGBW	A+	IP20	
349	655212031	4017807355758	✓	1	SMD-LED	20	1720	3000K	A	IP20	92748-20
349	655213031	4017807355765	✓	1	SMD-LED	30	2580	3000K	A	IP20	92748-30
44	656010100	4017807389845	✓	1	SMD-LED	27	2550	RGBW	A+	IP20	
44	656010101	4017807389838	✓	1	SMD-LED	27	2550	RGBW	A+	IP20	
42	656090100	4017807389869	✓	1	SMD-LED	40	3700	RGBW	A+	IP20	
42	656090101	4017807389852	✓	1	SMD-LED	40	3700	RGBW	A+	IP20	
321	656210800	4017807371987	✓	1	SMD-LED	8	750	3000K	A+	IP20	92834-25
321	656211200	4017807371994	✓	1	SMD-LED	12	1100	3000K	A+	IP20	92834-30

Seite Page	Artikel-Nr. Product No.	EAN-Nummer EAN-Number	incl. 	#	Socket Fitting	Watt Watt	Lumen Lumen	Kelvin Kelvin	EEK (874/2012)	IP IP	Ersatzteile Spare parts
321	656211800	4017807372007	✓	1	SMD-LED	20	1800	3000K	A+	IP20	92834-40
320	656310800	4017807371956	✓	1	SMD-LED	8	750	4000K	A	IP20	
320	656311200	4017807371963	✓	1	SMD-LED	12	1100	4000K	A	IP20	
320	656311800	4017807371970	✓	1	SMD-LED	20	1800	4000K	A+	IP20	
317	656411506	4017807371796	✓	1	SMD-LED	15	1350	3000K	A+	IP44	
317	656412406	4017807371802	✓	1	SMD-LED	24	2000	3000K	A+	IP44	
317	656413006	4017807371819	✓	1	SMD-LED	30	2800	3000K	A+	IP44	
316	656511806	4017807371826	✓	1	SMD-LED	18	1650	3000K	A	IP44	
316	656512006	4017807371833	✓	1	SMD-LED	24	2000	3000K	A+	IP44	
317	656512406	4017807400144	✓	1	SMD-LED	24	2000	3000K	A+	IP44	
316	656513006	4017807371840	✓	1	SMD-LED	30	2800	3000K	A+	IP44	
348	656612001	4017807286281	✓	1	SMD-LED	20	1720	3000K	A	IP20	92731-20
348	656613001	4017807286298	✓	1	SMD-LED	30	2580	3000K	A	IP20	92731-30
348	656712001	4017807286304	✓	1	SMD-LED	20	1720	3000K	A	IP20	92732-20
348	656713001	4017807286311	✓	1	SMD-LED	30	2580	3000K	A	IP20	92732-30
346	656812079	4017807284188	✓	1	SMD-LED	20	1720	3000K	A	IP20	92724-79
346	656812089	4017807284195	✓	1	SMD-LED	20	1720	3000K	A	IP20	92724-89
346	656813079	4017807284201	✓	1	SMD-LED	30	2580	3000K	A	IP20	92725-79
346	656813089	4017807284218	✓	1	SMD-LED	30	2580	3000K	A	IP20	92725-79
319	657010601	4017807294637	✓	1	SMD-LED	5,5	450	3000K	A+	IP20	
319	657010607	4017807294675	✓	1	SMD-LED	5,5	450	3000K	A+	IP20	
319	657011201	4017807294712	✓	1	SMD-LED	11,5	1100	3000K	A+	IP20	
319	657011207	4017807294729	✓	1	SMD-LED	11,5	1100	3000K	A+	IP20	
319	657011801	4017807294743	✓	1	SMD-LED	17	1600	3000K	A+	IP20	
319	657011807	4017807294750	✓	1	SMD-LED	16,5	2000	3000K	A+	IP20	
319	657012401	4017807373516	✓	1	SMD-LED	24	1900	3000K	A	IP20	
319	657012407	4017807373523	✓	1	SMD-LED	24	1900	3000K	A	IP20	
318	657110601	4017807294651	✓	1	SMD-LED	5,5	450	3000K	A+	IP20	
318	657110607	4017807294668	✓	1	SMD-LED	5,5	450	3000K	A+	IP20	
318	657111201	4017807294705	✓	1	SMD-LED	12,5	1100	3000K	A+	IP20	
318	657111207	4017807294699	✓	1	SMD-LED	12,5	1100	3000K	A+	IP20	
318	657111801	4017807294767	✓	1	SMD-LED	17	1600	3000K	A+	IP20	
318	657111807	4017807294774	✓	1	SMD-LED	17	1600	3000K	A+	IP20	
318	657112401	4017807373530	✓	1	SMD-LED	24	2100	3000K	A+	IP20	
318	657112407	4017807373547	✓	1	SMD-LED	24	2100	3000K	A+	IP20	
293	657710100	4017807351149	✓	1	SMD-LED	21	2200	4000K	A+	IP20	
293	657810100	4017807351064	✓	1	SMD-LED	21	2200	4000K	A+	IP20	
293	657910100	4017807351101	✓	1	SMD-LED	21	2200	4000K	A+	IP20	
270	658010107	4017807354508	✓	1	SMD-LED	40	3800	3000-5500K	A+	IP20	
270	658090107	4017807354515	✓	1	SMD-LED	40	3800	3000-5500K	A+	IP20	
271	658110107	4017807354522	✓	1	SMD-LED	40	3800	3000-5500K	A+	IP20	
48	658210107	4017807389760	✓	1	SMD-LED	20	2000	RGBW	A+	IP20	
48	658210131	4017807389777	✓	1	SMD-LED	20	2000	RGBW	A+	IP20	
295	658311401	4017807300932	✓	1	SMD-LED	11	1000	3000K	A+	IP20	
295	658312601	4017807300949	✓	1	SMD-LED	21	2000	3000K	A+	IP20	
294	658412601	4017807300895	✓	1	SMD-LED	21	2000	3000K	A+	IP20	
294	658512601	4017807300901	✓	1	SMD-LED	21	2000	3000K	A+	IP20	
295	658611407	4017807300918	✓	1	SMD-LED	11	1000	3000K	A+	IP20	
295	658612607	4017807300925	✓	1	SMD-LED	21	2000	3000K	A+	IP20	
292	658714001	4017807302349	✓	1	SMD-LED	40	3600	3000-5500K	A+	IP20	
44	658810100	4017807389883	✓	1	SMD-LED	40	3700	RGBW	A+	IP20	
44	658810101	4017807389876	✓	1	SMD-LED	40	3700	RGBW	A+	IP20	
600	659011801	4017807280081	✓	1	SMD-LED	18	1600	3000K	A+	IP44	
600	659011887	4017807280098	✓	1	SMD-LED	18	1600	3000K	A+	IP44	
601	659411806	4017807280050	✓	1	SMD-LED	18	1600	3000K	A+	IP44	

Seite Page	Artikel-Nr. Product No.	EAN-Nummer EAN-Number	incl. 	#	Sockel Fitting	Watt Watt	Lumen Lumen	Kelvin Kelvin	EEK (874/2012)	IP IP	Ersatzteile Spare parts
601	659412406	4017807280074	✓	1	SMD-LED	24	2100	3000K	A	IP44	
268	659512405	4017807267228	✓	1	SMD-LED	24	2000	3000K	A	IP20	
268	659513605	4017807267235	✓	1	SMD-LED	30	3000	3000K	A+	IP20	
325	659611006	4017807267174	✓	1	SMD-LED	10	800	3000K	A+	IP20	92678-25
302	670010207	4017807384000	✓	2	SMD-LED	11	1250	3000K	A+	IP20	
302	670010231	4017807384017	✓	2	SMD-LED	11	1250	3000K	A+	IP20	
303	670110207	4017807383966	✓	2	SMD-LED	11	1250	3000K	A+	IP20	
303	670110231	4017807383973	✓	2	SMD-LED	11	1250	3000K	A+	IP20	
70	670610407	4017807299663	✓	4	SMD-LED	4,5	430	3000K	A+	IP20	
82	670910606	4017807330687	✓	6	SMD-LED	4,2	450	3000K	A+	IP20	
552	671010307	4017807357950	✓	3	E14	5	400	3000K	A+	IP20	92734
558	671410507	4017807261882	✓	5	E14	4	320	3000K	A+	IP20	92680
551	671510507	4017807285000	✓	5	G9	3,5	300	3000K	A+	IP20	92739
64	671610307	4017807391237	✓	3	SMD-LED	8,5	950	3000K	A+	IP20	
64	671610331	4017807391244	✓	3	SMD-LED	8,5	950	3000K	A+	IP20	
308	671810305	4017807294057	✓	3	SMD-LED	6	640	3000K	A+	IP20	
72	672212405	4017807297553	✓	1	SMD-LED	24	2400	3000K	A+	IP20	
304	672410531	4017807371932	✓	5	SMD-LED	3,5	250	3000K	A+	IP20	
304	672410731	4017807371949	✓	7	SMD-LED	3,5	250	3000K	A+	IP20	
116	672511006	4017807352856	✓	10	SMD-LED	2,3	240	3000K	A++	IP20	92805
58	672610331	4017807377477	✓	1	SMD-LED	35	3300	3000K	A+	IP20	
528	672610507	4017807353907	✓	5	SMD-LED	4,3	380	3000K	A+	IP20	
312	672710207	4017807352726	✓	2	SMD-LED	6	600	3000K	A+	IP20	
312	672710407	4017807352733	✓	4	SMD-LED	6	600	3000K	A+	IP20	
92	672910106	4017807299274	✓	1	SMD-LED	20	1800	3000K	A+	IP20	
152	673012489	4017807337464	✓	1	SMD-LED	24	2120	3000K	A+	IP20	92811-40
152	673013089	4017807337471	✓	1	SMD-LED	30	2650	3000K	A	IP20	92811-50
298	673210206	4017807388398	✓	1	SMD-LED	30	2800	3000K	A+	IP20	
298	673210231	4017807388404	✓	1	SMD-LED	30	2800	3000K	A+	IP20	
298	673210306	4017807388411	✓	1	SMD-LED	40	3600	3000K	A+	IP20	
298	673210331	4017807388428	✓	1	SMD-LED	40	3600	3000K	A+	IP20	
310	673311106	4017807351651	✓	10	SMD-LED	2,1	200	3000-6500K	A++	IP20	
			✓	1	SMD-LED	6,6	570	3000-6500K	A+		
310	673311306	4017807358407	✓	12	SMD-LED	2,1	200	3000-6500K	A++	IP20	
			✓	1	SMD-LED	6,6	570	3000-6500K	A+		
325	673411201	4017807342253	✓	1	SMD-LED	12	900	3000K	A	IP20	92790
325	673511201	4017807342260	✓	1	SMD-LED	12	900	3000K	A	IP20	92791
325	673611201	4017807342277	✓	1	SMD-LED	12	900	3000K	A	IP20	92792
402	673710207	4017807385236	✓	1	SMD-LED	26	3000	3000K	A+	IP20	
402	673710231	4017807385243	✓	1	SMD-LED	26	3000	3000K	A+	IP20	
402	673710232	4017807385250	✓	1	SMD-LED	26	3000	3000K	A+	IP20	
266	674011207	4017807363708	✓	1	SMD-LED	30	3000	3000K	A+	IP20	
266	674013007	4017807363630	✓	1	SMD-LED	15	1500	3000K	A+	IP20	
266	674014507	4017807363654	✓	1	SMD-LED	25	2500	3000K	A+	IP20	
266	674016207	4017807363692	✓	1	SMD-LED	30	3000	3000K	A+	IP20	
266	674093007	4017807363623	✓	1	SMD-LED	15	1500	3000K	A+	IP20	
266	674094507	4017807363647	✓	1	SMD-LED	25	2500	3000K	A+	IP20	
266	674096207	4017807363685	✓	1	SMD-LED	30	3000	3000K	A+	IP20	
264	674110687	4017807393613	✓	1	SMD-LED	32	3200	2700 - 6500K	A+	IP20	
264	674110887	4017807393620	✓	1	SMD-LED	45	5000	2700 - 6500K	A+	IP20	
264	674111187	4017807393637	✓	1	SMD-LED	55	6000	2700 - 6500K	A+	IP20	
96	674312406	4017807285925	✓	1	SMD-LED	24	2160	3000K	A+	IP20	
274	674510107	4017807381566	✓	1	SMD-LED	58	5400	3000 - 5500K	A+	IP20	
305	674610507	4017807385786	✓	3	SMD-LED	6	650	3000K	A+	IP20	
			✓	2	SMD-LED	3,5	350	3000K	A+		





Seite Page	Artikel-Nr. Product No.	EAN-Nummer EAN-Number	incl. 	#	Socket Fitting	Watt Watt	Lumen Lumen	Kelvin Kelvin	EEK (874/2012)	IP IP	Ersatzteile Spare parts
97	674910106	4017807306002	✓	1	SMD-LED	30	2200	3000+ 4400+6700K	A	IP20	
276	675010101	4017807358957	✓	1	SMD-LED	40	3800	3000-5500K	A+	IP20	92849-55
276	675070101	4017807363173	✓	1	SMD-LED	60	5300	3000-5500K	A+	IP20	92849-70
276	675090101	4017807358964	✓	1	SMD-LED	75	7000	3000-5500K	A+	IP20	92849
291	675310106	4017807363203	✓	1	SMD-LED	60	5800	3000-5500K	A+	IP20	
285	675610106	4017807363302	✓	1	SMD-LED	95	9600	3000-6000K	A+	IP20	
301	676210307	4017807371918	✓	1	SMD-LED	28	2600	3000K	A	IP20	
300	676290307	4017807371925	✓	1	SMD-LED	28	2600	3000K	A	IP20	
86	676310206	4017807298925	✓	4	SMD-LED	7	700	3000K	A+	IP20	
86	676310806	4017807302769	✓	4	SMD-LED	4,1	410	3000K	A+	IP20	
			✓	4	SMD-LED	2,8	280	3000K	A+		
98	676412406	4017807287264	✓	1	SMD-LED	24	2200	3000K	A	IP20	
98	676413606	4017807281620	✓	1	SMD-LED	32	3000	3000K	A+	IP20	
272	676611031	4017807398533	✓	1	SMD-LED	48	4300	3000-6000K	A+	IP20	
272	676615031	4017807398519	✓	1	SMD-LED	22	2100	3000-6000K	A+	IP20	
272	676617531	4017807398526	✓	1	SMD-LED	36	3300	3000-6000K	A+	IP20	
309	676712406	4017807305807	✓	1	SMD-LED	20	1800	3000K	A+	IP20	
340	677010307	4017807382020	✓	3	SMD-LED	3,6	380	3000K	A+	IP20	
341	677010379	4017807380514	✓	3	SMD-LED	3,6	380	3000K	A+	IP20	
340	677010507	4017807382037	✓	5	SMD-LED	3,6	380	3000K	A+	IP20	
341	677010579	4017807380521	✓	5	SMD-LED	3,6	380	3000K	A+	IP20	
340	677010607	4017807382044	✓	6	SMD-LED	3,6	380	3000K	A+	IP20	
341	677010679	4017807380538	✓	6	SMD-LED	3,6	380	3000K	A+	IP20	
324	677111001	4017807274400	✓	1	SMD-LED	10	800	3000K	A+	IP20	92708-01
324	677211006	4017807274448	✓	1	SMD-LED	10	800	3000K	A+	IP20	92708
324	677211087	4017807274431	✓	1	SMD-LED	10	800	3000K	A+	IP20	92708
323	677310907	4017807337396	✓	1	SMD-LED	9	810	3000K	A+	IP20	92797
323	677312007	4017807337426	✓	1	SMD-LED	20	1765	3000K	A+	IP20	92797-01
323	677410907	4017807337402	✓	1	SMD-LED	9	810	3000K	A+	IP20	92798
323	677412007	4017807337433	✓	1	SMD-LED	20	1800	3000K	A+	IP20	92798-01
290	677610106	4017807355345	✓	1	SMD-LED	30	2100	3000-5500K	A	IP20	
66	677610606	4017807274561	✓	6	SMD-LED	5	500	3000K	A+	IP20	
290	677690106	4017807355352	✓	1	SMD-LED	60	4500	3000-5500K	A	IP20	
284	677718000	4017807337686	✓	1	SMD-LED	80	6400	3000-5500K	A	IP20	92804
200	678010107	4017807401127	✓	1	SMD-LED	24	2100	3000K	A+	IP20	
200	678010108	4017807401134	✓	1	SMD-LED	24	2100	3000K	A+	IP20	
122	678310306	4017807357943	✓	3	SMD-LED	3,8	350	3000K	A+	IP20	
122	678310506	4017807336757	✓	5	SMD-LED	3,8	350	3000K	A+	IP20	
122	678310606	4017807336764	✓	6	SMD-LED	3,8	350	3000K	A+	IP20	
282	678710006	4017807337730	✓	1	SMD-LED	100	9800	3000-6000K	A+	IP20	
282	678711206	4017807337716	✓	1	SMD-LED	12	1050	3000K	A+	IP20	
282	678713006	4017807337723	✓	1	SMD-LED	30	3100	3000-6000K	A+	IP20	
286	679310107	4017807372489	✓	1	SMD-LED	29	2850	3000-5000K	A+	IP20	
600	6801011-01	4017807259056		1	E27	max. 60			A++ ... E	IP44	
600	6801011-06	4017807147575		1	E27	max. 60			A++ ... E	IP44	9580
600	6801011-07	4017807147582		1	E27	max. 60			A++ ... E	IP44	9580
599	680611206	4017807246056	✓	4	SMD-LED	4,5	400	3000K	A+	IP44	92599
599	680711206	4017807246049	✓	3	SMD-LED	4,5	430	3000K	A+	IP44	92600
599	681910406	4017807244854	✓	4	SMD-LED	4,5	400	3000K	A+	IP44	92651
586	682310306	4017807286274	✓	3	SMD-LED	4,5	430	3000K	A+	IP44	92736
588	682410506	4017807280845	✓	5	SMD-LED	3,2	300	3000K	A+	IP44	
590	683310306	4017807391848	✓	3	SMD-LED	4,3	430	3000K	A+	IP44	
590	683310307	4017807384192	✓	3	SMD-LED	4,3	430	3000K	A+	IP44	
541	770010587	4017807287196	✓	5	GU5.3	3	260	3000K	A+	IP20	

Seite Page	Artikel-Nr. Product No.	EAN-Nummer EAN-Number	incl. 	#	Socket Fitting	Watt Watt	Lumen Lumen	Kelvin Kelvin	EEK (874/2012)	IP IP	Ersatzteile Spare parts
541	774110506	4017807287172	✓	5	SMD-LED	3,8	350	3000K	A+	IP20	
538	775810506	4017807305043	✓	5	SMD-LED	4,1	330	3000K	A+	IP20	
538	775910506	4017807285994	✓	5	SMD-LED	3,8	350	3000K	A+	IP20	
540	777710506	4017807305050	✓	5	SMD-LED	4,1	330	3000K	A+	IP20	
541	778210506	4017807281576	✓	5	SMD-LED	3,8	350	3100K	A+	IP20	
538	779310507	4017807336894	✓	5	SMD-LED	2,5	245	3000K	A++	IP20	
539	779310707	4017807336900	✓	7	SMD-LED	2,5	245	3000K	A++	IP20	
570	800300132	4017807351392		1	E14	max. 40			A++ ... E	IP20	
570	800300232	4017807351415		2	E14	max. 40			A++ ... E	IP20	
570	800300332	4017807351620		3	E14	max. 40			A++ ... E	IP20	
570	800300432	4017807351644		4	E14	max. 40			A++ ... E	IP20	
569	801000106	4017807231632		1	E14	max. 40			A++ ... E	IP20	92505 92505-01
569	801000206	4017807231649		2	E14	max. 40			A++ ... E	IP20	92505 92505-01
569	801000306	4017807231656		3	E14	max. 40			A++ ... E	IP20	92505 92505-01
569	801000406	4017807231663		4	E14	max. 40			A++ ... E	IP20	92505 92505-04
154	801500107	4017807388824		1	E14	max. 28			A++ ... E	IP20	
154	801500207	4017807388831		2	E14	max. 28			A++ ... E	IP20	
154	801500307	4017807388848		3	E14	max. 28			A++ ... E	IP20	
154	801500407	4017807388855		4	E14	max. 28			A++ ... E	IP20	
564	802400101	4017807227543		1	GU10	max. 35			A++ ... E	IP20	
564	802400107	4017807231335		1	GU10	max. 35			A++ ... E	IP20	
564	802400201	4017807227550		2	GU10	max. 35			A++ ... E	IP20	
564	802400207	4017807231359		2	GU10	max. 35			A++ ... E	IP20	
564	802400301	4017807227567		3	GU10	max. 35			A++ ... E	IP20	
564	802400307	4017807231373		3	GU10	max. 35			A++ ... E	IP20	
564	802430401	4017807227574		4	GU10	max. 35			A++ ... E	IP20	
564	802430407	4017807231397		4	GU10	max. 35			A++ ... E	IP20	
560	802500178	4017807299519		1	GU10	max. 42			A++ ... E	IP20	
560	802500278	4017807299526		2	GU10	max. 42			A++ ... E	IP20	
560	802500378	4017807299540		3	GU10	max. 42			A++ ... E	IP20	
560	802530478	4017807353808		4	GU10	max. 42			A++ ... E	IP20	
562	802600107	4017807335583		1	GU10	max. 25			A++ ... E	IP20	
562	802600207	4017807335590		2	GU10	max. 25			A++ ... E	IP20	
562	802600307	4017807335606		3	GU10	max. 25			A++ ... E	IP20	
562	802600407	4017807335637		4	GU10	max. 25			A++ ... E	IP20	
566	803000107	4017807348262		1	GU10	max. 28			A++ ... E	IP20	
566	803000207	4017807348279		2	GU10	max. 28			A++ ... E	IP20	
566	803000307	4017807348286		3	GU10	max. 28			A++ ... E	IP20	
566	803000407	4017807348309		4	GU10	max. 28			A++ ... E	IP20	
566	803000607	4017807348293		6	GU10	max. 28			A++ ... E	IP20	
566	803080107	4017807348330		1	GU10	max. 18			A++ ... E	IP20	
566	803090307	4017807348323		3	GU10	max. 28			A++ ... E	IP20	
156	803100104	4017807353235		1	E14	max. 40			A++ ... E	IP20	92812-01
156	803100107	4017807353242		1	E14	max. 40			A++ ... E	IP20	92812-01
156	803100204	4017807353259		2	E14	max. 40			A++ ... E	IP20	92812-01
156	803100207	4017807353266		2	E14	max. 40			A++ ... E	IP20	92812-01
156	803100304	4017807353273		3	E14	max. 40			A++ ... E	IP20	92812-01
156	803100307	4017807353280		3	E14	max. 40			A++ ... E	IP20	92812-01
156	803100404	4017807353297		4	E14	max. 40			A++ ... E	IP20	92812-01
156	803100407	4017807353303		4	E14	max. 40			A++ ... E	IP20	92812-01
176	804600331	4017807374780		3	G9	max. 28			A++ ... E	IP20	

Seite Page	Artikel-Nr. Product No.	EAN-Nummer EAN-Number	incl. 	#	Sockel Fitting	Watt Watt	Lumen Lumen	Kelvin Kelvin	EEK (874/2012)	IP IP	Ersatzteile Spare parts
176	804600332	4017807374797		3	G9	max. 28			A++ ... E	IP20	
176	804600431	4017807374803		4	G9	max. 28			A++ ... E	IP20	
176	804600432	4017807374810		4	G9	max. 28			A++ ... E	IP20	
176	804670131	4017807374742		1	G9	max. 28			A++ ... E	IP20	
176	804670132	4017807374759		1	G9	max. 28			A++ ... E	IP20	
176	804670231	4017807374766		2	G9	max. 28			A++ ... E	IP20	
176	804670232	4017807374773		2	G9	max. 28			A++ ... E	IP20	
240	805000130	4017807353730		1	E14	max. 28			A++ ... E	IP20	
240	805000230	4017807353747		2	E14	max. 28			A++ ... E	IP20	
240	805000330	4017807353754		3	E14	max. 28			A++ ... E	IP20	
240	805000430	4017807353761		4	E14	max. 28			A++ ... E	IP20	
376	8160211-07	4017807115772		1	G9	max. 28			A++ ... E	IP20	9461
376	8160911-07	4017807115789		1	G9	max. 28			A++ ... E	IP20	9461
568	818000206	4017807203059		2	GU10	max. 25			A++ ... E	IP20	
568	818000306	4017807203066		3	GU10	max. 25			A++ ... E	IP20	
568	818000406	4017807203073		4	GU10	max. 25			A++ ... E	IP20	
568	818000606	4017807203080		6	GU10	max. 25			A++ ... E	IP20	
568	818070106	4017807203042		1	GU10	max. 25			A++ ... E	IP20	
522	821410305	4017807220902	✓	3	SMD-LED	4,5	400	3000K	A+	IP20	92426
522	821410405	4017807220919	✓	4	SMD-LED	4,5	400	3000K	A+	IP20	92426
522	821410605	4017807220933	✓	6	SMD-LED	4,5	400	3000K	A+	IP20	92426
523	821430405	4017807220926	✓	4	SMD-LED	4,5	400	3000K	A+	IP20	92426
522	821470105	4017807220889	✓	1	SMD-LED	4,5	400	3000K	A+	IP20	92426
522	821470205	4017807220896	✓	2	SMD-LED	4,5	400	3000K	A+	IP20	92426
556	824810107	4017807257526	✓	1	E14	4	320	3000K	A+	IP20	98249 98248
556	824810128	4017807257809	✓	1	E14	4	320	3000K	A+	IP20	98249 98248
556	824810207	4017807257540	✓	2	E14	4	320	3000K	A+	IP20	98249 98248
556	824810228	4017807257816	✓	2	E14	4	320	3000K	A+	IP20	98249 98248
556	824810307	4017807257564	✓	3	E14	4	320	3000K	A+	IP20	98249 98248
556	824810328	4017807257823	✓	3	E14	4	320	3000K	A+	IP20	98249 98248
556	824810407	4017807257588	✓	4	E14	4	320	3000K	A+	IP20	98249 98248
556	824810428	4017807257830	✓	4	E14	4	320	3000K	A+	IP20	98249 98248
556	824810607	4017807257601	✓	6	E14	4	320	3000K	A+	IP20	98249 98248
556	824810628	4017807257847	✓	6	E14	4	320	3000K	A+	IP20	98249 98248
530	827830431	4017807383843	✓	4	SMD-LED	6	550	3000K	A+	IP20	
530	827830432	4017807383850	✓	4	SMD-LED	6	550	3000K	A+	IP20	
530	827890131	4017807383751	✓	1	SMD-LED	8	730	3000K	A+	IP20	
530	827890132	4017807383768	✓	1	SMD-LED	8	730	3000K	A+	IP20	
530	827890231	4017807383782	✓	2	SMD-LED	6	550	3000K	A+	IP20	
530	827890232	4017807383799	✓	2	SMD-LED	6	550	3000K	A+	IP20	
530	827890331	4017807383812	✓	3	SMD-LED	6	550	3000K	A+	IP20	
530	827890332	4017807383829	✓	3	SMD-LED	6	550	3000K	A+	IP20	
544	828210106	4017807236767	✓	1	SMD-LED	3,8	350	3100K	A+	IP20	
544	828210206	4017807236774	✓	2	SMD-LED	3,8	350	3100K	A+	IP20	
544	828210306	4017807236781	✓	3	SMD-LED	3,8	350	3100K	A+	IP20	

Seite Page	Artikel-Nr. Product No.	EAN-Nummer EAN-Number	incl. 	#	Sockel Fitting	Watt Watt	Lumen Lumen	Kelvin Kelvin	EEK (874/2012)	IP IP	Ersatzteile Spare parts
544	828210406	4017807236798	✓	4	SMD-LED	3,8	350	3100K	A+	IP20	
544	828210606	4017807236804	✓	6	SMD-LED	3,8	350	3100K	A+	IP20	
545	828280106	4017807240542	✓	1	SMD-LED	3,8	350	3100K	A+	IP20	
518	828510307	4017807378238	✓	2	SMD-LED	4,3	430	3000K	A+	IP20	
			✓	1	SMD-LED	4	330	3000K	A+		
518	828510331	4017807378221	✓	2	SMD-LED	4,3	430	3000K	A+	IP20	
			✓	1	SMD-LED	4	330	3000K	A+		
518	828510407	4017807378252	✓	3	SMD-LED	4,3	430	3000K	A+	IP20	
			✓	1	SMD-LED	8	640	3000K	A+		
518	828510431	4017807378245	✓	3	SMD-LED	4,3	430	3000K	A+	IP20	
			✓	1	SMD-LED	8	640	3000K	A+		
518	828510507	4017807378276	✓	4	SMD-LED	4,3	430	3000K	A+	IP20	
			✓	1	SMD-LED	8	640	3000K	A+		
518	828510531	4017807378269	✓	4	SMD-LED	4,3	430	3000K	A+	IP20	
			✓	1	SMD-LED	8	640	3000K	A+		
518	828530507	4017807378290	✓	4	SMD-LED	4,3	430	3000K	A+	IP20	
			✓	1	SMD-LED	8	640	3000K	A+		
518	828530531	4017807378283	✓	4	SMD-LED	4,3	430	3000K	A+	IP20	
			✓	1	SMD-LED	8	640	3000K	A+		
518	828570207	4017807378214	✓	1	SMD-LED	4,3	430	3000K	A+	IP20	
			✓	1	SMD-LED	3	280	3000K	A+		
518	828570231	4017807378207	✓	1	SMD-LED	4,3	430	3000K	A+	IP20	
			✓	1	SMD-LED	3	280	3000K	A+		
520	829210201	4017807256888	✓	2	SMD-LED	4,5	430	3000K	A+	IP20	
520	829210301	4017807256895	✓	3	SMD-LED	4,5	430	3000K	A+	IP20	
520	829210401	4017807260496	✓	4	SMD-LED	4,5	430	3000K	A+	IP20	
520	829230401	4017807256901	✓	4	SMD-LED	4,5	430	3000K	A+	IP23	
520	829270101	4017807256871	✓	1	SMD-LED	4,5	430	3000K	A+	IP20	
526	829910107	4017807302721	✓	1	SMD-LED	6	470	3000K	A	IP20	
526	829910207	4017807302738	✓	2	SMD-LED	6	470	3000K	A	IP20	
526	829910307	4017807302745	✓	3	SMD-LED	6	470	3000K	A	IP20	
526	829910407	4017807302752	✓	4	SMD-LED	6	470	3000K	A	IP20	
50	850010131	4017807389890	✓	1	SMD-LED	3	300	RGBW	A+	IP20	
50	850010132	4017807389906	✓	1	SMD-LED	3	300	RGBW	A+	IP20	
50	850010231	4017807389913	✓	2	SMD-LED	3	300	RGBW	A+	IP20	
50	850010232	4017807389920	✓	2	SMD-LED	3	300	RGBW	A+	IP20	
50	850010331	4017807389937	✓	3	SMD-LED	3	300	RGBW	A+	IP20	
50	850010332	4017807389944	✓	3	SMD-LED	3	300	RGBW	A+	IP20	
50	850010431	4017807389951	✓	4	SMD-LED	3	300	RGBW	A+	IP20	
50	850010432	4017807389968	✓	4	SMD-LED	3	300	RGBW	A+	IP20	
70	870610207	4017807299632	✓	2	SMD-LED	4,5	430	3000K	A+	IP20	
70	870610307	4017807299649	✓	3	SMD-LED	4,5	430	3000K	A+	IP20	
70	870610407	4017807299656	✓	4	SMD-LED	4,5	430	3000K	A+	IP20	
70	870670107	4017807299625	✓	1	SMD-LED	4,5	430	3000K	A+	IP20	
552	871010107	4017807281637	✓	1	E14	5	400	3000K	A+	IP20	92734
552	871010108	4017807281644	✓	1	E14	5	400	3000K	A+	IP20	92734
552	871010207	4017807281651	✓	2	E14	5	400	3000K	A+	IP20	92734
552	871010208	4017807281668	✓	2	E14	5	400	3000K	A+	IP20	92734
552	871010307	4017807281675	✓	3	E14	5	400	3000K	A+	IP20	92734
552	871010308	4017807281682	✓	3	E14	5	400	3000K	A+	IP20	92734
554	871010407	4017807281712	✓	4	E14	5	400	3000K	A+	IP20	92734
554	871010408	4017807281729	✓	4	E14	5	400	3000K	A+	IP20	92734
554	871010607	4017807281736	✓	6	E14	5	400	3000K	A+	IP20	92734
554	871010608	4017807281743	✓	6	E14	5	400	3000K	A+	IP20	92734
554	871090307	4017807281699	✓	3	E14	5	400	3000K	A+	IP20	92734

Seite Page	Artikel-Nr. Product No.	EAN-Nummer EAN-Number	incl. 	#	Sockel Fitting	Watt Watt	Lumen Lumen	Kelvin Kelvin	EEK (874/2012)	IP IP	Ersatzteile Spare parts
554	871090308	4017807281705	✓	3	E14	5	400	3000K	A+	IP20	92734
558	871410107	4017807261820	✓	1	E14	4	320	3000K	A+	IP20	92680
558	871410207	4017807261837	✓	2	E14	4	320	3000K	A+	IP20	92680
558	871410307	4017807261844	✓	3	E14	4	320	3000K	A+	IP20	92680
558	871410407	4017807261851	✓	4	E14	4	320	3000K	A+	IP20	92680
558	871410607	4017807261868	✓	6	E14	4	320	3000K	A+	IP20	92680
550	871510207	4017807284904	✓	2	G9	3,5	300	3000K	A+	IP20	92739
550	871510208	4017807297744	✓	2	G9	3,5	300	3000K	A+	IP20	92739
550	871510407	4017807284966	✓	4	G9	3,5	300	3000K	A+	IP20	92739
550	871510408	4017807297768	✓	4	G9	3,5	300	3000K	A+	IP20	92739
550	871510607	4017807284980	✓	6	G9	3,5	300	3000K	A+	IP20	92739
550	871510608	4017807297775	✓	6	G9	3,5	300	3000K	A+	IP20	92739
550	871570107	4017807284898	✓	1	G9	3,5	300	3000K	A+	IP20	92739
550	871570108	4017807297737	✓	1	G9	3,5	300	3000K	A+	IP20	92739
550	871590307	4017807284942	✓	3	G9	3,5	300	3000K	A+	IP20	92739
550	871590308	4017807297751	✓	3	G9	3,5	300	3000K	A+	IP20	92739
308	871810205	4017807294033	✓	2	SMD-LED	11	1100	3000K	A+	IP20	
308	871810405	4017807294040	✓	4	SMD-LED	11	1100	3000K	A+	IP20	
114	872110207	4017807338324	✓	2	SMD-LED	4,3	400	3000K	A+	IP20	
114	872110307	4017807338331	✓	3	SMD-LED	4,3	400	3000K	A+	IP20	
114	872110407	4017807338355	✓	4	SMD-LED	4,3	400	3000K	A+	IP20	
114	872170107	4017807338317	✓	1	SMD-LED	4,3	400	3000K	A+	IP20	
528	872610407	4017807353891	✓	4	SMD-LED	4,3	380	3000K	A+	IP20	
528	872670107	4017807353860	✓	1	SMD-LED	4,3	380	3000K	A+	IP20	
528	872670207	4017807353877	✓	2	SMD-LED	4,3	380	3000K	A+	IP20	
528	872670307	4017807353884	✓	3	SMD-LED	4,3	380	3000K	A+	IP20	
548	872810101	4017807262209	✓	1	SMD-LED	3,8	350	3100K	A+	IP20	
546	872810106	4017807262216	✓	1	SMD-LED	3,8	350	3100K	A+	IP20	
548	872810201	4017807262223	✓	2	SMD-LED	3,8	350	3100K	A+	IP20	
546	872810206	4017807262230	✓	2	SMD-LED	3,8	350	3100K	A+	IP20	
548	872810401	4017807262261	✓	4	SMD-LED	3,8	350	3100K	A+	IP20	
546	872810406	4017807262278	✓	4	SMD-LED	3,8	350	3100K	A+	IP20	
548	872810601	4017807262308	✓	6	SMD-LED	3,8	350	3100K	A+	IP20	
546	872810606	4017807262315	✓	6	SMD-LED	3,8	350	3100K	A+	IP20	
549	872830301	4017807262247	✓	3	SMD-LED	3,8	350	3100K	A+	IP20	
546	872830306	4017807262254	✓	3	SMD-LED	3,8	350	3100K	A+	IP20	
532	873110307	4017807302615	✓	3	SMD-LED	6	550	3000K	A+	IP20	
534	873110331	4017807302622	✓	3	SMD-LED	6	550	3000K	A+	IP20	
532	873110407	4017807302639	✓	4	SMD-LED	6	550	3000K	A+	IP20	
534	873110431	4017807302646	✓	4	SMD-LED	6	550	3000K	A+	IP20	
532	873110607	4017807302653	✓	6	SMD-LED	6	550	3000K	A+	IP20	
534	873110631	4017807302660	✓	6	SMD-LED	6	550	3000K	A+	IP20	
532	873170107	4017807302578	✓	1	SMD-LED	6	550	3000K	A+	IP20	
534	873170131	4017807302585	✓	1	SMD-LED	6	550	3000K	A+	IP20	
532	873170207	4017807302592	✓	2	SMD-LED	6	550	3000K	A+	IP20	
534	873170231	4017807302608	✓	2	SMD-LED	6	550	3000K	A+	IP20	
122	878310106	4017807336719	✓	1	SMD-LED	3,8	350	3000K	A+	IP20	
122	878310206	4017807336726	✓	2	SMD-LED	3,8	350	3000K	A+	IP20	
122	878310306	4017807336733	✓	3	SMD-LED	3,8	350	3000K	A+	IP20	
122	878310406	4017807336740	✓	4	SMD-LED	3,8	350	3000K	A+	IP20	
524	878610206	4017807281989	✓	2	SMD-LED	4,5	430	3000K	A+	IP20	92766
524	878610306	4017807281996	✓	3	SMD-LED	4,5	430	3000K	A+	IP20	92766
524	878610406	4017807282009	✓	4	SMD-LED	4,5	430	3000K	A+	IP20	92766
524	878610606	4017807282016	✓	6	SMD-LED	4,5	430	3000K	A+	IP20	92766
524	878670106	4017807281972	✓	1	SMD-LED	4,5	430	3000K	A+	IP20	92766

Seite Page	Artikel-Nr. Product No.	EAN-Nummer EAN-Number	incl. 	#	Sockel Fitting	Watt Watt	Lumen Lumen	Kelvin Kelvin	EEK (874/2012)	IP IP	Ersatzteile Spare parts
536	879310107	4017807336825	✓	1	SMD-LED	3,5	340	3000K	A++	IP20	
536	879310207	4017807336832	✓	2	SMD-LED	3,5	340	3000K	A++	IP20	
536	879310407	4017807336856	✓	4	SMD-LED	3,5	340	3000K	A++	IP20	
536	879310607	4017807336863	✓	6	SMD-LED	3,5	340	3000K	A++	IP20	
536	879390307	4017807336849	✓	3	SMD-LED	3,5	340	3000K	A++	IP20	
596	8801211-06	4017807147469		1	G9	max. 28			A++ ... E	IP21	9574
383	891010107	4017807358049	✓	1	E14	6	470	3000K	A+	IP20	92734
382	8911211-07	4017807118780		1	E14	max. 40			A++ ... E	IP20	9568-07
382	891770107	4017807358162	✓	1	G9	3,5	320	3000K	A+	IP20	92816
382	899670107	4017807358155	✓	1	GU10	5	400	3000K	A+	IP20	
606	916-30	4017807287189		1	GU5.3	3	260	3000K	A+	IPX0	
606	955-50	4017807277074		1	GU10	5	400	3000K	A+	IPX0	
606	955-55	4017807277098		1	E14	5	400	3000K	A+	IPX0	
606	956-30	4017807277050		1	GU10	3	250	3000K	A+	IPX0	
604	956-55	4017807300369		1	GU10	5	400	3000K	A+	IPX0	
55	956-88	4017807388350		1	GU10	6,5	360	RGBW	A	IPX0	
605	983-40	4017807240566		1	E14	4	320	3000K	A+	IPX0	
605	983-43	4017807260540		1	E14	4	320	3000K	A+	IPX0	
605	983-56	4017807394863		1	E14	5	400	3000K	A+	IPX0	
605	983-60	4017807279214		1	E14	5	400	3000K	A+	IPX0	
605	983-63	4017807279221		1	E14	5	400	3000K	A+	IPX0	
604	983-66	4017807300345		1	E14	6	470	3000K	A+	IPX0	
55	983-88	4017807388367		1	E14	7,5	470	RGBW	A	IPX0	
605	986-40	4017807268782		1	E27	4	320	3000K	A+	IPX0	
605	986-43	4017807268799		1	E27	4	320	3000K	A+	IPX0	
605	986-60	4017807280647		1	E27	5	400	3000K	A+	IPX0	
605	986-63	4017807280654		1	E27	5	400	3000K	A+	IPX0	
605	987-60	4017807279252		1	E27	6	470	3000K	A+	IPX0	
55	987-88	4017807388374		1	E27	11,5	806	RGBW	A	IPX0	
604	988-10	4017807300338		1	E27	10	806	3000K	A+	IPX0	
605	989-40	4017807240597		1	E14	4	320	3000K	A+	IPX0	
605	989-43	4017807260557		1	E14	4	320	3000K	A+	IPX0	
605	989-56	4017807394870		1	E14	5	400	3000K	A+	IPX0	
605	989-60	4017807279238		1	E14	6	470	3000K	A+	IPX0	
605	989-63	4017807279245		1	E14	6	470	3000K	A+	IPX0	
604	989-66	4017807300352		1	E14	6	470	3000K	A+	IPX0	
605	990-40	4017807240610		1	E14	4	320	3000K	A+	IPX0	
609	901-479	4017807351446		1	E27	4	320	2700K	A+	IPX0	
609	902-479	4017807351453		1	E27	4	320	2700K	A+	IPX0	
609	903-479	4017807351460		1	E27	4	320	2700K	A+	IPX0	
609	904-479	4017807351477		1	E27	4	320	2700K	A+	IPX0	
609	905-479	4017807351484		1	E27	4	320	2700K	A+	IPX0	
609	906-879	4017807382655		1	E27	8	560	2700K	A+	IPX0	
609	907-879	4017807382662		1	E27	8	560	2700K	A+	IPX0	
609	908-879	4017807382716		1	E27	8	560	2700K	A+	IPX0	
606	929-220	4017807293319		1	G9	2,5	210	3000K	A++	IPX0	
604	929-230	4017807355000		1	G9	3,5	320	3000K	A+	IPX0	
606	929-235	4017807283143		1	G9	3	250	3000K	A+	IPX0	
608	983-400	4017807302097		1	E14	4	470	3000K	A++	IPX0	
605	983-410	4017807394900		1	E14	4	450	2800K	A+	IPX0	
608	987-400	4017807287509		1	E27	4	400	3000K	A++	IPX0	
605	987-410	4017807394917		1	E27	4	450	2800K	A+	IPX0	
608	987-600	4017807288056		1	E27	6	600	3000K	A+	IPX0	
608	987-660	4017807300314		1	E27	6	600	3000K	A+	IPX0	
608	987-679	4017807288049		1	E27	6	420	2700K	A+	IPX0	

Seite Page	Artikel-Nr. Product No.	EAN-Nummer EAN-Number	incl. 	#	Socket Fitting	Watt Watt	Lumen Lumen	Kelvin Kelvin	EEK (874/2012)	IP IP	Ersatzteile Spare parts
605	988-110	4017807394894		1	E27	10	800	3000K	A+	IPX0	
608	988-600	4017807287516		1	E27	6	600	3000K	A+	IPX0	
608	988-660	4017807300321		1	E27	6	600	3000K	A+	IPX0	
608	988-679	4017807287530		1	E27	6	420	2700K	A+	IPX0	
605	988-700	4017807394887		1	E27	7	560	3000K	A+	IPX0	
608	989-400	4017807287486		1	E14	4	400	3000K	A++	IPX0	
608	989-479	4017807287523		1	E14	4	280	2700K	A+	IPX0	
608	990-400	4017807287493		1	E14	4	400	3000K	A++	IPX0	
606	929-2300	4017807394924		1	G9	3	300	3000K	A++	IPX0	
604	956-5736	4017807380057		1	GU10	5	400	3000K	A+	IPX0	
606	956-5936	4017807380071		1	GU10	5	400	3000K	A+	IPX0	
607	983-4470	4017807358940		1	E14	4	470	2700K	A++	IPX0	
607	985-6810	4017807358759		1	E27	6	810	2700K	A++	IPX0	
607	986-6810	4017807358766		1	E27	6	810	2700K	A++	IPX0	
608	987-2400	4017807303933		1	E27	4	470	3000K	A++	IPX0	
607	987-6700	4017807387636		1	E27	8	700	2700K	A+	IPX0	
607	987-6810	4017807358735		1	E27	8	806	2700K	A+	IPX0	
607	989-4470	4017807358926		1	E14	4	470	2700K	A++	IPX0	
607	990-4470	4017807358933		1	E14	4	470	2700K	A++	IPX0	

TRIO behält sich das Recht vor, zu jeder Zeit, notwendige Änderungen oder Aktualisierungen der in diesem Katalog enthaltenen Produkte vorzunehmen. · TRIO reserves the right to carry out any time, necessary changes or updates of the products in this catalogue. · TRIO se réserve le droit d'apporter à tout moment les modifications ou actualisations nécessaires aux produits dans ce catalogue. · TRIO behoudt zich het recht voor op ieder moment noodzakelijke wijzigingen of updates aan de producten in deze catalogus door te voeren. · TRIO se reserva , en todo momento, el derecho a realizar las modificaciones o actualizaciones que considere necesarias para cualquier producto de este catálogo. · TRIO si riserva il diritto di apportare, in qualunque momento, tutte le modifiche necessarie ai prodotti di questo catalogo. · TRIO-ul își rezervă dreptul de a face oricând orice modificări sau actualizări necesare pentru produsele din acest catalog. · TRIO pidättää oikeuden tehdä muutoksia tai päivittää tuotteita tässä luettelossa. · TRIO zastrzega sobie prawo do wprowadzania w dowolnym czasie zmian lub aktualizacji produktów zawartych w katalogu. · TRIO bu katalog ürünleri için gerekli güncellemeleri ve düzenlemeleri herhangi bir zamanda yapma hakkını saklı tutar.

# Kontakte

Contact · Contact · Contact · Contactar · Contatto · Contact · Yhteydenotto · Kontakt · İletişim

## TRIO Leuchten GmbH

Dieselstraße 4  
D-59823 Arnsberg

T +49 2931 9666-0  
F +49 2931 9666-57

info@trio-leuchten.de  
www.trio-leuchten.de



## Niedersachsen, Schleswig-Holstein

### Jens Gebers

T +49 170 1615227  
jens.gebers@trio-leuchten.de



## Österreich

### Wolfgang Melich

T +43 660 5161228  
wolfgang.melich@trio-leuchten.de

## Nordrhein-Westfalen

### Antonio Capizzi

T +49 172 2598392  
capizziantonio@aol.com



## Schweiz

### TRIO Leuchten GmbH

T +49 2931 9666-0  
info@trio-leuchten.de

## Saarland, Rheinland-Pfalz, Hessen

### Christian Teller

T +49 171 4521820  
christian.teller@trio-leuchten.de

## Baden Württemberg

### Antonio De Simone

T +49 151 58555222  
antonio.desimone@trio-leuchten.de

## Bayern, Hessen

### Martin Kluge

T +49 171 7300330  
martin.kluge@trio-leuchten.de

## Berlin, Brandenburg, Meckl.-Vorpommern, Sachsen, Sachsen Anhalt, Thüringen

### Jörg Bumke

T +49 160 7406860  
joerg.bumke@trio-leuchten.de





## TRIO International GmbH

Dieselstraße 4  
D-59823 Arnsberg

T +49 2931 9666-587

F +49 2931 9666-56

info@trio-lighting.com

www.trio-lighting.com



### France

#### Christophe Meulien

info.france@trio-lighting.com

*Agent exclusif pour les départements*

04, 05, 06, 11, 13, 30, 34, 48, 66, 83 et 84

#### Michel Salamand

info.france@trio-lighting.com

*Agent exclusif pour les départements*

14, 17, 22, 29, 35, 36, 37, 41, 44, 49, 50, 53,  
56, 61, 72, 79, 85 et 86

#### Jean Louis Briche

info.france@trio-lighting.com

*Agent exclusif pour les départements*

02, 08, 10, 18, 21, 25, 27, 28, 39, 45, 51, 52, 54,  
55, 57, 58, 59, 60, 62, 67, 68, 70, 75, 77, 78, 80,  
88, 89, 90, 91, 92, 94 et 95

#### Jean Barel

info.france@trio-lighting.com

*Agent exclusif pour les départements*

09, 12, 15, 16, 19, 24, 31, 32, 33, 40, 46, 47, 64,  
65, 81, 82 et 87

#### Jean Marc Bossonney

info.france@trio-lighting.com

*Agent exclusif pour les départements*

01, 03, 07, 26, 38, 42, 43, 63, 69, 71, 73 et 74

#### Anne Briard

info.france@trio-lighting.com

*Agent exclusif pour les départements*

2a et 2b



### Nederland

Karl Stok / Bas Martin

info.nederland@trio-lighting.com



### Belgium/Belgique

Yves van den Berghe

info.belgium@trio-lighting.com



### Romania

Gina Ionita

info.romania@trio-lighting.com



### Italia

#### TRIO Lighting Italia s.r.l

Via Padre Masciadri, 2 H

IT-22066 Mariano Comense (CO)

T +39 (0) 317 477 55

F +39 (0) 313 551 560

info.italia@trio-lighting.com



### España

#### Trio Lighting Ibèrica SL

C/ Can Lietget n°9 nave9

Pol. Ind. Can Roqueta

08206 Sabadell

T +34 (0) 9 35 45 86 30

F +34 (0) 9 33 96 45 48

E-Mail: info.iberica@trio-lighting.com



### Suomi

#### TRIO Lighting Scandinavia Oy

Malmin raitti, rappu 17 B

00700 Helsinki

T +358 (0) 10 23 13 390

F +358 (0) 10 23 13 399

info.scandinavia@trio-lighting.com

*Our Scandinavian organisation represents TRIO also in  
DENMARK, SWEDEN, NORWAY, ESTONIA, LATVIA and  
LITHUANIA*



### Great Britain

#### TRIO Lighting UK Ltd.

Unit 5, Hemmells Park Hemmells, Laindon

Essex

SS1s 6GF

T +44 (0) 12 68 88 95 95

F +44 (0) 12 68 88 95 96

sales@triolightinguk.com

lichtforumrw

[www.lichtforumrw.de](http://www.lichtforumrw.de)

LICHTWOCHE  
SAUERLAND   
10. - 14.03.2019





---

#### **TRIO Leuchten GmbH**

Dieselstraße 4  
D-59823 Arnsberg

T +49 2931 9666-0  
F +49 2931 9666-28

[info@trio-leuchten.de](mailto:info@trio-leuchten.de)  
[www.trio-leuchten.de](http://www.trio-leuchten.de)

#### **TRIO International GmbH**

Dieselstraße 4  
D-59823 Arnsberg

T +49 2931 9666-587  
F +49 2931 9666-56

[info@trio-lighting.com](mailto:info@trio-lighting.com)  
[www.trio-lighting.com](http://www.trio-lighting.com)